

---

---

**Identification cards — Integrated circuit  
cards —**

**Part 3:  
Cards with contacts — Electrical  
interface and transmission protocols**

*Cartes d'identification — Cartes à circuit intégré —*

*Partie 3: Cartes à contacts — Interface électrique et protocoles  
de transmission*

**PDF disclaimer**

This PDF file may contain embedded typefaces. In accordance with Adobe's licensing policy, this file may be printed or viewed but shall not be edited unless the typefaces which are embedded are licensed to and installed on the computer performing the editing. In downloading this file, parties accept therein the responsibility of not infringing Adobe's licensing policy. The ISO Central Secretariat accepts no liability in this area.

Adobe is a trademark of Adobe Systems Incorporated.

Details of the software products used to create this PDF file can be found in the General Info relative to the file; the PDF-creation parameters were optimized for printing. Every care has been taken to ensure that the file is suitable for use by ISO member bodies. In the unlikely event that a problem relating to it is found, please inform the Central Secretariat at the address given below.

© ISO/IEC 2006

All rights reserved. Unless otherwise specified, no part of this publication may be reproduced or utilized in any form or by any means, electronic or mechanical, including photocopying and microfilm, without permission in writing from either ISO at the address below or ISO's member body in the country of the requester.

ISO copyright office  
Case postale 56 • CH-1211 Geneva 20  
Tel. + 41 22 749 01 11  
Fax + 41 22 749 09 47  
E-mail [copyright@iso.org](mailto:copyright@iso.org)  
Web [www.iso.org](http://www.iso.org)

Published in Switzerland

# Contents

Page

Foreword.....	iv
Introduction .....	v
1 Scope .....	1
2 Normative references .....	1
3 Terms and definitions.....	1
4 Symbols and abbreviated terms .....	3
5 Electrical characteristics .....	5
5.1 General.....	5
5.2 Contacts.....	6
6 Card operating procedure.....	9
6.1 Principles.....	9
6.2 Activation, resets and class selection.....	9
6.3 Information exchange.....	11
6.4 Deactivation.....	12
7 Asynchronous character .....	13
7.1 Elementary time unit.....	13
7.2 Character frame .....	13
7.3 Error signal and character repetition.....	14
8 Answer to reset.....	15
8.1 Characters and coding conventions.....	15
8.2 Answer-to-Reset .....	16
8.3 Global interface bytes .....	18
9 Protocol and parameters selection.....	20
9.1 PPS exchange .....	20
9.2 PPS request and response .....	20
9.3 Successful PPS exchange .....	21
10 Protocol T=0, half-duplex transmission of characters .....	22
10.1 Scope .....	22
10.2 Character level .....	22
10.3 Structure and processing of commands.....	22
11 Protocol T=1, half-duplex transmission of blocks .....	24
11.1 Scope and principles.....	24
11.2 Character frame .....	24
11.3 Block frame .....	24
11.4 Protocol parameters .....	27
11.5 Character component operation at data link layer.....	28
11.6 Block component operation at data link layer.....	28
12 Transmission of command-response pairs .....	32
12.1 Application protocol data units.....	32
12.2 Command-response pair transmission by T=0 .....	34
12.3 Command-response pair transmission by T=1 .....	40
Annex A (informative) Scenarios for T=1 .....	42
Bibliography .....	50

## Foreword

ISO (the International Organization for Standardization) and IEC (the International Electrotechnical Commission) form the specialized system for worldwide standardization. National bodies that are members of ISO or IEC participate in the development of International Standards through technical committees established by the respective organization to deal with particular fields of technical activity. ISO and IEC technical committees collaborate in fields of mutual interest. Other international organizations, governmental and non-governmental, in liaison with ISO and IEC, also take part in the work. In the field of information technology, ISO and IEC have established a joint technical committee, ISO/IEC JTC 1.

International Standards are drafted in accordance with the rules given in the ISO/IEC Directives, Part 2.

The main task of the joint technical committee is to prepare International Standards. Draft International Standards adopted by the joint technical committee are circulated to national bodies for voting. Publication as an International Standard requires approval by at least 75 % of the national bodies casting a vote.

ISO/IEC 7816-3 was prepared by Joint Technical Committee ISO/IEC JTC 1, *Information technology*, Subcommittee SC 17, *Cards and personal identification*.

This third edition cancels and replaces the second edition (ISO/IEC 7816-3:1997), which has been technically revised. It also incorporates the Amendment ISO/IEC 7816-3:1997/Amd.1:2002.

In addition, it incorporates material extracted from the first edition of Part 4 (ISO/IEC 7816-4:1995), so that the transmission protocols are no longer present in the second edition of Part 4 (ISO/IEC 7816-4:2005).

ISO/IEC 7816 consists of the following parts, under the general title *Identification cards — Integrated circuit cards*:

- *Part 1: Cards with contacts — Physical characteristics*
- *Part 2: Cards with contacts — Dimensions and location of the contacts*
- *Part 3: Cards with contacts — Electrical interface and transmission protocols*
- *Part 4: Organization, security and commands for interchange*
- *Part 5: Registration of application providers*
- *Part 6: Interindustry data elements for interchange*
- *Part 7: Interindustry commands for Structured Card Query Language (SCQL)*
- *Part 8: Commands for security operations*
- *Part 9: Commands for card management*
- *Part 10: Cards with contacts — Electronic signals and answer to reset for synchronous cards*
- *Part 11: Personal verification through biometric methods*
- *Part 12: Cards with contacts — USB electrical interface and operating procedures*
- *Part 13: Commands for application management in multi-application environment*
- *Part 15: Cryptographic information application*

## Introduction

ISO/IEC 7816 is a series of standards specifying integrated circuit cards and the use of such cards for interchange. These cards are identification cards intended for information exchange negotiated between the outside world and the integrated circuit in the card. As a result of an information exchange, the card delivers information (computation result, stored data), and/or modifies its content (data storage, event memorization).

Five parts are specific to cards with galvanic contacts and three of them specify electrical interfaces.

- ISO/IEC 7816-1 specifies physical characteristics for cards with contacts.
- ISO/IEC 7816-2 specifies dimensions and location of the contacts.
- ISO/IEC 7816-3 specifies electrical interface and transmission protocols for asynchronous cards.

**NOTE** The first and second editions of ISO/IEC 7816-3 specified an optional use of contact C6 to provide the card with programming power required to write or to erase internal non-volatile memory. As every card manufactured since 1990 internally generates programming power, this third edition deprecates this use, as well as the related indications in the Answer-to-Reset and the related controls in each transmission protocol.

- ISO/IEC 7816-10 specifies electrical interface and answer to reset for synchronous cards.
- ISO/IEC 7816-12 specifies electrical interface and operating procedures for USB cards.

All the other parts are independent of the physical interface technology. They apply to cards accessed by one or more of the following methods: contacts, close coupling and radio frequency.

- ISO/IEC 7816-4 specifies organization, security and commands for interchange.
- ISO/IEC 7816-5 specifies registration of application providers.
- ISO/IEC 7816-6 specifies interindustry data elements for interchange.
- ISO/IEC 7816-7 specifies commands for structured card query language.
- ISO/IEC 7816-8 specifies commands for security operations.
- ISO/IEC 7816-9 specifies commands for card management.
- ISO/IEC 7816-11 specifies personal verification through biometric methods.
- ISO/IEC 7816-13 specifies commands for application management in multi-application environment.
- ISO/IEC 7816-15 specifies cryptographic information application.

ISO/IEC 10536<sup>[3]</sup> specifies access by close coupling. ISO/IEC 14443<sup>[5]</sup> and ISO/IEC 15693<sup>[6]</sup> specify access by radio frequency. Such cards are also known as contactless cards.

## ISO/IEC 7816-3:2006(E)

ISO and IEC draw attention to the fact that it is claimed that compliance with this document may involve the use of patents.

ISO and IEC take no position concerning the evidence, validity and scope of these patent rights.

The holders of these patent rights have assured ISO and IEC that they are willing to negotiate licences under reasonable and non-discriminatory terms and conditions with applicants throughout the world. In this respect, the statements of the holders of these patent rights are registered with ISO and IEC. Information may be obtained from the following companies.

Patent holder	Patent number	Details	Foreign equivalents
Toshiba Corporation Intellectual Property Division 1-1, Shibaura 1-Chome Minato-ku, Tokyo 105-8001, Japan	JPN 2537199	<i>Integrated circuit card,</i> (priority date: 1986-06-20; publication date: 1996-07-08)	FRA 8708646, FRA 8717770, USA 4833595, USA 4901276
	USA 5161231	<i>Processing system which transmits a predetermined error code upon detection of an incorrect transmission code,</i> (priority date: 1991-03-12; publication date: 1992-11-03)	FRA 8713306, FRA 9209880

Attention is drawn to the possibility that some of the elements of this document may be the subject of patent rights other than those identified above. ISO and IEC shall not be held responsible for identifying any or all such patent rights.

# Identification cards — Integrated circuit cards —

## Part 3: Cards with contacts — Electrical interface and transmission protocols

### 1 Scope

This part of ISO/IEC 7816 specifies the power and signal structures, and information exchange between an integrated circuit card and an interface device such as a terminal.

It also covers signal rates, voltage levels, current values, parity convention, operating procedure, transmission mechanisms and communication with the card.

It does not cover information and instruction content, such as identification of issuers and users, services and limits, security features, journaling and instruction definitions.

### 2 Normative references

The following referenced documents are indispensable for the application of this document. For dated references, only the edition cited applies. For undated references, the latest edition of the referenced document (including any amendments) applies.

ISO/IEC 7816-2, *Identification cards — Integrated circuit cards — Part 2: Cards with contacts — Dimensions and location of the contacts*

ISO/IEC 7816-4, *Identification cards — Integrated circuit cards — Part 4: Organization, security and commands for interchange*

### 3 Terms and definitions

For the purposes of this document, the following terms and definitions apply.

#### 3.1

##### **block**

byte string comprising two or three fields defined as prologue field, information field and epilogue field

#### 3.2

##### **class of operating conditions**

set of values for voltage and current

#### 3.3

##### **cold reset**

first reset occurring after activation

#### 3.4

##### **destination node address**

portion of the node address byte, identifying the intended receiver of the block

- 3.5 elementary time unit**  
nominal duration of a moment within an asynchronous character
- 3.6 epilogue field**  
final field of a block, conveying the error detection code
- 3.7 identification card**  
card identifying its holder and issuer, which may carry data required as input for the intended use of the card and for transactions based thereon  
[ISO/IEC 7810<sup>[2]</sup>]
- 3.8 information block**  
block whose primary purpose is to convey application layer information
- 3.9 information field**  
field of a block, conveying data, generally application data
- 3.10 interface device**  
terminal, communication device or machine to which the card is electrically connected during operation
- 3.11 length byte**  
portion of the prologue field, encoding the number of bytes in the information field of the block
- 3.12 node address byte**  
portion of the prologue field, indicating both destination and source addresses of the block
- 3.13 operating card**  
card that can correctly carry out all its functions
- 3.14 procedure byte**  
byte transmitted by the card for indicating the progression of a T=0 command and controlling the exchange of data bytes
- 3.15 prologue field**  
first field of a block, consisting of three bytes defined as node address, protocol control and length
- 3.16 protocol control byte**  
portion of the prologue field, encoding transmission control information
- 3.17 receive ready block**  
block conveying the send-sequence number of the expected I-block, used as a positive or negative acknowledgment
- 3.18 redundancy code**  
content of the epilogue field, computed from all the bytes in the prologue field and in the information field



**3.19****source node address**

portion of the node address byte, identifying the transmitter of the block

**3.20****supervisory block**

block conveying transmission control information

**3.21****transmission control**

function used to control the data transmission between the interface device and the card, including block transmission with sequence control, synchronization and recovery of transmission errors

**3.22****warm reset**

any reset that is not a cold reset

## 4 Symbols and abbreviated terms

For the purposes of this document, the following symbols and abbreviated terms apply.

A, B, C	classes of operating conditions
APDU	application protocol data unit
<i>BGT</i>	block guard time
<i>BWI</i>	block waiting time integer
<i>BWT</i>	block waiting time
<i>CGT</i>	character guard time
$C_{IN}$	input capacitance
CLA	class byte
CLK	clock contact
$C_{OUT}$	output capacitance
CRC	cyclic redundancy code
<i>CWI</i>	character waiting time integer
<i>CWT</i>	character waiting time
(C(6) C(7))	value of the concatenation of bytes C(6) and C(7) (the first byte is the most significant byte)
<i>D</i>	baud rate adjustment integer
DAD	destination node address
<i>Dd, Di, Dn</i>	default values, indicated values and negotiated values of <i>D</i>
etu	elementary time unit
<i>F</i>	clock rate conversion integer
<i>f</i>	frequency value of the clock signal provided to the card by the interface device
<i>Fd, Fi, Fn</i>	default values, indicated values and negotiated values of <i>F</i>
GND	ground contact
<i>GT</i>	guard time

## ISO/IEC 7816-3:2006(E)

H	high state
I-block	information block
$I_{CC}$	current at VCC
IFS	maximum information field size
IFSC	IFS for the card
IFSD	IFS for the interface device
$I_{IH}$	high level input current
$I_{IL}$	low level input current
INF	information field
INS	instruction byte
$I_{OH}$	high level output current
$I_{OL}$	low level output current
I/O	input/output contact
L	low state
$L_c$ field	length field for coding number $N_c$
$L_e$ field	length field for coding number $N_e$
LEN	length byte
LRC	longitudinal redundancy code
$N$	extra guard time integer
NAD	node address byte
$N_a$	exact number of available data bytes
$N_c$	number of bytes in the command data field
$N_e$	maximum number of bytes expected in the response data field
$N_m$	number of remaining data bytes
$N_r$	number of bytes in the response data field
$N_x$	number of extra data bytes still available
OSI	open systems interconnection
PCB	protocol control byte
PPS	protocol and parameters selection
P1 P2	parameter bytes
R-block	receive ready block
RFU	reserved for future use
RST	reset contact
SAD	source node address
S-block	supervisory block
SPU	standard or proprietary use contact

state H	high electrical level
state L	low electrical level
SW1 SW2	status bytes
T	type
T=0	half duplex transmission of characters
T=1	half duplex transmission of blocks
TA, TB, ...	interface bytes
TCK	check character
$t_F$	fall time, from 90 % to 10 % of signal amplitude
TPDU	transmission protocol data unit
$t_R$	rise time, from 10 % to 90 % of signal amplitude
TS	initial character
T0	format byte
T <sub>1</sub> , T <sub>2</sub> , ...	historical bytes
$U_{CC}$	voltage at VCC
$U_{IH}$	high level input voltage
$U_{IL}$	low level input voltage
$U_{OH}$	high level output voltage
$U_{OL}$	low level output voltage
NOTE	In accordance with ISO 31 <sup>[1]</sup> , the symbols $U_{CC}$ , $U_{IH}$ , $U_{IL}$ , $U_{OH}$ and $U_{OL}$ replace the former symbols $V_{CC}$ , $V_{IH}$ , $V_{IL}$ , $V_{OH}$ and $V_{OL}$ .
VCC	supply power contact
$WI$	waiting time integer
$WT$	waiting time
WTX	waiting time extension
X	clock stop indicator
Y	class indicator
'XY'	notation using the hexadecimal digits '0' to '9' and 'A' to 'F', equal to XY to the base 16

## 5 Electrical characteristics

### 5.1 General

#### 5.1.1 Contact assignment

The dimensions and location of the contacts shall be as specified in ISO/IEC 7816-2.

## ISO/IEC 7816-3:2006(E)

This part of ISO/IEC 7816 supports at least the following contacts.

- C1: supply power input (VCC, see 5.2.1).
- C2: reset signal input (RST, see 5.2.2).
- C3: clock signal input (CLK, see 5.2.3).
- C5: ground (GND, reference voltage).
- C6: standard or proprietary use (SPU, see 5.2.4).
- C7: input/output for serial data (I/O, see 5.2.5).

NOTE This document deprecates the use of contact C6 to provide the card with programming power because every card manufactured since 1990 internally generates programming power.

### 5.1.2 Measurement conventions

By definition, when a card and an interface device are mechanically connected, each contact of the card and the corresponding contact of the interface device together form an “electrical circuit”.

All measurements on an electrical circuit are defined with respect to GND and in an ambient temperature range 0° C to 50° C. All currents flowing into the card are considered positive. All timings shall be measured with respect to the appropriate threshold levels.

By definition, an electrical circuit is “not active” when the voltage with respect to GND remains between 0 V and 0,4 V for currents less than 1 mA flowing into the interface device.

### 5.1.3 Classes of operating conditions

This document defines three classes of operating conditions, based on the nominal supply voltage provided to the card by the interface device through VCC.

- 5 V for class A.
- 3 V for class B.
- 1,8 V for class C.

The card shall support one or more classes. If the interface device applies a class supported by the card, then the card shall operate as specified.

- If the card supports more than one class, those classes shall be consecutive.
- If the interface device offers more than one class, the order in which those classes are applied is not within the scope of this document.

No card shall be damaged when the interface device applies a class not supported by the card (by definition, a damaged card no longer operates as specified or contains corrupt data).

## 5.2 Contacts

### 5.2.1 VCC (C1)

This contact is used to supply the card with power.

**Table 1 — Electrical characteristics of VCC under normal operating conditions**

Symbol	Conditions	Minimum	Maximum	Unit
$U_{CC}$	Class A	4,5	5,5	V
	Class B	2,7	3,3	
	Class C	1,62	1,98	
$I_{CC}$	Class A, at maximum allowed frequency		60	mA
	Class B, at maximum allowed frequency		50	
	Class C, at maximum allowed frequency		30	
	When the clock is stopped, see 6.3.2		0,5	

The current value is averaged over 1 ms.

The maximum current is defined for the card. The interface device shall be able to deliver this current within the range specified for the voltage value and may deliver more. The supply power shall maintain the voltage value within the specified range despite transient power consumption as defined in Table 2.

**Table 2 — Spikes on  $I_{CC}$** 

Class	Maximum charge <sup>a</sup>	Maximum duration	Maximum variation <sup>b</sup> of $I_{CC}$
A	20 nA.s	400 ns	100 mA
B	10 nA.s	400 ns	50 mA
C	6 nA.s	400 ns	30 mA

<sup>a</sup> The maximum charge is half the product of the maximum duration and the maximum variation.  
<sup>b</sup> The maximum variation is the difference in supply current with respect to the average value.

### 5.2.2 RST (C2)

This contact is used to provide the card with reset signal. See 6.2.2 (cold reset) and 6.2.3 (warm reset).

**Table 3 — Electrical characteristics of RST under normal operating conditions**

Symbol	Conditions	Minimum	Maximum	Unit
$U_{IH}$		0,8 $U_{CC}$	$U_{CC}$	V
$I_{IH}$	$U_{IH}$	-20	+150	$\mu$ A
$U_{IL}$		0	0,12 $U_{CC}$	V
$I_{IL}$	$U_{IL}$	-200	+20	$\mu$ A
$t_R$ $t_F$	$C_{IN} = 30$ pF		1	$\mu$ s

The voltage shall remain between - 0,3 V and  $U_{CC} + 0,3$  V.

### 5.2.3 CLK (C3)

This contact is used to provide the card with clock signal. The actual value of the frequency of the clock signal is denoted  $f$ . The minimum value shall be 1 MHz. At least during activation (see 6.2.1) and cold reset (see 6.2.2), the maximum value shall be 5 MHz. For the maximum value supported by the card, see Table 7.

Unless otherwise specified, the duty cycle of the clock signal shall be between 40 % and 60 % of the cycle during stable operation. When switching the frequency from one value to another, care should be taken to ensure that no pulse is shorter than 40 % of the shortest cycle allowed by the card (see maximum frequency in Table 7). No information shall be exchanged when switching the frequency value. Two different times are recommended for switching the frequency value, either

- after completion of an answer to reset, see 8.1, while the card is waiting for a character, or
- after completion of a successful PPS exchange, see 9.3, while the card is waiting for a character.

**Table 4 — Electrical characteristics of CLK under normal operating conditions**

Symbol	Conditions	Minimum	Maximum	Unit
$U_{IH}$		$0,7 U_{CC}$	$U_{CC}$	V
$I_{IH}$	$U_{IH}$	-20	+100	$\mu A$
$U_{IL}$	Class A and class B	0	0,5	V
$U_{IL}$	Class C	0	$0,2 U_{CC}$	V
$I_{IL}$	$U_{IL}$	-100	+20	$\mu A$
$t_R$ $t_F$	$C_{IN} = 30$ pF		9 % of cycle	

The voltage shall remain between  $-0,3$  V and  $U_{CC} + 0,3$  V.

**5.2.4 SPU (C6)**

This contact is available for either standard or proprietary use, as input and/or output.

Depending upon whether the card uses SPU or not, the first TB for T=15 shall be present or absent in the Answer-to-Reset: this global interface byte (see 8.3) indicates whether the use is standard or proprietary. ISO/IEC JTC 1/SC 17 reserves the standard use for future use.

When the card is powered through VCC, if contact C6 is connected in the interface device, then the voltage shall remain between  $-0,3$  V and  $U_{CC} + 0,3$  V.

No card shall be damaged by an interface device where contact C6 is connected to VCC or GND as such an interface device complies with the previous edition (ISO/IEC 7816-3:1997).

**5.2.5 I/O (C7)**

This contact is used as input (reception mode) or output (transmission mode). The information exchange uses two states of the electrical circuit as follows:

- state H if the card and the interface device are in reception mode or if the transmitter imposes this state;
- state L if the transmitter imposes this state.

When both the card and the interface device are in reception mode, the electrical circuit shall be at state H. When the card and the interface device are in non-matched transmission mode, the state may be indeterminate. During operation, the interface device and the card shall not be simultaneously in transmission mode.

The interface device shall be able to support the defined range of input currents when the input voltages are within the allowed range. The impedance presented by the interface device to the card shall allow the card to keep the output voltages within the defined range.

**Table 5 — Electrical characteristics of I/O under normal operating conditions**

Symbol	Conditions	Minimum	Maximum	Unit
$U_{IH}$		$0,7 U_{CC}$	$U_{CC}$	V
$I_{IH}$	$U_{IH}$	-300	+20	$\mu A$
$U_{IL}$		0	$0,15 U_{CC}$	V
$I_{IL}$	$U_{IL}$	-1000	+20	$\mu A$
$U_{OH}$	External pull-up resistor: $20$ k $\Omega$ to $U_{CC}$	$0,7 U_{CC}$	$U_{CC}$	V
$I_{OH}$	$U_{OH}$ and external pull-up resistor: $20$ k $\Omega$ to $U_{CC}$		+20	$\mu A$
$U_{OL}$	$I_{OL} = 1$ mA for class A <sup>a</sup> and class B <sup>a</sup> $I_{OL} = 500$ $\mu A$ for class C <sup>a</sup>	0	$0,15 U_{CC}$	V
$t_R$ $t_F$	$C_{IN} = 30$ pF; $C_{OUT} = 30$ pF		1	$\mu s$

The voltage shall remain between  $-0,3$  V and  $U_{CC} + 0,3$  V.

<sup>a</sup> Interface device implementations should not require the card to sink more than 500  $\mu A$ .

## 6 Card operating procedure

### 6.1 Principles

The electrical circuits shall remain not active until the contacts of the card are mechanically connected to the contacts of the interface device. The interaction between the interface device and the card shall be conducted through the following sequence of operations.

- The interface device shall apply a class of operating conditions to the electrical circuits, i.e., activation, cold reset and possibly one or more warm resets. If the card supports the class, it shall answer to reset according to clause 8. The interface device ends up with a complete and valid Answer-to-Reset and a class of operating conditions. The interface device shall be able to repeat the entire operation.
- For exchanging information, the card and the interface device shall agree on a transmission protocol and values of transmission parameters. Clause 10 specifies T=0, the half-duplex transmission of characters with the interface device as the master. Clause 11 specifies T=1, the half-duplex transmission of blocks. Clause 12 specifies the transmission of command-response pairs by T=0 and by T=1. When no transmission is expected from the card (e.g., after processing a command-response pair and before initiating the next one), the interface device may stop the clock signal if the card supports clock stop.
- The interface device shall perform a deactivation.

The deactivation should be completed before the mechanical disconnection between the contacts of the card and the contacts of the interface device.

### 6.2 Activation, resets and class selection

#### 6.2.1 Activation

In order to initiate an interaction with a mechanically connected card, the interface device shall activate the electrical circuits according to a class of operating conditions: A, B or C, see 5.1.3, in the following order.

- RST shall be put to state L, see 5.2.2.
- VCC shall be powered, see 5.2.1.
- I/O in the interface device shall be put in reception mode, see 5.2.5. The interface device shall ignore the state on I/O during activation.
- CLK shall be provided with a clock signal, see 5.2.3.

NOTE 1 The delays between powering VCC, setting I/O in reception mode and providing the clock signal on CLK are not defined.

NOTE 2 The interface device may perform a deactivation due to short circuits.

Figure 1 summarizes activation (before time  $T_a$ ) and cold reset (after time  $T_a$ ).

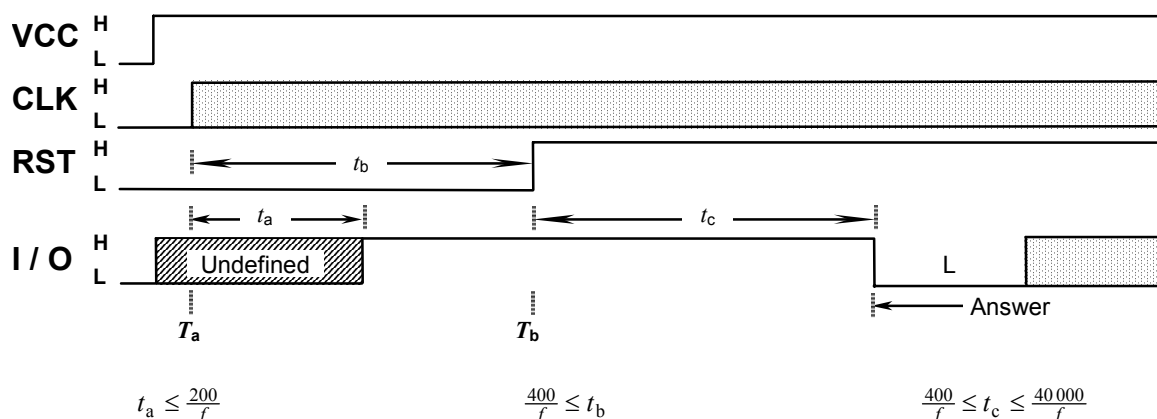

Figure 1 — Activation and cold reset

**6.2.2 Cold reset**

By the end of activation (RST in state L, VCC powered, I/O in reception mode in the interface device, CLK provided with a suitable and stable clock signal), the card is ready for a cold reset. The internal state of the card is not defined before a cold reset.

According to Figure 1, the clock signal is applied to CLK at time  $T_a$ . The card shall set I/O to state H within 200 clock cycles (delay  $t_a$ ) after the clock signal is applied to CLK (at time  $T_a + t_a$ ). The cold reset results from maintaining RST at state L for at least 400 clock cycles (delay  $t_b$ ) after the clock signal is applied to CLK (at time  $T_a + t_b$ ). The interface device shall ignore the state on I/O while RST is at state L.

At time  $T_b$ , RST is put to state H. The answer on I/O shall begin between 400 and 40 000 clock cycles (delay  $t_c$ ) after the rising edge of the signal on RST (at time  $T_b + t_c$ ). If the answer does not begin within 40 000 clock cycles with RST at state H, the interface device shall perform a deactivation.

**6.2.3 Warm reset**

As the answer to a warm reset may differ from the answer to the previous reset, the interface device may warm reset the card at any time, even during the answer to reset, but not before reception of the mandatory characters TS and T0 (see 8.1). The warm reset shall not be initiated less than 4 464 (= 12 × 372) clock cycles after the leading edge of character T0.

**WARNING** A warm reset initiated during the answer to reset may damage a card compliant with the previous edition (ISO/IEC 7816-3:1997).

According to Figure 2, the interface device initiates a warm reset (at time  $T_c$ ) by putting RST to state L for at least 400 clock cycles (delay  $t_e$ ) while VCC remains powered and CLK provided with a suitable and stable clock signal. The card shall set I/O to state H within 200 clock cycles (delay  $t_d$ ) after state L is applied to RST (at time  $T_c + t_d$ ). The interface device shall ignore the state on I/O while RST is at state L.

At time  $T_d$ , RST is put to state H. The answer on I/O shall begin between 400 and 40 000 clock cycles (delay  $t_f$ ) after the rising edge of the signal on RST (at time  $T_d + t_f$ ). If the answer does not begin within 40 000 clock cycles with RST at state H, the interface device shall perform a deactivation.

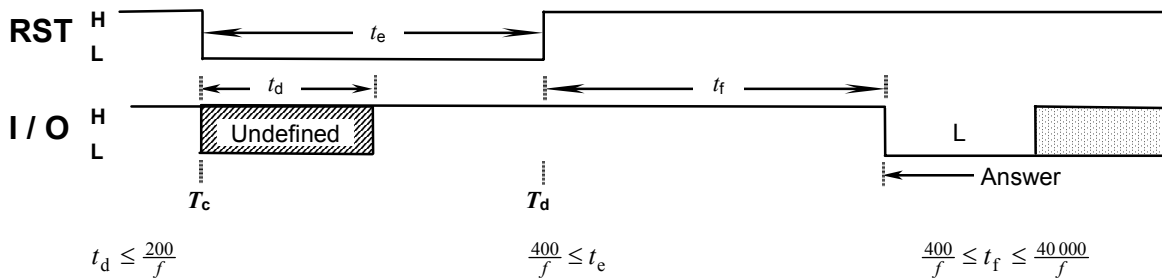

**Figure 2 — Warm reset**

**6.2.4 Class selection**

Figure 3 illustrates the principles of selection of the class of operating conditions. The figure is not exhaustive.

- If the Answer-to-Reset carries a class indicator indicating the class being applied (see the first TA for T=15 in 8.2), then normal operation may continue. Alternatively, the interface device may perform a deactivation and after a delay of at least 10 ms, apply another class supported by the card.
- If the Answer-to-Reset carries no class indicator, then the interface device shall maintain the current class. If, after completion of the answer to reset, the card does not operate, then the interface device shall perform a deactivation and after a delay of at least 10 ms, may apply another class.
- If the card does not answer to reset, then the interface device shall perform a deactivation and either
  - after a delay of at least 10 ms, apply another class, if any, or
  - abort the selection process.

After abortion of a selection process, the interface device may initiate another selection process.



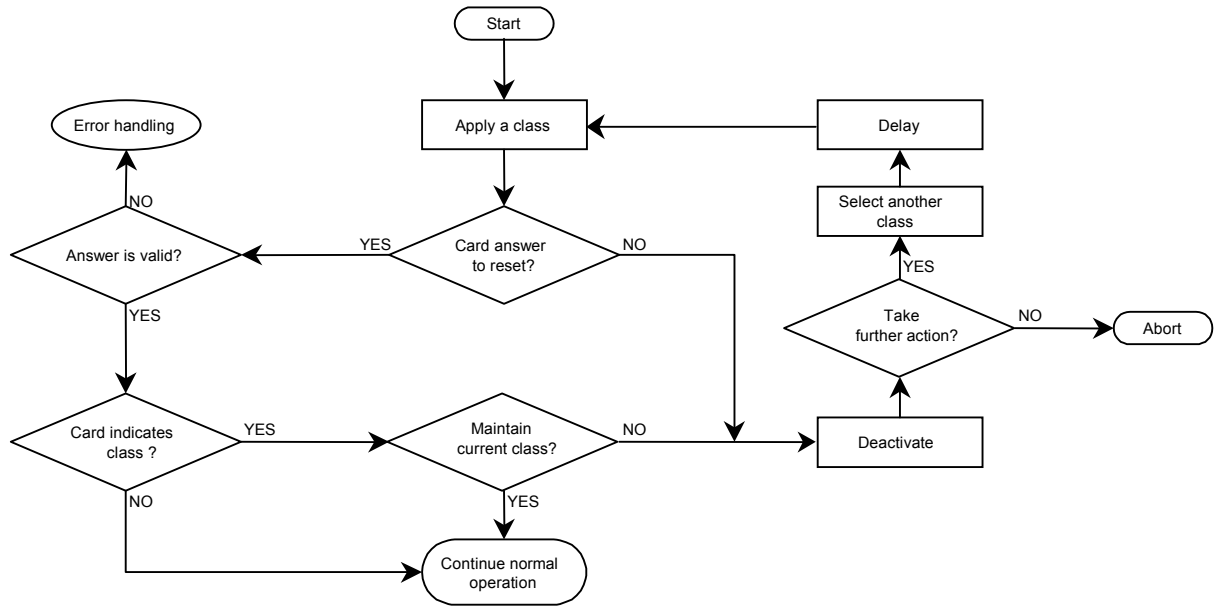

Figure 3 — Class selection by the interface device

Once selected, the class shall not be changed during normal operation. For changing it, the interface device shall perform a deactivation and after a delay of at least 10 ms, apply another class.

### 6.3 Information exchange

#### 6.3.1 Selection of transmission parameters and protocol

After completion of the answer to reset, the card shall wait for characters from the interface device: their transmission is governed by transmission parameters (see 7.1); their interpretation is governed by a protocol (see 9, 10 and 11). Figure 4 illustrates the principles of selection of transmission parameters and protocol.

- If TA<sub>2</sub> (see 8.3) is present in the Answer-to-Reset (card in specific mode), then the interface device shall start the specific transmission protocol using the specific values of the transmission parameters.
- Otherwise (card in negotiable mode), for the transmission parameters, the values used during the answer to reset (i.e., the default values of the transmission parameters, see 8.1) shall continue to apply as follows.
  - If the value of the first character received by the card is 'FF', then the interface device shall have started a PPS exchange (see 9); the default values of the transmission parameters shall continue to apply until completion of a successful PPS exchange (see 9.3), after what the interface device shall start the negotiated transmission protocol using the negotiated values of the transmission parameters.
  - Otherwise, the interface device shall have started the “first offered transmission protocol” (see TD<sub>1</sub> in 8.2.3). The interface device shall do so when the card offers only one transmission protocol and only the default values of the transmission parameters. Such a card need not support PPS exchange.

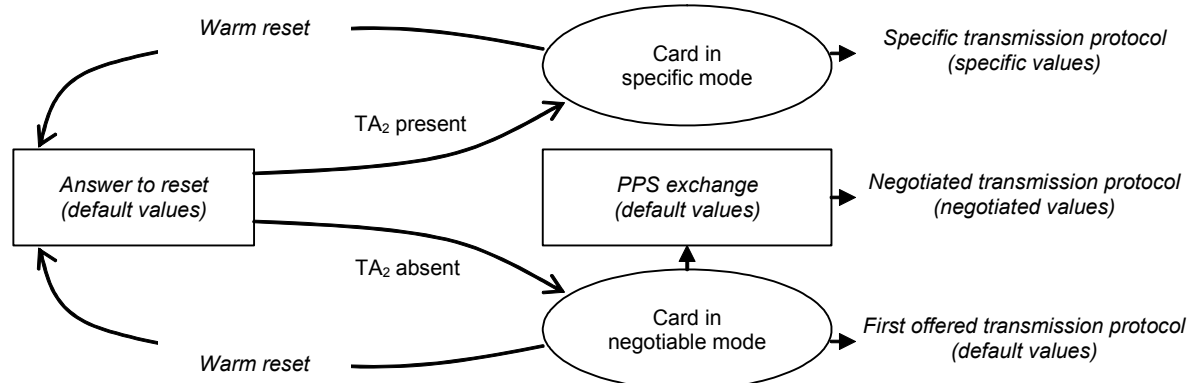

Figure 4 — Selection of transmission parameters and protocol

NOTE 1 The value of PPSS ('FF', see 9.2) is invalid for CLA (T=0, see 10.3.2) and for NAD (T=1, see 11.3.2.1).

NOTE 2 In a multi-protocol card offering T=0 in negotiable mode, only T=0 can be "implicitly" selected.

NOTE 3 An interface device facing a card in negotiable mode and supporting neither PPS exchange nor the "first offered transmission protocol" can perform either a warm reset or a deactivation.

NOTE 4 A card transmitting character TA<sub>2</sub> to an interface device not aware of the existence of specific mode cannot rely on a warm reset to switch the mode.

NOTE 5 An interface device having detected character TA<sub>2</sub> should not initiate a warm reset before it detects either an unsupported value in the received characters, or an overrun of WT (see 7.2).

**6.3.2 Clock stop**

For cards supporting clock stop, when the interface device expects no transmission from the card and when I/O has remained at state H for at least 1 860 clock cycles (delay  $t_g$ ), then according to Figure 5, the interface device may stop the clock on CLK (at time  $T_e$ ) while VCC remains powered and RST at state H.

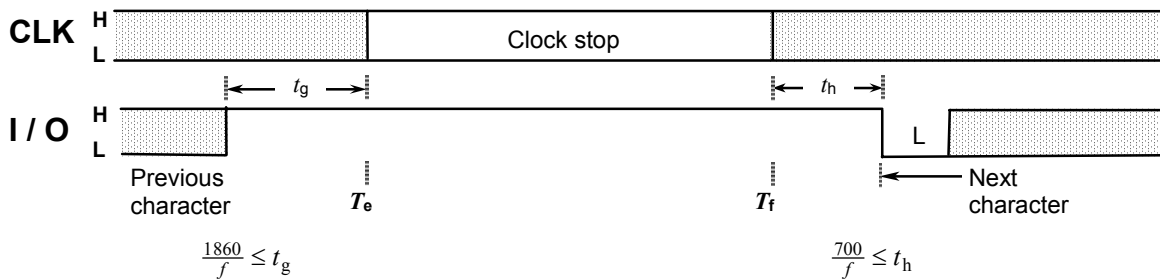

**Figure 5 — Clock stop**

When the clock is stopped (from time  $T_e$  to time  $T_f$ ), CLK shall be maintained either at state H or at state L according to the clock stop indicator X defined in 8.3.

At time  $T_f$ , the interface device restarts the clock and the information exchange on I/O may continue after at least 700 clock cycles (at time  $T_f + t_h$ ).

**6.4 Deactivation**

When information exchange is completed or aborted (e.g., unresponsive card, detection of card removal), the interface device shall deactivate the electrical circuits in the following order (see Figure 6).

- RST shall be put to state L.
- CLK shall be put to state L (unless the clock is already stopped at state L).
- I/O shall be put to state L.
- VCC shall be deactivated.

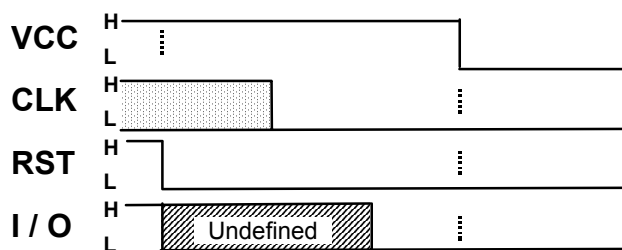

**Figure 6 — Deactivation**

## 7 Asynchronous character

### 7.1 Elementary time unit

The nominal duration of one moment on the electrical circuit I/O is named “elementary time unit” and denoted etu. The etu shall be equal to  $F/D$  clock cycles on the electrical circuit CLK where  $F$  and  $D$  are the transmission parameters:  $F$  is the clock rate conversion integer and  $D$  the baud rate adjustment integer.

$$1 \text{ etu} = \frac{F}{D} \times \frac{1}{f}$$

The values of the transmission parameters shall be as specified in 6.3.1.

### 7.2 Character frame

According to Figure 7, a character consists of ten consecutive moments numbered 1 to 10. Each moment is either at state H or at state L.

- Before moment 1, the electrical circuit I/O shall be at state H.
- Moment 1 shall be at state L. It is the character start.
- Moments 2 to 9 shall encode a byte according to a coding convention (see TS in 8.1).
- Moment 10 shall encode the character parity (see TS in 8.1).
- After moment 10, both the card and the interface device shall remain in reception mode (in error-free operation) for a certain time of “pause”, so that the electrical circuit I/O remains at state H.

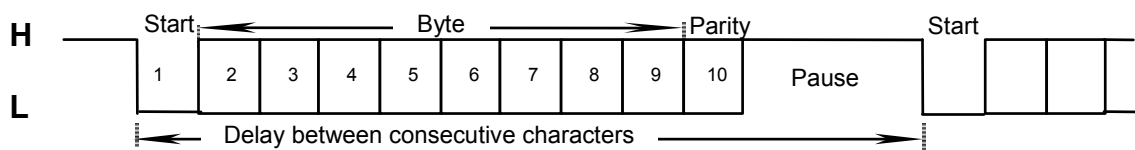

Figure 7 — Character frame

Figure 8 illustrates character timings: even with a maximum shift between the receiver time origin and the transmitter time origin, the reception windows shall be all distinct from the transition windows.

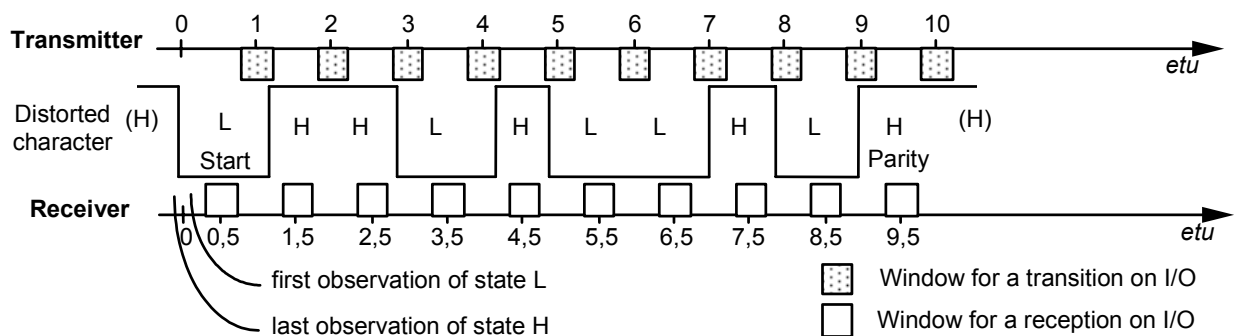

Figure 8 — Character timings

Within every character, if the state changes at the end of moment  $n$  for any  $n$  from 1 to 10, then the delay from the character leading edge to the trailing edge of moment  $n$  shall be  $(n \pm 0,2)$  etu.

When searching for a character, the receiver periodically samples the electrical circuit I/O. While the transmitter time origin is the character leading edge, the receiver time origin is the mean between the last observation of state H and the first observation of state L: the shift between time origins is at most half the sampling time. The sampling time shall be less than 0,2 etu.

The receiver shall confirm the start moment before 0,7 etu (in receiver time). The receiver shall read the second moment at  $(1,5 \pm 0,2)$  etu, the third moment at  $(2,5 \pm 0,2)$  etu, ... the ninth moment at  $(8,5 \pm 0,2)$  etu and the parity moment at  $(9,5 \pm 0,2)$  etu. Character parity is checked on the fly.

The minimum delay between the leading edges of two consecutive characters is named “guard time” and denoted *GT*.

The maximum delay between the leading edge of a character transmitted by the card and the leading edge of the previous character (transmitted by the card or the interface device) is named “waiting time” and denoted *WT*. It allows detecting, e.g., an unresponsive card.

NOTE Throughout this document, the guard/waiting times are minimum/maximum delays between the leading edges of consecutive characters.

### 7.3 Error signal and character repetition

The use of the error signal and character repetition is protocol dependent; see 8.1, 9.1, 10.2 and 11.2.

As shown in Figure 9, when character parity is incorrect, the receiver shall transmit an error signal on the electrical circuit I/O. Then the receiver shall expect a repetition of the character.

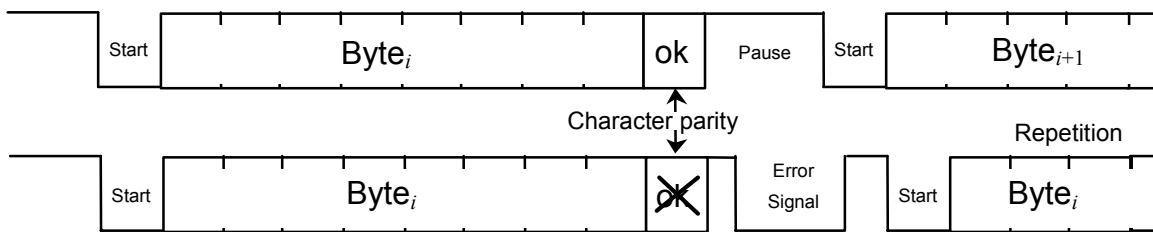

Figure 9 — Character transmission and repetition diagram

Figure 10 illustrates error signal timings.

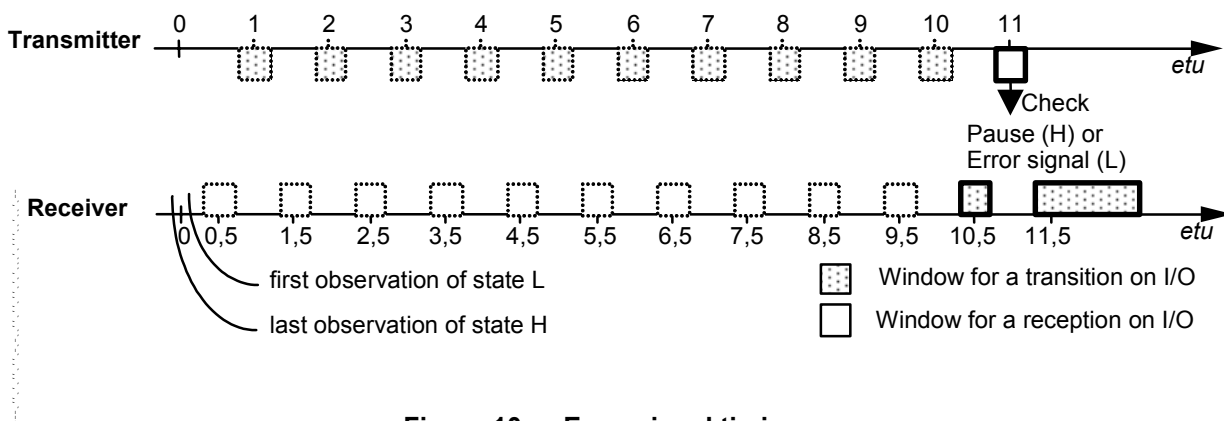

Figure 10 — Error signal timings

- To signal an error, the receiver shall put I/O to state L at  $(10,5 \pm 0,2)$  etu in receiver time for one etu minimum, two etu maximum.
- To detect an error signal, the transmitter shall read I/O at  $(11 \pm 0,2)$  etu after the character leading edge.
  - The correct reception is assumed if the state is H.
  - The incorrect reception is assumed if the state is L. After a delay of at least two etu from the detection of the error signal, the transmitter shall repeat the character.

If either the card or the interface device provides no character repetition, it ignores and shall not suffer damage from the incoming error signal.

## 8 Answer to reset

### 8.1 Characters and coding conventions

The etu initially used by the card shall be equal to 372 clock cycles (i.e., during the answer to reset, the values of the transmission parameters are the default values  $Fd = 372$  and  $Dd = 1$ ). See TS below for an alternate measurement of this etu. The character frame shall be as specified in 7.2 with  $GT = 12$  etu and  $WT = 9\,600$  etu. The error signal and character repetition according to 7.3 is mandatory for the cards offering  $T=0$ ; it is optional for the interface devices and for other cards.

Figure 11 shows the first character named “initial character” and denoted TS, and the beginning of the second character named “format character” and denoted T0.

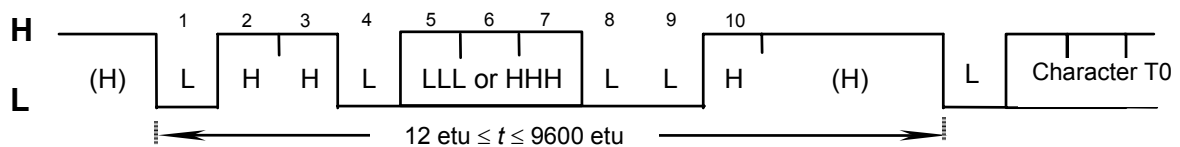

Figure 11 — Initial character TS

The initial character TS shall be as follows.

- The pattern of moments 1 to 4 shall be LHHL. The sequence (H) LHHL is a synchronization pattern. When taking one third of the delay between the two falling edges as an alternate measurement of the etu initially used by the card, the transmission and reception mechanisms in the card shall be consistent with the timings specified in 7.2 and 7.3.
- The pattern of moments 5 to 7 shall be either LLL or HHH. It indicates a convention to encode or to decode a byte (i.e., eight bits from the most significant bit (msb) to the least significant bit (lsb) with values 0 and 1) in every subsequent character (i.e., ten consecutive moments numbered 1 to 10 at states L and H).
- The pattern of moments 8 to 10 shall be LLH.

The initial character TS has two possible patterns.

- (H) LHHL LLL LLH sets up the inverse convention: state L encodes value 1 and moment 2 conveys the most significant bit (msb first). When decoded by inverse convention, the conveyed byte is equal to '3F'.
- (H) LHHL HHH LLH sets up the direct convention: state H encodes value 1 and moment 2 conveys the least significant bit (lsb first). When decoded by direct convention, the conveyed byte is equal to '3B'.

Character parity is correct when there is an even number of bits set to 1 in the nine moments 2 to 10.

The card uses either coding convention. The interface device shall support both coding conventions.

The initial character TS is followed by a sequence of at most 32 characters.

- Denoted T0, the format character is mandatory.
- Denoted TA TB TC TD, the interface characters are optional. The presence of interface characters is indicated by a bitmap technique initiated by the format character T0.
- Denoted  $T_1 T_2 \dots T_K$ , the historical characters are optional. The presence of historical characters depends upon a number  $K$  encoded in the format character T0.
- Denoted TCK, the check character is conditional. The presence of the check character depends upon the types T encoded in some interface characters TD.

By definition, the answer to reset is completed 12 etu after the leading edge of the last character of the sequence. By definition, the Answer-to-Reset is the value of the byte string (at most 32 bytes) encoded in that sequence of characters.

8.2 Answer-to-Reset

8.2.1 General configuration

Figure 12 shows the byte frame as used hereafter. The byte consists of eight bits numbered 8 to 1 with values 0 or 1; bit 8 is the most significant bit (msb) and bit 1 the least significant bit (lsb).

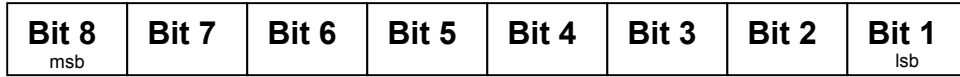

Figure 12 — Byte frame

Table 6 illustrates the Answer-to-Reset (a string of at most 32 bytes). For notation simplicity, each one of T0 TA TB TC TD ... T<sub>1</sub> T<sub>2</sub> ... T<sub>K</sub> and TCK hereafter also denotes the byte conveyed in the respective character.

Table 6 — Answer-to-Reset

	<b>Format byte T0</b> (mandatory)		Encodes $Y_1$ and $K$
	<b>Interface bytes</b> (optional)		
	<b>TA<sub>1</sub></b>	Global, encodes $F_i$ and $D_i$	
	<b>TB<sub>1</sub></b>	Global, deprecated	
	<b>TC<sub>1</sub></b>	Global, encodes $N$	
	<b>TD<sub>1</sub></b>	Structural, encodes $Y_2$ and $T$	
	<b>TA<sub>2</sub></b>	Global, specific mode byte	
	<b>TB<sub>2</sub></b>	Global, deprecated	
	<b>TC<sub>2</sub></b>	Specific to T=0, see 10.2	
	<b>TD<sub>2</sub></b>	Structural, encodes $Y_3$ and $T$	
For $i > 2$ ,			
<b>TD<sub>i-1</sub></b>	Structural, encodes $Y_i$ and $T$		
<b>TA<sub>i</sub></b>	— Specific to T after T from 0 to 14 in TD <sub>i-1</sub>		
<b>TB<sub>i</sub></b>	— Global after T=15 in TD <sub>i-1</sub>		
<b>TC<sub>i</sub></b>			
<b>TD<sub>i</sub></b>	Structural, encodes $Y_{i+1}$ and $T$		
<b>Historical bytes</b> (optional)			
<b>T<sub>1</sub></b>	See ISO/IEC 7816-4		
<b>T<sub>2</sub></b>			
...			
<b>T<sub>K</sub></b>			
<b>Check byte TCK</b> (conditional)			

### 8.2.2 Format byte T0

Figure 13 shows the format byte T0.

- Bits 8 to 5 form an indicator  $Y_1$ .
- Bits 4 to 1 encode a number  $K$  from 0 to 15.

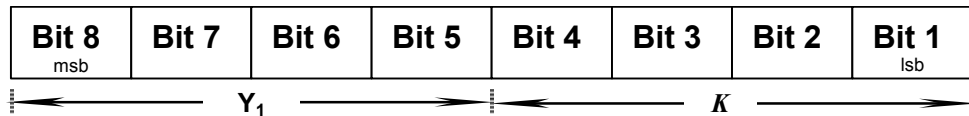

Figure 13 — Coding of T0

### 8.2.3 Interface bytes TA TB TC TD

Figure 14 shows the interface byte  $TD_i$ . Each interface byte TD is structural.

- Bits 8 to 5 form an indicator  $Y_{i+1}$ .
- Bits 4 to 1 encode a type T from 0 to 15.

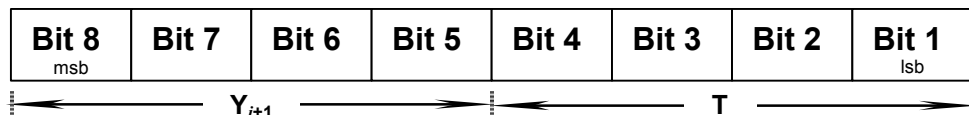

Figure 14 — Coding of  $TD_i$

Therefore T0 conveys  $Y_1$ ;  $TD_1$  conveys  $Y_2$ ;  $TD_2$  conveys  $Y_3$ , and so on. In the byte conveying the indicator  $Y_i$ , bits 8 to 5 state whether  $TA_i$  for bit 5,  $TB_i$  for bit 6,  $TC_i$  for bit 7,  $TD_i$  for bit 8 are present or absent (depending on whether the relevant bit is set to 1 or 0) in this order after the byte conveying  $Y_i$ .

If  $TD_i$  is absent, then  $TA_{i+1}$ ,  $TB_{i+1}$ ,  $TC_{i+1}$  and  $TD_{i+1}$  are also absent.

The type T refers to a transmission protocol and/or qualifies interface bytes.

- T=0 refers to the half-duplex transmission of characters specified in clause 10.
- T=1 refers to the half-duplex transmission of blocks specified in clause 11.
- T=2 and T=3 are reserved for future full-duplex operations.
- T=4 is reserved for an enhanced half-duplex transmission of characters.
- T=5 to T=13 are reserved for future use by ISO/IEC JTC 1/SC 17.
- T=14 refers to transmission protocols not standardized by ISO/IEC JTC 1/SC 17.
- T=15 does not refer to a transmission protocol, but only qualifies global interface bytes.

NOTE In  $TA_2$  (see 8.2) and PPS0 (see 9.2), bits 4 to 1 also encode a type T.

If  $TD_1$ ,  $TD_2$  and so on are present, the encoded types T shall be in ascending numerical order. If present, T=0 shall be first, T=15 shall be last. T=15 is invalid in  $TD_1$ .

The “first offered transmission protocol” is defined as follows.

- If  $TD_1$  is present, then it encodes the first offered protocol T.
- If  $TD_1$  is absent, then the only offer is T=0.

Each interface byte TA, TB or TC is either global or specific.

- Global interface bytes refer to parameters of the integrated circuit within the card, see 8.3.
- Specific interface bytes refer to parameters of a transmission protocol offered by the card.

TA<sub>1</sub>, TB<sub>1</sub>, TC<sub>1</sub>, TA<sub>2</sub> and TB<sub>2</sub> are global. TC<sub>2</sub> is specific to T=0, see 10.2.

The interpretation of TA<sub>*i*</sub>, TB<sub>*i*</sub>, TC<sub>*i*</sub>, for *i* > 2 depends on the type T encoded in TD<sub>*i-1*</sub>.

- After T from 0 to 14, TA<sub>*i*</sub>, TB<sub>*i*</sub> and TC<sub>*i*</sub> are specific to the transmission protocol T.
- After T=15, TA<sub>*i*</sub>, TB<sub>*i*</sub> and TC<sub>*i*</sub> are global.

If more than three interface bytes TA<sub>*i*</sub>, TB<sub>*i*</sub>, TC<sub>*i*</sub>, TA<sub>*i+1*</sub>, TB<sub>*i+1*</sub>, TC<sub>*i+1*</sub> ... are defined for the same type T, then each one is unambiguously identified by its position after the first, the second ... occurrence of T in TD<sub>*i-1*</sub> for *i* > 2. Consequently, for each type T, the first TA, TB, TC, the second TA, TB, TC, and so on, are available.

NOTE The combination of the type T with the bitmap technique allows transmitting only useful interface bytes and when needed, to use default values for parameters corresponding to absent interface bytes.

For example, clause 11.4 specifies three interface bytes specific to T=1, namely the first TA, TB and TC for T=1. If needed, such a byte shall be transmitted respectively as TA<sub>3</sub>, TB<sub>3</sub> and TC<sub>3</sub> after TD<sub>2</sub> indicating T=1. Depending on whether the card also offers T=0 or not, TD<sub>1</sub> shall indicate either T=0 or T=1.

**8.2.4 Historical bytes T<sub>1</sub> T<sub>2</sub> ... T<sub>K</sub>**

The historical bytes describe operating characteristics of the card. Their structure and content shall be as specified in ISO/IEC 7816-4.

If *K* is not zero, then the Answer-to-Reset continues on *K* (at most 15) historical bytes T<sub>1</sub> T<sub>2</sub> ... T<sub>K</sub>.

**8.2.5 Check byte TCK**

If only T=0 is indicated, possibly by default, then TCK shall be absent. If T=0 and T=15 are present and in all the other cases, TCK shall be present. When TCK is present, exclusive-oring all the bytes T0 to TCK inclusive shall give '00'. Any other value is invalid.

**8.3 Global interface bytes**

This clause specifies the content of the global interface bytes TA<sub>1</sub>, TB<sub>1</sub>, TC<sub>1</sub>, TA<sub>2</sub>, TB<sub>2</sub>, the first TA for T=15 and the first TB for T=15.

- If present, such a byte shall be interpreted in order to process correctly any transmission protocol.
- If such a byte is absent, then when needed, default values shall be used for the relevant parameters.

ISO/IEC JTC 1/SC 17 reserves for future use all the global interface bytes not defined in this clause and all the unused values of the global interface bytes defined in this clause.

TA<sub>1</sub> encodes the indicated value of the clock rate conversion integer (*Fi*), the indicated value of the baud rate adjustment integer (*Di*) and the maximum value of the frequency supported by the card (*f*(max.)). The default values are *Fi* = 372, *Di* = 1 and *f*(max.) = 5 MHz. For the use of *Fi* and *Di*, see 7.1, TC<sub>1</sub> and TA<sub>2</sub> below, 9.2 and 10.2. For the use of *f*(max.), see 5.2.3.

- According to Table 7, bits 8 to 5 encode *Fi* and *f*(max.).

**Table 7 — *Fi* and *f*(max.)**

<b>Bits 8 to 5</b>	0000	0001	0010	0011	0100	0101	0110	0111
<i>Fi</i>	372	372	558	744	1116	1488	1860	RFU
<i>f</i> (max.) MHz	4	5	6	8	12	16	20	—
<b>Bits 8 to 5</b>	1000	1001	1010	1011	1100	1101	1110	1111
<i>Fi</i>	RFU	512	768	1024	1536	2048	RFU	RFU
<i>f</i> (max.) MHz	—	5	7,5	10	15	20	—	—



— According to Table 8, bits 4 to 1 encode  $D_i$ .

**Table 8 —  $D_i$**

<b>Bits 4 to 1</b>	0000	0001	0010	0011	0100	0101	0110	0111
<b><math>D_i</math></b>	RFU	1	2	4	8	16	32	64
<b>Bits 4 to 1</b>	1000	1001	1010	1011	1100	1101	1110	1111
<b><math>D_i</math></b>	12	20	RFU	RFU	RFU	RFU	RFU	RFU

**TB<sub>1</sub>** and **TB<sub>2</sub>** are deprecated. The card should not transmit them. The interface device shall ignore them.

NOTE The first two editions of ISO/IEC 7816-3 specified TB<sub>1</sub> and TB<sub>2</sub> to fix electrical parameters of the integrated circuit for the deprecated use of contact C6 (see 5.1.1).

**TC<sub>1</sub>** encodes the extra guard time integer ( $N$ ) from 0 to 255 over the eight bits. The default value is  $N = 0$ .

— If  $N = 0$  to 254, then before being ready to receive the next character, the card requires the following delay from the leading edge of the previous character (transmitted by the card or the interface device).

$$GT = 12 \text{ etu} + R \times \frac{N}{f}$$

- If T=15 is absent in the Answer-to-Reset, then  $R = F / D$ , i.e., the integers used for computing the etu.
- If T=15 is present in the Answer-to-Reset, then  $R = F_i / D_i$ , i.e., the integers defined above by TA<sub>1</sub>.

No extra guard time is used to transmit characters from the card:  $GT = 12 \text{ etu}$ .

— The use of  $N = 255$  is protocol dependent:  $GT = 12 \text{ etu}$  in PPS (see 9) and in T=0 (see 10). For the use of  $N = 255$  in T=1, see 11.2.

**TA<sub>2</sub>** is the specific mode byte as shown in Figure 15. For the use of TA<sub>2</sub>, see 6.3.1 and 7.1.

— Bit 8 indicates the ability for changing the negotiable/specific mode:

- capable to change if bit 8 is set to 0;
- unable to change if bit 8 is set to 1.

— Bits 7 and 6 are reserved for future use (set to 0 when not used).

— Bit 5 indicates the definition of the parameters  $F$  and  $D$ .

- If bit 5 is set to 0, then the integers  $F_i$  and  $D_i$  defined above by TA<sub>1</sub> shall apply.
- If bit 5 is set to 1, then implicit values (not defined by the interface bytes) shall apply.

— Bits 4 to 1 encode a type T.

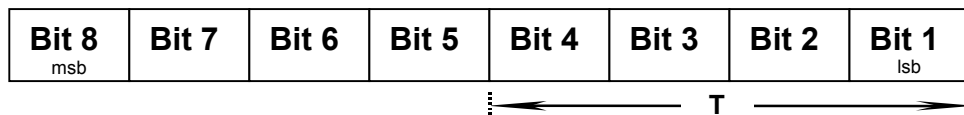

**Figure 15 — Coding of TA<sub>2</sub>**

NOTE An interface device supporting the three values  $F$ ,  $D$  and T referenced by TA<sub>2</sub> should initiate the transmission protocol T with  $F$  and  $D$ . Otherwise, it should perform either a warm reset (bit 8 set to 0) or a deactivation (bit 8 set to 1).

The first TA for T=15 encodes the clock stop indicator (X) and the class indicator (Y). The default values are X = “clock stop not supported” and Y = “only class A supported”. For the use of clock stop, see 6.3.2. For the use of the classes of operating conditions, see 6.2.1 and 6.2.4.

- According to Table 9, bits 8 and 7 indicate whether the card supports clock stop ( $\neq 00$ ) or not ( $= 00$ ) and, when supported, which state is preferred on the electrical circuit CLK when the clock is stopped.

Table 9 — X

Bits 8 and 7	00	01	10	11
X	Clock stop not supported	State L	State H	No preference

- According to Table 10, bits 6 to 1 indicate the classes of operating conditions accepted by the card. Each bit represents a class: bit 1 for class A, bit 2 for class B and bit 3 for class C (see 5.1.3).

Table 10 — Y

Bits 6 to 1	00 0001	00 0010	00 0100	00 0011	00 0110	00 0111	Any other value
Y	A only	B only	C only	A and B	B and C	A, B and C	RFU

The first TB for T=15 indicates the use of SPU by the card (see 5.2.4). The default value is “SPU not used”.

Coded over bits 7 to 1, the use is either standard (bit 8 set to 0), or proprietary (bit 8 set to 1). The value '00' indicates that the card does not use SPU. ISO/IEC JTC 1/SC 17 reserves for future use any other value where bit 8 is set to 0.

## 9 Protocol and parameters selection

### 9.1 PPS exchange

The PPS exchange shall start as specified in 6.3.1. The character frame shall be as specified in 7.1 and 7.2, using the coding convention fixed by TS (see 8.1), with *GT* as specified in 8.3 and *WT* = 9 600 etu. The error signal and character repetition according to 7.3 is mandatory for the cards offering T=0; it is optional for the interface devices and for other cards.

Only the interface device is permitted to start the PPS exchange.

- The interface device shall transmit a PPS request to the card.
- If the card receives an erroneous PPS request, it shall not transmit any response.
- If the card receives a correct PPS request, it shall transmit a PPS response, if implemented, or *WT* will be exceeded.
- In the following three cases: overrun of *WT*, erroneous PPS response, unsuccessful PPS exchange, the interface device shall perform a deactivation.

### 9.2 PPS request and response

The PPS request and PPS response each consist of an initial byte PPSS, followed by a format byte PPS0, three optional parameter bytes PPS<sub>1</sub>, PPS<sub>2</sub>, PPS<sub>3</sub> and a check byte PCK as the last byte.

- PPSS identifies the PPS request or response and is set to 'FF'.
- In PPS0, each bit 5, 6 or 7 set to 1 indicates the presence of an optional byte PPS<sub>1</sub>, PPS<sub>2</sub>, PPS<sub>3</sub>, respectively. Bits 4 to 1 encode a type T to propose a transmission protocol. Bit 8 is reserved for future use and shall be set to 0.

- PPS<sub>1</sub> allows the interface device to propose values of  $F$  and  $D$  to the card. Encoded in the same way as in TA<sub>1</sub>, these values shall be from  $F_d$  to  $F_i$  and from  $D_d$  to  $D_i$  respectively. If an interface device does not transmit PPS<sub>1</sub>, it proposes to continue with  $F_d$  and  $D_d$ . The card either acknowledges both values by echoing PPS<sub>1</sub> (then these values become  $F_n$  and  $D_n$ ) or does not transmit PPS<sub>1</sub> to continue with  $F_d$  and  $D_d$  (then  $F_n = 372$  and  $D_n = 1$ ).
- PPS<sub>2</sub> allows the interface device to propose a use of SPU. PPS<sub>2</sub> shall be encoded in the same way as the first TB for T=15. If an interface device does not transmit PPS<sub>2</sub>, or if it transmits PPS<sub>2</sub> = '00', it proposes not to use SPU.
- PPS<sub>3</sub> is reserved for future use.
- Exclusive-oring all the bytes PPSS to PCK inclusive shall give '00'. Any other value is invalid.

Figure 16 shows the structure of the PPS request and response.

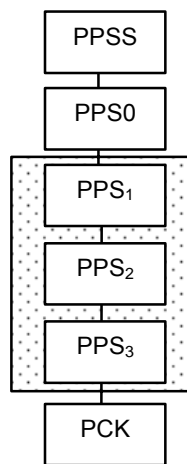

**Figure 16 — Structure of PPS request and response**

By definition, the PPS request or response is completed 12 etu after the leading edge of the character conveying PCK.

### 9.3 Successful PPS exchange

A PPS exchange is successful if and only if the PPS response is in the following conditions with respect to the PPS request.

- Bits 1 to 4 of PPS0\_Response shall be identical to bits 1 to 4 of PPS0\_Request.
- Bit 5 of PPS0\_Response shall be either identical to bit 5 of PPS0\_Request or set to 0.
  - If bit 5 is set to 1, PPS<sub>1</sub>\_Response shall be identical to PPS<sub>1</sub>\_Request.
  - If bit 5 is set to 0, PPS<sub>1</sub>\_Response shall be absent, meaning that  $F_d$  and  $D_d$  shall be used.
- Bit 6 of PPS0\_Response shall be either identical to bit 6 of PPS0\_Request or set to 0.
  - If bit 6 is set to 1, PPS<sub>2</sub>\_Response shall be identical to PPS<sub>2</sub>\_Request.
  - If bit 6 is set to 0, PPS<sub>2</sub>\_Response shall be absent, meaning that the card does not use SPU.
- Bit 7 of PPS0\_Response shall be either identical to bit 7 of PPS0\_Request or set to 0.
  - If bit 7 is set to 1, PPS<sub>3</sub>\_Response shall be identical to PPS<sub>3</sub>\_Request.
  - If bit 7 is set to 0, PPS<sub>3</sub>\_Response shall be absent (the exact meaning is reserved for future use).

In the most common case, the PPS response is identical to the PPS request.

## 10 Protocol T=0, half-duplex transmission of characters

### 10.1 Scope

This clause defines the structure and processing of commands in a half-duplex transmission of characters. The interface device initiates these commands. This clause covers transmission control.

### 10.2 Character level

The transmission protocol shall start as specified in 6.3.1. The character frame shall be as specified in 7.1 and 7.2, using the coding convention fixed by TS (see 8.1), with  $GT$  as specified in 8.3. Both the card and the interface device shall use the error signal and character repetition according to 7.3.

When using  $D = 64$ , the interface device shall ensure a delay of at least 16 etu between the leading edge of the last received character and the leading edge of the character transmitted for initiating a command.

If present in the Answer-to-Reset, the interface byte  $TC_2$  encodes the waiting time integer  $WI$  over the eight bits, except the value '00' reserved for future use. If  $TC_2$  is absent, then the default value is  $WI = 10$ .

The "waiting time" (see 7.2) shall be:  $WT = WI \times 960 \times \frac{Fi}{f}$

### 10.3 Structure and processing of commands

#### 10.3.1 Principles

The interface device initiates every command by transmitting a five-byte header that tells the card what to do. The command processing continues with the transfer of a variable number of data bytes in one direction under the control of procedure bytes transmitted by the card.

It is assumed that the card and the interface device know a priori the direction of transfer, in order to distinguish

- commands for incoming data transfer where the data bytes enter the card while processing, and
- commands for outgoing data transfer where the data bytes leave the card while processing.

#### 10.3.2 Command header

The header consists of five bytes denoted CLA, INS, P1, P2 and P3. The values of CLA, INS, P1 and P2 shall be as specified in ISO/IEC 7816-4.

- CLA denotes a class of commands. The value 'FF' is invalid (reserved for PPSS, see 6.3.1 and 9.2).

NOTE ISO/IEC 7816-4 enforces 'FF' as invalid value of CLA.

- INS denotes an instruction code. The values '6X' and '9X' are invalid.

NOTE ISO/IEC 7816-4 enforces '6X' and '9X' as invalid values of INS.

- P1 P2 denotes an instruction parameter, e.g., a reference completing the instruction code.

- P3 encodes the number of data bytes denoted  $D_1$  to  $D_n$  to be transferred during the command.

- In an outgoing data transfer command, P3='00' introduces a 256-byte data transfer from the card.
- In an incoming data transfer command, P3='00' introduces no data transfer.

### 10.3.3 Procedure bytes

After transmitting the header as a string of five characters, the interface device shall wait for a character conveying a procedure byte. There are three types of procedure bytes, see Table 11.

- If the value is '60', it is a NULL byte. It requests no action on data transfer. The interface device shall wait for a character conveying a procedure byte.
- If the value is '6X' or '9X', except for '60', it is a SW1 byte. It requests no action on data transfer. The interface device shall wait for a character conveying a SW2 byte. There is no restriction on SW2 value.  
NOTE ISO/IEC 7816-4 enforces '60' as invalid value of SW1, as well as any value different from '9X' and '6X'.
- If the value is the value of INS, apart from the values '6X' and '9X', it is an ACK byte. All remaining data bytes if any bytes remain, denoted  $D_i$  to  $D_n$ , shall be transferred subsequently. Then the interface device shall wait for a character conveying a procedure byte.
- If the value is the exclusive-or of 'FF' with the value of INS, apart from the values '6X' and '9X', it is an ACK byte. Only the next data byte if it exists, denoted  $D_i$ , shall be transferred. Then the interface device shall wait for a character conveying a procedure byte.
- Any other value is invalid.

**Table 11 — Procedure bytes**

Byte	Value	Action on data transfer	Then reception of
NULL	'60'	No action	A procedure byte
SW1	'6X' (≠'60'), '9X'	No action	A SW2 byte
ACK	INS	All remaining data bytes (if any bytes remain)	A procedure byte
	$\text{INS} \oplus \text{'FF'}$	The next data byte (if it exists)	A procedure byte

The first two editions of ISO/IEC 7816-3 specified the use of two values of ACK (namely, the exclusive-or of the value of INS with '01' and 'FE') to control the deprecated use of contact C6 (see 5.1.1). These two values are deprecated.

At each procedure byte, the card can proceed with the command by NULL or ACK, or finish the command by SW1 SW2, or show its disapproval by becoming unresponsive (*WT* will be exceeded).

### 10.3.4 Status bytes

The status bytes SW1 SW2 indicate the card status at the end of the command. Their values shall be as specified in ISO/IEC 7816-4.

NOTE ISO/IEC 7816-4 enforces the meaning of six values of SW1 SW2, specified for T=0 by the previous editions (ISO/IEC 7816-3:1989 and 1997).

- '9000' command normally completed
- '6E00' CLA not supported
- '6D00' CLA supported, but INS not programmed or invalid
- '6B00' CLA INS supported, but P1 P2 incorrect
- '6700' CLA INS P1 P2 supported, but P3 incorrect
- '6F00' command not supported and no precise diagnosis given

By definition, the command is completed 12 etu after the leading edge of the character conveying SW2.

## 11 Protocol T=1, half-duplex transmission of blocks

### 11.1 Scope and principles

This clause defines the structure and processing of commands in a half-duplex transmission of blocks. A block is a byte string conveyed in asynchronous characters. The interface device and the card may initiate these commands. This clause covers data transmission control such as flow control, block chaining and error correction.

The main characteristics of the transmission protocol are the following.

- The transmission protocol starts with a first block transmitted by the interface device; it continues with alternating the right to transmit a block.
- A block is the smallest data unit that can be exchanged. A block may be used to convey
  - application data transparent to the transmission protocol,
  - transmission control data including transmission error handling.
- The block structure allows checking the received block before processing the conveyed data.

The transmission protocol applies the principle of the OSI reference model. Three layers are defined.

- The physical layer transmits moments organized in asynchronous characters according to 11.2.
- The data link layer includes a character component and a block component.
  - The character component recognizes the beginning and the end of a block according to 11.5.
  - The block component exchanges blocks according to 11.6.
- The application layer processes commands, which involves the exchange of at least one block or chain of blocks in each direction.

### 11.2 Character frame

The transmission protocol shall start as specified in 6.3.1. The character frame shall be as specified in 7.1 and 7.2, using the coding convention fixed by TS (see 8.1). The error signal and character repetition according to 7.3 shall not be used. There are two guard times.

- Denoted *CGT*, the “character guard time” is the minimum delay between the leading edges of two consecutive characters in the same direction of transmission. If  $N = 0$  to 254,  $CGT = GT$  as specified in 8.3. If  $N = 255$ ,  $CGT = 11$  etu in both directions of transmission.
- Denoted *BGT*, the “block guard time” is the minimum delay between the leading edges of two consecutive characters in opposite directions.  $BGT = 22$  etu.

Character parity allows checking a block in addition to the error detection code (see 11.3.4 and 11.4.4).

### 11.3 Block frame

#### 11.3.1 General

As shown in Figure 17, a block consists of two or three fields.

- The prologue field consists of a node address byte, a protocol control byte and a length byte.
- The information field consists of zero to 254 bytes.
- The epilogue field consists of one or two bytes.

Prologue field (mandatory)			Information field (optional)	Epilogue field (mandatory)
NAD (1 byte)	PCB (1 byte)	LEN (1 byte)	INF (0 to 254 bytes)	LRC (1 byte) or CRC (2 bytes)

Figure 17 — Block frame

The transmission protocol defines three types of blocks.

- An information block (I-block) is used to convey information for use by the application layer. In addition, it conveys a positive or negative acknowledgment.
- A receive ready block (R-block) is used to convey a positive or negative acknowledgment. Its information field shall be absent.
- A supervisory block (S-block) is used to exchange control information between the interface device and the card. Its information field may be present depending on its controlling function.

NOTE This separation allows the design of the protocol control and the application portions of the device micro code to be relatively independent of each other.

### 11.3.2 Prologue field

#### 11.3.2.1 Node address byte

The node address byte (NAD) allows identifying the source and the intended destination of the block; it may be used to distinguish between multiple logical connections when they coexist. The value 'FF' is invalid. It is reserved for PPSS (see 6.3.1 and 9.2). Bits 1 to 3 are the source node address denoted SAD and bits 5 to 7 the destination node address denoted DAD. Bits 4 and 8 are deprecated. The card should set them to 00. The interface device shall ignore them.

NOTE The first two editions of ISO/IEC 7816-3 specified bits 4 and 8 to control the deprecated use of contact C6 (see 5.1.1).

When the addressing is not used, the values of SAD and DAD shall be set to 000. Any other value of NAD where SAD and DAD are identical is reserved for future use.

In the first block transmitted by the interface device, NAD shall set up a logical connection by associating the addresses SAD and DAD. Subsequent blocks in which NAD contains the same pair of addresses SAD and DAD are associated with the same logical connection. During information exchange, other pairs of addresses SAD and DAD may set up other logical connections.

NOTE For example, blocks transmitted by the interface device with the values  $x$  for SAD and  $y$  for DAD and blocks transmitted by the card with the values  $y$  for SAD and  $x$  for DAD belong to a logical connection denoted  $(x, y)$ , whereas blocks transmitted by the interface device with the values  $v$  for SAD and  $w$  for DAD and blocks transmitted by the card with the values  $w$  for SAD and  $v$  for DAD belong to another logical connection  $(v, w)$ .

#### 11.3.2.2 Protocol control byte

The protocol control byte (PCB) conveys information required to control transmission. PCB defines whether the block is an I-block, an R-block or an S-block.

In every I-block, bit 8 of PCB is set to 0 as shown in Figure 18.

- Bit 7 encodes the send-sequence number denoted N(S).
- Bit 6 is the more-data bit denoted M-bit.
- Bits 5 to 1 are reserved for future use and shall be set to 0.

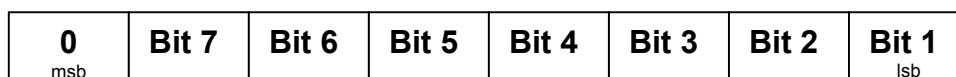

Figure 18 — Coding of I-block PCB

In every R-block, bits 8 and 7 of PCB are set to 10 as shown in Figure 19. Bits 6 to 1 are used as follows.

- 0-N(R)-0000 denotes an error-free acknowledgement.
- 0-N(R)-0001 indicates a redundancy code error or a character parity error.

- 0-N(R)-0010 indicates other errors.
- Any other value is reserved for future use.

NOTE The value N(R) states whether the R-block indicates an error or not. Bits 4 to 1 may be ignored.

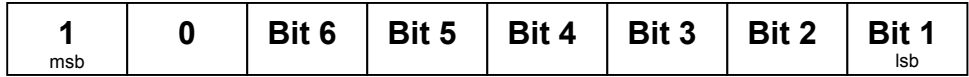

Figure 19 — Coding of R-block PCB

In every S-block, bits 8 and 7 of PCB are set to 11 as shown in Figure 20. Bits 6 to 1 are used as follows.

- 000000 indicates a RESYNCH request and 100000 a RESYNCH response.
- 000001 indicates an IFS request and 100001 an IFS response.
- 000010 indicates an ABORT request and 100010 an ABORT response.
- 000011 indicates a WTX request and 100011 a WTX response.
- 100100 is deprecated.
- Any other value is reserved for future use.

NOTE Bit 6 is the response bit.



Figure 20 — Coding of S-block PCB

**11.3.2.3 Length byte**

The length byte (LEN) encodes the number of bytes in the information field of the block (see also 11.4.2).

- The value '00' encodes zero: INF is absent.
- The values from '01' to 'FE' encode the numbers 1 to 254: INF is present.
- The value 'FF' is reserved for future use.

**11.3.3 Information field**

The use of the information field (INF) depends upon the block type.

- When present in an I-block, INF conveys application information.
- INF shall be absent in an R-block.
- When present in an S-block, INF conveys non-application information.
  - INF shall be present with a single byte in an S-block adjusting IFS and WTX.
  - INF shall be absent in an S-block managing chain abortion or resynchronization.

**11.3.4 Epilogue field**

The epilogue field conveys the error detection code of the block, either a longitudinal redundancy code (LRC), or a cyclic redundancy code (CRC).

- LRC consists of one byte. When LRC is used, exclusive-oring all the bytes of the block from NAD to LRC inclusive shall give '00'. Any other value is invalid.
- CRC consists of two bytes. For its value, see ISO/IEC 13239<sup>[4]</sup>.



## 11.4 Protocol parameters

### 11.4.1 Specific interface bytes for T=1

Three specific interface bytes are specified: the first TA for T=1, the first TB for T=1 and the first TC for T=1 (see 8.2.3). They are used to set up protocol parameters at non-default values.

### 11.4.2 Information field sizes

IFSC is the maximum size of information field of blocks that can be received by the card. If present, the first TA for T=1 sets up the initial value of IFSC. The default value is 32.

IFSD is the maximum size of information field of blocks that can be received by the interface device. The initial value of IFSD is 32.

At the start of the transmission protocol, IFSC and IFSD are initialized. During the transmission protocol, IFSC and IFSD may be adjusted by S(IFS request) and S(IFS response) where INF consists of one byte named IFS. In any case, the first TA for T=1 and each byte IFS shall be encoded as follows.

- The values '00' and 'FF' are reserved for future use.
- The values '01' to 'FE' encode the numbers 1 to 254.

NOTE 1 This document recommends an IFS value of at least '20'.

NOTE 2 The block size is the total number of bytes present in the prologue, information and epilogue fields. The maximum block size is set to IFS plus four or five, depending upon the size of the epilogue field.

### 11.4.3 Waiting times

By definition,  $CWT$  is the maximum delay between the leading edges of two consecutive characters in the block (see Figure 21). The minimum delay is  $CGT$  (see 11.2).

NOTE When there is a potential error in the length,  $CWT$  may be used to detect the end of a block.

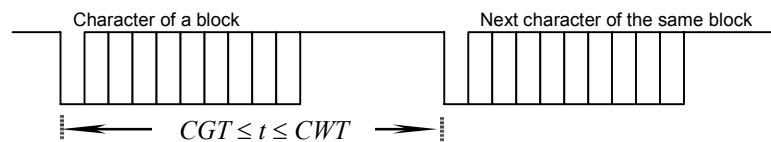

Figure 21 — Character timings within the block

Bits 4 to 1 of the first TB for T=1 encode  $CWI$  from zero to fifteen. The default value is  $CWI = 13$ .  $CWT$  is calculated from  $CWI$  by the following formula. Therefore the minimum value is  $CWT = 12$  etu.

$$CWT = (11 + 2^{CWI}) \text{ etu}$$

By definition,  $BWT$  is the maximum delay between the leading edge of the last character of the block received by the card and the leading edge of the first character of the next block transmitted by the card (see Figure 22).  $BWT$  is used to detect an unresponsive card. The minimum delay is  $BGT$  (see 11.2).

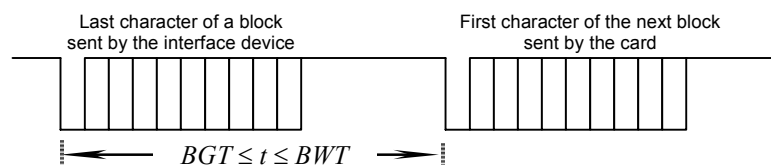

Figure 22 — Block timings

Bits 8 to 5 of the first TB for T=1 encode  $BWI$  from zero to nine. The values 'A' to 'F' are reserved for future use. The default value is  $BWI = 4$ .  $BWT$  is calculated from  $BWI$  by the following formula.

$$BWT = 11 \text{ etu} + 2^{BWI} \times 960 \times \frac{Fd}{f}$$

#### 11.4.4 Redundancy code

Bit 1 of the first TC for T=1 indicates the error detection code to be used:

- CRC if bit 1 is set to 1;
- LRC (default value) if bit 1 is set to 0.

Bits 8 to 2 of the first TC for T=1 are reserved for future use and shall be set to 0.

### 11.5 Character component operation at data link layer

At the start of the transmission protocol, the interface device has the right to transmit. Asynchronous characters are always grouped in blocks.

When either the card or the interface device has transmitted a block, it switches to reception mode. When either the card or the interface device has received a block according to the number of bytes encoded in the length byte, it assumes that it has the right to transmit.

### 11.6 Block component operation at data link layer

#### 11.6.1 Block notation

The following blocks are used in the descriptions of the transmission protocol.

I-blocks are denoted as follows.

I(N(S), M) I-block where N(S) is the send-sequence number and M is the more-data bit (see 11.6.2.2)

$N_a(S)$ ,  $N_b(S)$  send-sequence numbers of I-blocks where indices a and b distinguish sources A and B

R-blocks are denoted as follows.

R(N(R)) R-block where N(R) is the send-sequence number of the expected I-block

S-blocks are denoted as follows.

S(RESYNCH request) S-block requesting a resynchronization

S(RESYNCH response) S-block acknowledging the resynchronization

S(IFS request) S-block offering a maximum size of the information field

S(IFS response) S-block acknowledging IFS

S(ABORT request) S-block requesting a chain abortion

S(ABORT response) S-block acknowledging the chain abortion

S(WTX request) S-block requesting a waiting time extension

S(WTX response) S-block acknowledging the waiting time extension

In S(IFS...) and S(WTX...), INF is present according to rules 3 and 4 in 11.6.2.3.

#### 11.6.2 Error-free operation

##### 11.6.2.1 General procedures

At the start of the transmission protocol, the first block transmitted by the interface device to the card shall be either an I-block or an S-block.

After a block (I-, R- or S-block) has been transmitted, an acknowledgment shall be received before starting the transmission of the next block, as described hereafter.

Every I-block carries its send-sequence number N(S). The I-blocks transmitted by the interface device and those transmitted by the card are counted independently from each other. N(S) is counted modulo 2 and encoded by one bit. At the start of the transmission protocol or after resynchronization, the initial value is N(S) = 0; then the value alternates after transmitting each I-block.

Every R-block carries N(R) which is the send-sequence number N(S) of the expected I-block. In error-free operation, R-blocks are used for chaining I-blocks (see 11.6.2.2).

An I-block is acknowledged by receiving either

- an I-block where N(S) is different from N(S) of the previously received I-block, or
- an R-block where N(R) is different from N(S) of the transmitted I-block (see rule 2.2 in 11.6.2.3).

An S-block carries no send-sequence number. S(...request) carries no acknowledgment. S(...response) acknowledges S(...request).

### 11.6.2.2 Chaining

The chaining function allows the interface device or the card to transmit information (application data) longer than IFSC or IFSD. If the interface device or the card has to transmit information longer than IFSC or IFSD respectively, it should divide the information into pieces, each with length less than or equal to IFSC or IFSD, and it should transmit each piece in a block using the chaining function. Figure 23 illustrates the chaining function.

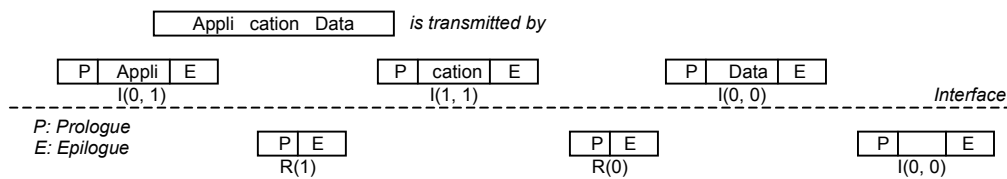

Figure 23 — Chaining function

The M-bit in PCB controls the chaining of I-blocks. The value of the M-bit indicates the state of the I-block.

- If M = 1, then the I-block is chained to the next block, which shall be an I-block.
- If M = 0, then the I-block is not chained to the next block.

If the receiver correctly receives a more-data I-block, then it shall transmit R(N(R)), where N(R) is set to N(S) of the expected I-block.

NOTE I-blocks with LEN = '00' may be used within a chain (see scenario 7 in annex A).

### 11.6.2.3 Protocol rules for error-free operation

**Rule 1** — The interface device transmits the first block, either an I-block with N(S) = 0 denoted I(0, M), or an S-block.

**Rule 2.1** — I(N<sub>a</sub>(S), 0) transmitted by A is acknowledged by I(N<sub>b</sub>(S), M) transmitted by B to transfer application data and to indicate readiness to receive the next I-block from A.

**Rule 2.2** — I(N<sub>a</sub>(S), 1) transmitted by A is acknowledged by R(N<sub>b</sub>(R)) transmitted by B [N<sub>b</sub>(R) is not set to N<sub>a</sub>(S)] to indicate that the received block was correct and the readiness to receive the next I-block from A.

NOTE Chaining is only possible in one direction at a time.

**Rule 3** — If the card requires more than *BWT* to process the previously received I-block, it transmits S(WTX request) where INF conveys one byte encoding an integer multiplier of the *BWT* value. The interface device shall acknowledge by S(WTX response) with the same INF.

The time allocated starts at the leading edge of the last character of S(WTX response).

**Rule 4** — The card transmits S(IFS request) to indicate a new IFSC it can support. The interface device shall acknowledge by S(IFS response) with the same INF. The interface device assumes the new IFSC is valid as long as no other IFSC is indicated by another S(IFS request).

The interface device transmits S(IFS request) to indicate a new IFSD it can support. The card shall acknowledge by S(IFS response) with the same INF. The card assumes the new IFSD is valid as long as no other IFSD is indicated by another S(IFS request).

For the encoding of IFSC and IFSD in INF, see 11.4.2.

**Rule 5** — Chaining is indicated by the M-bit, where I(N(S), 0) is a non-chained block or the last block of a chain. I(N(S), 1) is a part of a chain and shall be followed by at least one chained block.

R(N(R)) requests transmission of the next chained I-block I(N(S) = N(R), ...) and acknowledges the received chained I-block I(NOT N(R), 1).

### 11.6.3 Error-handling

#### 11.6.3.1 Errors detected by the receiver

The tasks of the block layer are to transmit blocks, to detect transmission and sequence errors, to handle such errors and to resynchronize the transmission protocol. Therefore the block component of the data link layer should be able to handle the following errors.

— *BWT* time-out — The card did not transmit any character within the specified delay.

— Reception of an invalid block — Examples are

- character parity error(s),
- redundancy code error,
- invalid PCB (due to unknown encoding),
- invalid LEN (transmission error or incompatibility with the block type or with IFSC or IFSD),
- loss of synchronization because the block size and the number encoded by LEN are inconsistent,
- failure to receive the relevant S(... response) after having transmitted S(... request).

Resynchronization of the transmission protocol may be attempted at three consecutive levels. If one level is unsuccessful, then the next level is tried.

— For the interface device, the three levels are

- retransmission of blocks,
- use of S(RESYNCH request),
- warm reset or deactivation.

— For the card, the three levels are

- retransmission of blocks,
- use of S(RESYNCH response),
- without action by the interface device, the card becomes unresponsive.

### 11.6.3.2 Protocol rules for error-handling

**Rule 6** — S(RESYNCH request) may be transmitted only by the interface device to reach resynchronization and to initiate resetting the communication parameters of the transmission protocol to its initial values.

**Rule 6.1** — If the receiver detects a loss of synchronization, it gets back the right to transmit after a silence on the electrical circuit I/O greater than the larger of *CWT* or *BGT*.

**Rule 6.2** — S(RESYNCH request) shall be responded to by S(RESYNCH response) from the card.

**Rule 6.3** — After the interface device has received S(RESYNCH response), the transmission protocol is initiated.

**Rule 6.4** — After the interface device has failed a maximum of three times in succession to reach the intended resynchronization by transmitting S(RESYNCH request), it performs either a warm reset or a deactivation.

**Rule 6.5** — When S(RESYNCH request) is received, the previously transmitted block is assumed not to have been received.

**Rule 7.1** — When an I-block was transmitted and an invalid block is received or a *BWT* time-out (with the interface device) occurs, an R-block is transmitted, which requests with its  $N(R)$  for the expected I-block with  $N(S) = N(R)$ .

**Rule 7.2** — When an R-block was transmitted and an invalid block is received or a *BWT* time-out (with the interface device) occurs, this R-block is retransmitted.

**Rule 7.3** — When S(... request) was transmitted and the received response is not S(... response) or a *BWT* time-out occurs (only with the interface device), S(... request) is retransmitted.

When S(... response) was transmitted and an invalid block is received or a *BWT* time-out occurs (only with the interface device), an R-block is transmitted.

**Rule 7.4.1** — After failing to receive an error-free block at the start of the transmission protocol, the interface device makes a maximum of two further attempts in succession before performing either a warm reset or a deactivation.

**Rule 7.4.2** — During the transmission protocol, if the interface device fails to receive an error-free block, it makes a maximum of two further attempts in succession before transmitting S(RESYNCH request).

**Rule 7.4.3** — If the card fails to receive an error-free block after a second attempt in succession, it remains in reception mode.

**Rule 7.5** — On receiving an invalid first block, the card reacts by transmitting R(0).

**Rule 7.6** — If the first block transmitted by the interface device is not responded to within *BWT*, the interface device transmits R(0).

**Rule 8** — When the card transmits S(IFS request) and receives an invalid block, it retransmits a maximum of one more S(IFS request) in order to elicit an S(IFS response). After the second failure, it remains in reception mode.

**Rule 9** — The abortion of a chain can be initiated by either the transmitter or receiver of a chain transmitting S(ABORT request) which shall be answered by S(ABORT response), after what an R-block may be transmitted depending on whether it is necessary to give back the right to transmit.

NOTE Abortion of chaining may be due to physical errors in the card, such as memory error.

## 12 Transmission of command-response pairs

### 12.1 Application protocol data units

#### 12.1.1 Command-response pairs

An application protocol data unit is either a command APDU or a response APDU. A step in application protocol consists of transmitting a command APDU, processing it in the receiving entity and returning the response APDU. This pair of APDUs is called a command-response pair.

Illustrated by Figure 24, each command APDU defined in this document consists of

- a mandatory header of four bytes denoted CLA INS P1 P2,
- a conditional body of variable length.

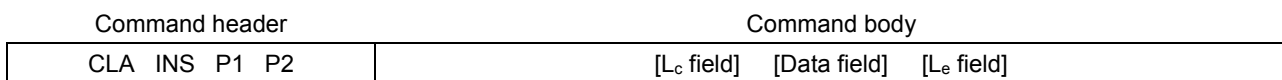

**Figure 24 — Command APDU structure**

Illustrated by Figure 25, each response APDU defined in this document consists of

- a conditional body of variable length,
- a mandatory trailer of two bytes denoted SW1 SW2 and encoding the status of the receiving entity after processing the command.

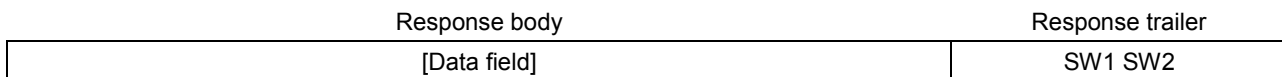

**Figure 25 — Response APDU structure**

The values of the command header and the response trailer shall be as specified in ISO/IEC 7816-4. If the process is aborted, then the card may become unresponsive. However if a response APDU occurs, then the response body shall be absent and SW1 SW2 shall indicate an error.

#### 12.1.2 Data fields within command-response pairs

Each command-response pair may carry a command data field and/or a response data field.

- $N_c$  denotes the number of bytes in the command data field. If  $N_c \neq 0$ , then the L<sub>c</sub> field is present for encoding  $N_c$  and the command data field consists of the subsequent  $N_c$  bytes. If  $N_c = 0$ , then both the L<sub>c</sub> field and the command data field are absent.
- $N_e$  denotes the maximum number of bytes expected in the response data field. If  $N_e \neq 0$ , then the L<sub>e</sub> field is present for encoding  $N_e$ . If  $N_e = 0$ , then the L<sub>e</sub> field is absent.
- $N_r$  denotes the number of bytes in the response data field.  $N_r$  shall be from zero to  $N_e$ . If  $N_r = 0$ , then the response data field is absent.

In case 1,  $N_c = N_r = 0$ . The command APDU consists of the header; the L<sub>c</sub> field, the command data field and the L<sub>e</sub> field are absent. The response APDU consists of the trailer; the response data field is absent.

In case 2,  $N_c = 0$  and  $N_r \neq 0$ . The command APDU consists of the header and the L<sub>e</sub> field; the L<sub>c</sub> field and the command data field are absent. The response APDU consists of the response data field and the trailer.

In case 3,  $N_c \neq 0$  and  $N_r = 0$ . The command APDU consists of the header, the L<sub>c</sub> field and the command data field; the L<sub>e</sub> field is absent. The response APDU consists of the trailer; the response data field is absent.

In case 4,  $N_c \neq 0$  and  $N_r \neq 0$ . The command APDU consists of the header, the L<sub>c</sub> field, the command data field and the L<sub>e</sub> field. The response APDU consists of the response data field and the trailer.

Table 12 summarizes the four possible cases of command-response pairs.

**Table 12 — Data fields within command-response pairs**

<b>Case 1</b>	No command data field	No response data field
<b>Case 2</b>	No command data field	Response data field
<b>Case 3</b>	Command data field	No response data field
<b>Case 4</b>	Command data field	Response data field

Figure 26 shows the four structures of command APDUs according to the previous four cases.

- A command APDU of case 1 consists of a header.
- A command APDU of case 2 consists of a header and a  $L_e$  field.
- A command APDU of case 3 consists of a header, a  $L_c$  field and a data field.
- A command APDU of case 4 consists of a header, a  $L_c$  field, a data field and a  $L_e$  field.

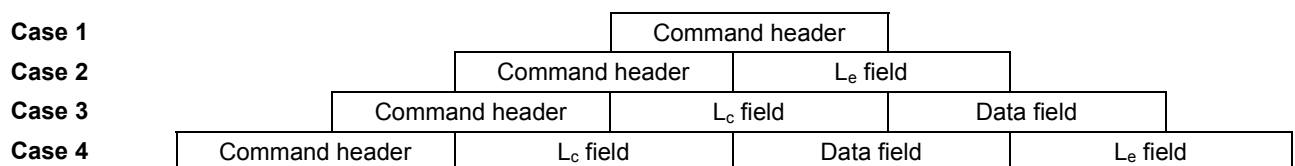
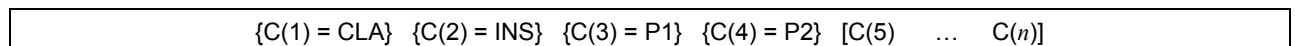

**Figure 26 — The four structures of command APDUs**

Consequently, within any command-response pair, the absence of  $L_e$  field in the command APDU is the standard way for receiving no response data field in the response APDU.

### 12.1.3 Decoding conventions for command APDUs

Figure 27 illustrates a command APDU as a string of  $n$  bytes. The header consists of the first four bytes, namely CLA INS P1 P2. The body consists of all the subsequent bytes, namely  $C(5)$  to  $C(n)$  if any.



**Figure 27 — Command APDU as a byte string**

- In case 1, the body is absent. Consequently,  $n = 4$ .
- In case 2, the  $L_e$  field is either short (case 2S) or extended (case 2E).
  - Case 2S** — The short  $L_e$  field consists of  $C(5)$  encoding  $N_e$  from 1 to 256 ('00' means the maximum, 256). Consequently,  $n = 5$ .
  - Case 2E** — The extended  $L_e$  field consists of  $C(5) = '00'$  and  $C(6) C(7)$  encoding  $N_e$  from 1 to 65 536 ('0000' means the maximum, 65 536). Consequently,  $n = 7$ .
- In case 3, the  $L_c$  field is either short (case 3S) or extended (case 3E).
  - Case 3S** — The short  $L_c$  field consists of  $C(5) \neq '00'$ , encoding  $N_c$  from 1 to 255. The data field consists of  $C(6)$  to  $C(5+N_c)$ . Consequently,  $n = 5 + (C(5))$ .
  - Case 3E** — The extended  $L_c$  field consists of  $C(5) = '00'$  and  $C(6) C(7) \neq '0000'$ , encoding  $N_c$  from 1 to 65 535. The data field consists of  $C(8)$  to  $C(7+N_c)$ . Consequently,  $n = 7 + (C(6) C(7))$ .
- In case 4, both length fields are either short (case 4S) or extended (case 4E).
  - Case 4S** — The short  $L_c$  field consists of  $C(5) \neq '00'$ , encoding  $N_c$  from 1 to 255. The data field consists of  $C(6)$  to  $C(5+N_c)$ . The short  $L_e$  field consists of  $C(6+N_c)$  encoding  $N_e$  from 1 to 256 ('00' means the maximum, 256). Consequently,  $n = 6 + (C(5))$ .
  - Case 4E** — The extended  $L_c$  field consists of  $C(5) = '00'$  and  $C(6) C(7) \neq '0000'$ , encoding  $N_c$  from 1 to 65 535. The data field consists of  $C(8)$  to  $C(7+N_c)$ . The extended  $L_e$  field consists of  $C(8+N_c) C(9+N_c)$  encoding  $N_e$  from 1 to 65 536 ('0000' means the maximum, 65 536). Consequently,  $n = 9 + (C(6) C(7))$ .

Table 13 summarizes the command APDU decoding according to the seven cases.

**Table 13 — Command APDU decoding**

Condition on C(5)	Condition on C(6) C(7)	Number of bytes	Case
Absent	Absent	4	<b>1</b>
Present, any value	Absent	5	<b>2S</b>
Present, ≠ '00'	C(6) and possibly C(7) present	5 + (C(5))	<b>3S</b>
Present, ≠ '00'	Present, any value	6 + (C(5))	<b>4S</b>
Present, = '00'	Present, any value	7	<b>2E</b>
Present, = '00'	Present, ≠ '0000'	7 + (C(6) C(7))	<b>3E</b>
Present, = '00'	Present, ≠ '0000'	9 + (C(6) C(7))	<b>4E</b>
Any other command APDU is invalid.			

Cases 1, 2S, 3S and 4S apply to all cards. Cases 2E, 3E and 4E also apply to cards explicitly stating their capability of handling extended length fields (card capabilities shall be as specified in ISO/IEC 7816-4).

## 12.2 Command-response pair transmission by T=0

### 12.2.1 General

This clause defines the mapping of application protocol data units (APDU) into transmission protocol data units (TPDU) by T=0 using GET RESPONSE and ENVELOPE commands (see ISO/IEC 7816-4) as needed. For example, a command-response pair of case 4S is processed as two consecutive pairs of command and response TPDU: the second command TPDU is a GET RESPONSE command. Table 14 summarizes certain response trailer values (see ISO/IEC 7816-4) used hereafter for the mapping.

**Table 14 — Response trailer values used hereafter for the mapping by protocol T=0**

SW1 SW2	Meaning
'9000'	Process completed normally. In cases 1, 2 and 3, no further action. In case 4, after receiving $N_c$ command data bytes, the card shall be ready to receive at least one GET RESPONSE command for transferring at most $N_e$ response data bytes.
'61XY'	Process completed normally (SW2 encodes $N_x$ , i.e., the number of extra data bytes still available). In cases 1 and 3, the card should not use such a value. In cases 2 and 4, for transferring response data bytes, the card shall be ready to receive a GET RESPONSE command with P3 set to the minimum of $N_x$ and $N_e$ .
'62XY' '63XY'	Process completed with warning. In case 1, no further action. In cases 2, 3 and 4, if the warning indication appears before transferring all the command and/or response data bytes, then either the process continues (e.g., GET RESPONSE command for transferring response data bytes), or the warning indication induces another command (e.g., '6202' to '6280', GET DATA command for transferring a card-originated byte string, see ISO/IEC 7816-4). Hence, the card should not use such a value until the last response TPDU (see text below).
'6700'	Process aborted due to a wrong length. No further action.
'6CXY'	Process aborted due to a wrong $L_e$ field (SW2 encodes $N_a$ , i.e., the exact number of available data bytes). In cases 1 and 3, the card should not use such a value. In cases 2 and 4, the card shall be ready to receive the same command with P3 = SW2.
'6D00'	Process aborted due to an invalid or not supported instruction code. No further action.

Consecutive interindustry command-response pairs may be chained: CLA = 0xx1 xxxx in the first command APDU up to the penultimate one and CLA = 0xx0 xxxx in the last one; the other six bits remain constant within the chain (chaining shall be as specified in ISO/IEC 7816-4).

- When an interindustry command-response pair within a chain (CLA = 0xx1 xxxx) is processed as two or more consecutive pairs of command and response TPDU, then in the command TPDU, all the CLAs shall be set to the same value, i.e., 0xx1 xxxx.



- When the last interindustry command-response pair of a chain (bit 5 of CLA switched from 1 to 0, i.e., CLA = 0xx0 xxxx) is processed as two or more consecutive pairs of command and response TPDU, then the chain really ends up at the last pair of command and response TPDU. Consequently, for providing the right indication in the command TPDU, the first CLA up to the penultimate one shall be set to 0xx1 xxxx and the last CLA to 0xx0 xxxx.

In cases 4S, 2E, 3E and 4E, if the card supports command chaining (see ISO/IEC 7816-4), then for any interindustry command-response pair with CLA = 0xx0 xxxx, whatever bit 5 is in the previous CLA, the above rule shall apply where appropriate. Hence command chaining allows the card to know whether a command TPDU is the last one or not, so as not to use warning indications until the last response TPDU.

### 12.2.2 Case 1

The command APDU is mapped onto the command TPDU with P3 = '00'.

Command APDU	CLA INS P1 P2
Command TPDU	CLA INS P1 P2 {P3 = '00'}

The response TPDU is mapped onto the response APDU without any change.

Response TPDU	SW1 SW2
Response APDU	SW1 SW2

### 12.2.3 Case 2S

The short  $L_e$  field consists of one byte: C(5) with any value for encoding  $N_e$  from 1 to 256 ('00' means the maximum, 256). The command APDU is mapped onto the command TPDU without any change.

Command APDU	CLA INS P1 P2	{ $L_e$ field = C(5)}
Command TPDU	CLA INS P1 P2	{P3 = C(5)}

The response TPDU is mapped onto the response APDU according to the acceptance of  $N_e$  and according to the processing of the command.

#### Case 2S.1 — Process completed; $N_e$ accepted

The response TPDU is mapped onto the response APDU without any change.

Response TPDU	$N_e$ data bytes	SW1 SW2
Response APDU	$N_e$ data bytes	SW1 SW2

#### Case 2S.2 — Process aborted; $N_e$ definitely not accepted

The card does not accept  $N_e$  and does not support the service of providing data if the length is wrong. The response TPDU from the card indicates that the process is aborted due to a wrong length: SW1 SW2 = '6700'. The response TPDU is mapped onto the response APDU without any change.

Response TPDU	{SW1 SW2 = '6700'}
Response APDU	{SW1 SW2 = '6700'}

**Case 2S.3 — Process aborted;  $N_e$  not accepted,  $N_a$  indicated**

The card does not accept  $N_e$  and the response TPDU from the card indicates that the process is aborted: SW1 = '6C' (wrong length) and SW2 with any value for encoding  $N_a$  from 1 to 256 ('00' means 256), namely, the exact number of available data bytes.

Response TPDU	{SW1 = '6C'} SW2
---------------	------------------

The card shall be ready to receive the same command TPDU with P3 = SW2.

Command TPDU	CLA INS P1 P2 {P3 = SW2}
--------------	--------------------------

The response TPDU consists of  $N_a$  data bytes followed by SW1 SW2.

Response TPDU	$N_a$ data bytes	SW1 SW2
---------------	------------------	---------

— If  $N_a \leq N_e$ , then the response TPDU is mapped onto the response APDU without any change.

Response APDU	$N_a (\leq N_e)$ data bytes	SW1 SW2
---------------	-----------------------------	---------

— If  $N_a > N_e$ , then the response TPDU is mapped onto the response APDU by keeping only the first  $N_e$  bytes of the response APDU and the two status bytes SW1 SW2.

Response APDU	$N_e (< N_a)$ data bytes	SW1 SW2
---------------	--------------------------	---------

**Case 2S.4 — SW1 SW2 = '9XYZ', except for '9000'**

The response TPDU is mapped onto the response APDU without any change.

**12.2.4 Case 3S**

The short  $L_c$  field consists of one byte: C(5)  $\neq$  '00' for encoding  $N_c$  from 1 to 255. The command APDU is mapped onto the command TPDU without any change.

Command APDU	CLA INS P1 P2	{ $L_c$ field = C(5)}	$N_c$ data bytes
--------------	---------------	-----------------------	------------------

Command TPDU	CLA INS P1 P2 {P3 = C(5)}	$N_c$ data bytes
--------------	---------------------------	------------------

The response TPDU is mapped onto the response APDU without any change.

Response TPDU	SW1 SW2
---------------	---------

Response APDU	SW1 SW2
---------------	---------

**12.2.5 Case 4S**

The short  $L_c$  field consists of one byte: C(5)  $\neq$  '00' for encoding  $N_c$  from 1 to 255. The short  $L_e$  field consists of one byte: C( $n$ ) with any value for encoding  $N_e$  from 1 to 256 ('00' means the maximum, 256). The command APDU is mapped onto the command TPDU by cutting off the  $L_e$  field, i.e., C( $n$ ).

Command APDU	CLA INS P1 P2	{ $L_c$ field = C(5)}	$N_c$ data bytes	{ $L_e$ field = C( $n$ )}
--------------	---------------	-----------------------	------------------	---------------------------

Command TPDU	CLA INS P1 P2 {P3 = C(5)}	$N_c$ data bytes
--------------	---------------------------	------------------

**Case 4S.1 — Process aborted**

The first response TPDU from the card indicates that the process is aborted: SW1 = '6X', except for '61', '62' and '63'. The response TPDU is mapped onto the response APDU without any change.

Response TPDU	{SW1 = '6X' except for '61', '62' and '63'} SW2
Response APDU	{SW1 = '6X' except for '61', '62' and '63'} SW2

**Case 4S.2 — Process completed**

The first response TPDU from the card indicates that the process is completed: SW1 SW2 = '9000'. The card shall be ready to receive a GET RESPONSE command TPDU with P3 = C(n).

Command TPDU	CLA {INS = GET RESPONSE} P1 P2 {P3 = C(n)}
--------------	--

Depending on the second response TPDU from the card, the process shall continue according to cases 2S.1, 2S.2, 2S.3 and 2S.4 above.

**Case 4S.3 — Process completed with information added**

The first response TPDU from the card indicates that the process is completed and the card gives information: SW1 = '61' and SW2 with any value for encoding  $N_x$  from 1 to 256 ('00' means 256), namely, the number of extra data bytes still available. The card shall be ready to receive a GET RESPONSE command TPDU with P3 set to the minimum of  $N_x$  and  $N_e$ .

Command TPDU	CLA {INS = GET RESPONSE} P1 P2 {P3 = min( $N_e$ , $N_x$ )}
--------------	--

The second response TPDU is mapped onto the response APDU without any change.

Response TPDU	P3 data bytes	SW1 SW2
Response APDU	P3 data bytes	SW1 SW2

**Case 4S.4 — SW1 SW2 = either '62XY' or '63XY' or '9XYZ', except for '9000'**

The response TPDU is mapped onto the response APDU without any change.

NOTE In case 4S, the use of '62XY' and '63XY' is not recommended in the first response TPDU.

**12.2.6 Case 2E**

The extended  $L_e$  field consists of three bytes: C(5) C(6) C(7); C(5) = '00' and C(6) C(7) has any value for encoding  $N_e$  from 1 to 65 536 ('0000' means the maximum, 65 536).

Command APDU	CLA INS P1 P2	{ $L_e$ field = C(5) C(6) C(7)}
--------------	---------------	---------------------------------

**Case 2E.1 —  $N_e \leq 256$ , C(5) = '00', C(6) C(7) from '0001' to '0100'**

As  $N_e$  is from 1 to 256, the command APDU shall be mapped onto the command TPDU with P3 = C(7). The process shall continue according to case 2S.

Command TPDU	CLA INS P1 P2 {P3 = C(7)}
--------------	---------------------------

**Case 2E.2 —  $N_e > 256$ , C(5) = '00', C(6) C(7) = either '0000' or from '0101' to 'FFFF'**

As  $N_e > 256$ , the command APDU shall be mapped onto the command TPDU with P3 = '00'.

Command TPDU	CLA INS P1 P2 {P3 = '00'}
--------------	---------------------------

- a) If the first response TPDU from the card indicates that the process is aborted due to a wrong length (SW1 SW2 = '6700'), then the response TPDU shall be mapped onto the response APDU without any change.

Response TPDU	{SW1 SW2 = '6700'}
Response APDU	{SW1 SW2 = '6700'}

- b) If the first response TPDU from the card indicates that the process is aborted due to a wrong length and the card gives information: SW1 = '6C' and SW2 with any value for encoding  $N_a$  from 1 to 256 ('00' means 256), namely, the exact number of available data bytes, then the process shall be completed as described in case 2S.3.

- c) If the first response TPDU is 256 data bytes followed by SW1 SW2 = '9000', this means that the card has no more than 256 data bytes, and/or does not support the GET RESPONSE command. The response TPDU shall then be mapped onto the response APDU without any change.

Response TPDU	256 data bytes	{SW1 SW2 = '9000'}
Response APDU	256 data bytes	{SW1 SW2 = '9000'}

- d) If the first or subsequent response TPDU from the card is SW1 = '61', then SW2 with any value encodes  $N_x$  from 1 to 256 ('00' means 256), namely, the number of extra data bytes still available. The number of remaining data bytes to be retrieved from the card is  $N_m = N_e$  minus the number of data bytes received in the previous response TPDU.

- If  $N_m = 0$ , then the response APDU shall be the concatenation of the data bytes of all received response TPDU's together with the trailer of the last received response TPDU.
- If  $N_m > 0$ , then the card shall be ready receive a GET RESPONSE command TPDU with P3 set to the minimum of  $N_x$  and  $N_m$ . The corresponding response TPDU from the card shall be processed
  - according to case d), if SW1 = '61',
  - as above when  $N_m$  is zero, if SW1 SW2 = '9000'.

**12.2.7 Case 3E**

The extended  $L_c$  field consists of three bytes: C(5) C(6) C(7); C(5) = '00' and C(6) C(7)  $\neq$  '0000' for encoding  $N_c$  from 1 to 65 535.

Command APDU	CLA INS P1 P2	{ $L_c$ field = C(5) C(6) C(7)}	$N_c$ data bytes
--------------	---------------	---------------------------------	------------------

**Case 3E.1 —  $N_c$  from 1 to 255, C(5) C(6) = '0000', C(7)  $\neq$  '00'**

As  $N_c$  is from 1 to 255, the command APDU is mapped onto the command TPDU with P3 = C(7).

Command TPDU	CLA INS P1 P2 {P3 = C(7)}	$N_c$ data bytes
--------------	---------------------------	------------------

The response TPDU is mapped onto the response APDU without any change.

Response TPDU	SW1 SW2
Response APDU	SW1 SW2

**Case 3E.2 —  $N_c > 255$ , C(5) = '00', C(6)  $\neq$  '00', C(7) any value**

The command APDU shall be split into consecutive segments of less than 256 bytes transmitted into the data bytes of consecutive ENVELOPE command TPDU's. The absence of data bytes means "end of data string".

Command TPDU	CLA {INS = ENVELOPE} P1 P2 P3	P3 bytes
--------------	-------------------------------	----------

- If the first response TPDU from the card indicates that the card does not support the ENVELOPE command (SW1 SW2 = '6D00'), the TPDU shall be mapped onto the response APDU without any change.

Response TPDU	{SW1 SW2 = '6D00'}
Response APDU	{SW1 SW2 = '6D00'}

- If the first response TPDU from the card indicates that the card does support the ENVELOPE command (SW1 SW2 = '9000'), then the card shall be ready to receive further ENVELOPE commands as needed.

Response TPDU	{SW1 SW2 = '9000'}
Command TPDU	CLA {INS = ENVELOPE} P1 P2 P3   P3 bytes

- The response TPDU corresponding to the last ENVELOPE command is mapped onto the response APDU without any change.

Response TPDU	SW1 SW2
Response APDU	SW1 SW2

**12.2.8 Case 4E**

The extended  $L_c$  field consists of three bytes:  $C(5) C(6) C(7)$ ;  $C(5) = '00'$  and  $C(6) C(7) \neq '0000'$  for encoding  $N_c$  from 1 to 65 535. The extended  $L_e$  field consists of two bytes:  $C(n-1) C(n)$  with any value for encoding  $N_e$  from 1 to 65 536 ('0000' means the maximum, 65 536).

Command APDU	CLA INS P1 P2   { $L_c$ field = $C(5) C(6) C(7)$ }   $N_c$ data bytes   { $L_e$ field = $C(n-1) C(n)$ }
--------------	---

**Case 4E.1 —  $N_c < 256$ ,  $C(5) C(6) = '0000'$ ,  $C(7) \neq '00'$**

As  $N_c$  is from 1 to 255, the command APDU is mapped onto the command TPDU with  $P3 = C(7)$  and by appending the  $N_c$  data bytes. The  $L_e$  field, i.e.,  $C(n-1) C(n)$ , is cut off.

Command TPDU	CLA INS P1 P2 { $P3 = C(7)$ }   $N_c$ data bytes
--------------	--

- a) If SW1 = '6X' except for '61', '62' or '63' in the first response TPDU from the card, then the response TPDU is mapped onto the response APDU without any change.

Response TPDU	{SW1 = '6X' except for '61', '62' or '63'} SW2
Response APDU	{SW1 = '6X' except for '61', '62' or '63'} SW2

- b) If SW1 SW2 = '9000' in the first response TPDU from the card, then
  - If  $N_e \leq 256$ , i.e.,  $C(n-1) C(n)$  from '0001' to '0100', then the card shall be ready to receive a GET RESPONSE command TPDU with  $P3 = C(n)$ . The subsequent process shall be according to cases 2S.1, 2S.2, 2S.3 and 2S.4 above.
  - If  $N_e > 256$ , i.e.,  $C(n-1) C(n) =$  either '0000' or  $> '0100'$ , then the card shall be ready to receive a GET RESPONSE command TPDU with  $P3 = '00'$ . The subsequent process shall be according to case 2E.2 above.
- c) If SW1 = '61' in the first response TPDU from the card, then the process shall continue according to case 2E.2 d) above.
- d) If SW1 SW2 = '62XY' or '63XY' or '9XYZ', except for '9000', in the first response TPDU from the card, then the response TPDU is mapped onto the response APDU without any change.

NOTE In case 4E, the use of '62XY' and '63XY' is not recommended until the last response TPDU.

**Case 4E.2 —  $N_c > 255$ , C(5) = '00', C(6) ≠ '00', C(7) any value**

As  $N_c \geq 256$ , the process shall continue according to case 3E.2 described above, until the command APDU has been completely transmitted to the card. It shall then continue as described above in case 4E.1 a), b), c) and d).

**12.3 Command-response pair transmission by T=1**

**12.3.1 General**

This clause defines the mapping of application protocol data units (APDU) into information fields of transmission protocol data units (TPDU) by T=1.

**12.3.2 Case 1**

The command APDU is mapped onto the information field of an I-block without any change.

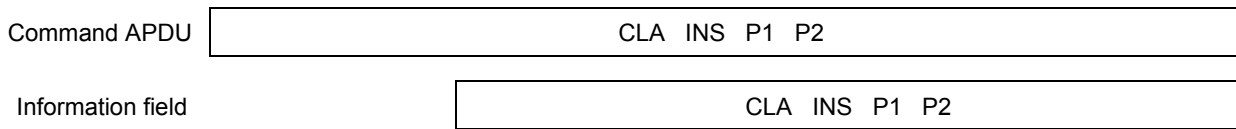

The information field of the I-block in response is mapped onto the response APDU without any change.

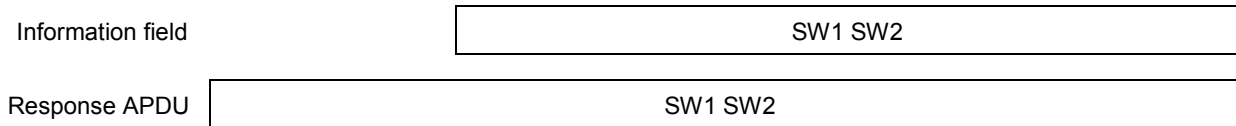

**12.3.3 Cases 2S and 2E**

The command APDU is mapped onto the information field of an I-block without any change.

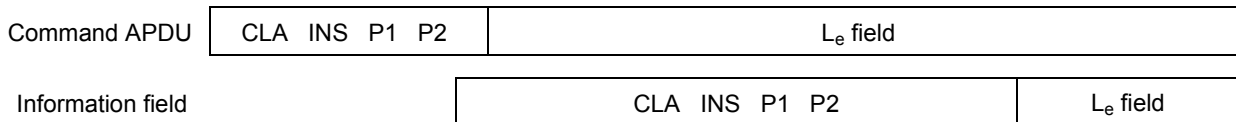

The response APDU consists of either

- the information field of the I-block in response, or
- the concatenation of the information fields of successive I-blocks in response. These blocks shall be chained.

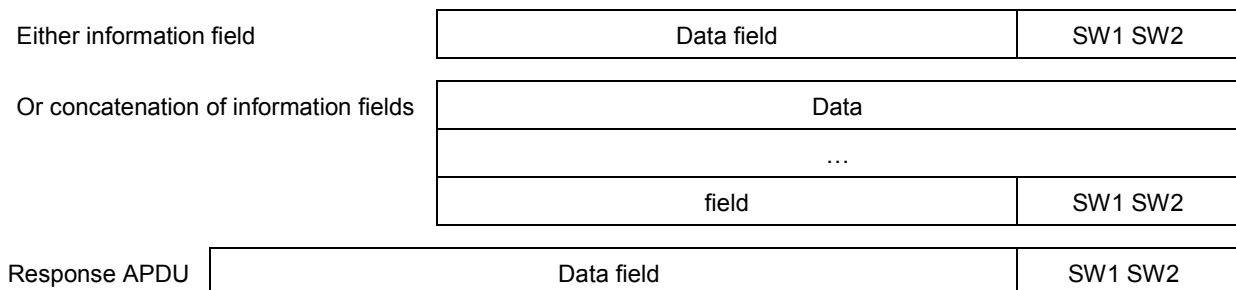

**12.3.4 Cases 3S and 3E**

The command APDU is mapped without any change onto either

- the information field of one I-block, or
- the concatenation of the information fields of successive I-blocks. These blocks shall be chained.

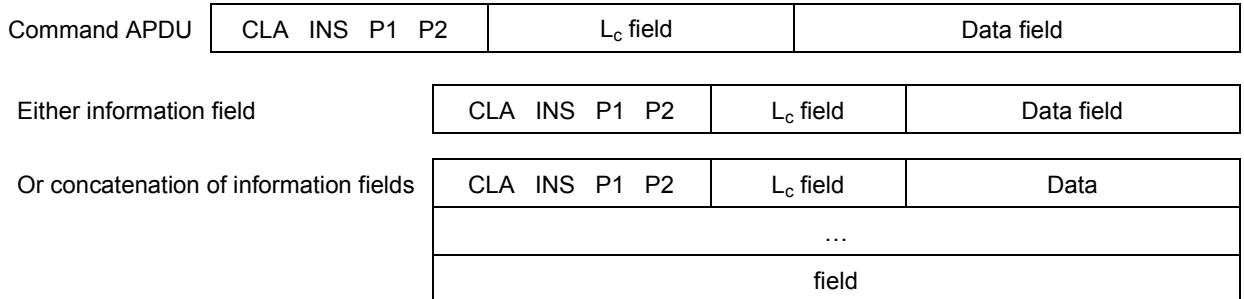

The information field of the I-block in response is mapped onto the response APDU without any change.

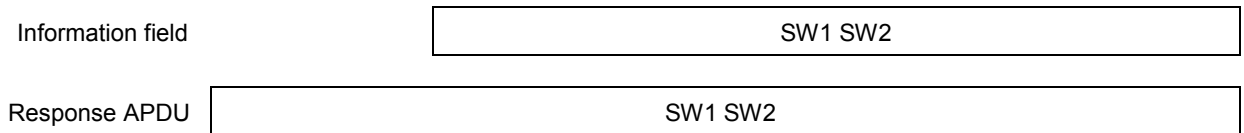

**12.3.5 Cases 4S and 4E**

The command APDU is mapped without any change onto either

- the information field of one I-block, or
- the concatenation of the information fields of successive I-blocks. These blocks shall be chained.

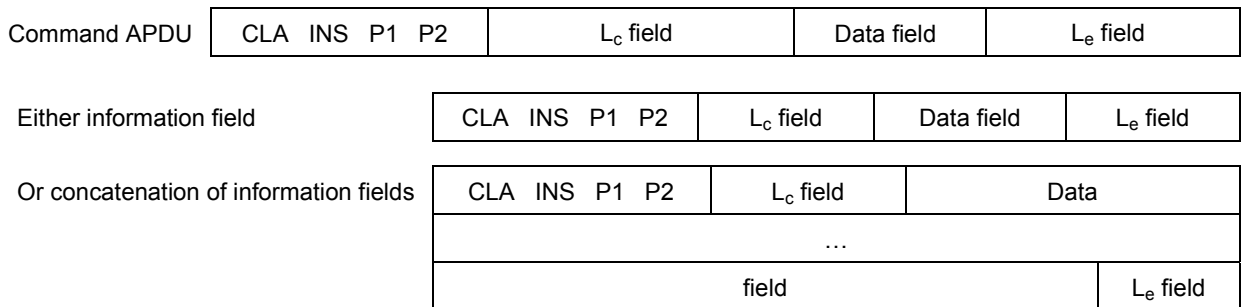

The response APDU consists of either

- the information field of the I-block in response, or
- the concatenation of the information fields of successive I-blocks in response. These blocks shall be chained.

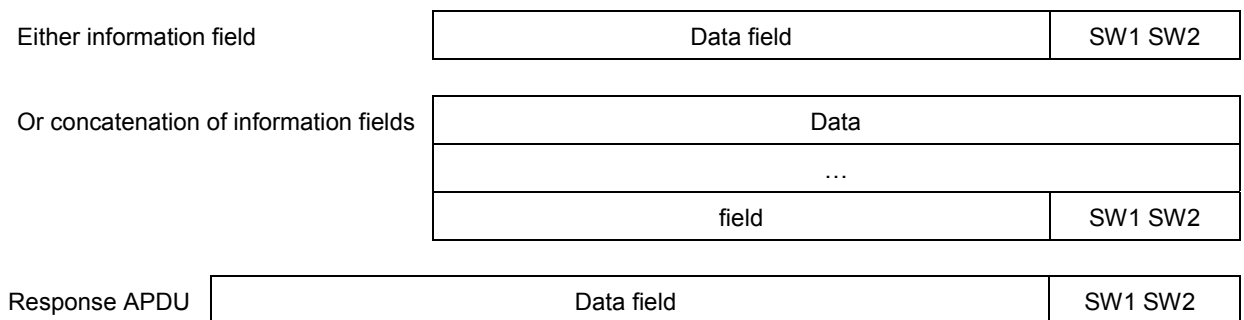

## Annex A (informative)

### Scenarios for T=1

#### A.1 Notation

For the purposes of this annex, the following notation applies in addition to the notation introduced in 11.6.1.

Any block	→	correctly received block
Any block	↔	erroneously received block (see 11.6.3.1)

#### A.2 Error-free operation (according to the rules in 11.6.2.3)

##### A.2.1 Exchange of I-blocks

Scenario 1 — (rules 1 and 2.1)

	Interface device		Card
1.1	I(0, 0)	→	
1.2		←	I(0,0)
1.3	I(1, 0)	→	
1.4		←	I(1, 0)

##### A.2.2 Waiting time extension

Scenario 2 — (rule 3) — The card requests for a waiting time extension.

	Interface device		Card
2.1	I(0, 0)	→	
2.2		←	S(WTX request)
2.3	S(WTX response)	→	
2.4		←	I(0, 0)

##### A.2.3 IFS adjustment

Scenario 3 — (rule 4) — The card initiates an IFS adjustment.

	Interface device		Card
3.1	I(0, 0)	→	
3.2		←	S(IFS request)
3.3	S(IFS response)	→	
3.4		←	I(0, 0)

Scenario 4 — (rule 4) — The interface device initiates an IFS adjustment.

	Interface device		Card
4.1	I(0, 0)	→	
4.2		←	I(0, 0)
4.3	S(IFS request)	→	
4.4		←	S(IFS response)
4.5	I(1, 0)	→	
4.6		←	I(1, 0)



### A.2.4 Chaining function

Scenario 5 — (rules 2.2 and 5) — The interface device transmits a chain.

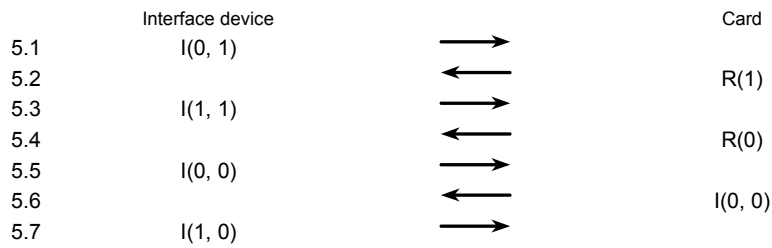

Scenario 6 — (rules 2.2 and 5) — The card transmits a chain.

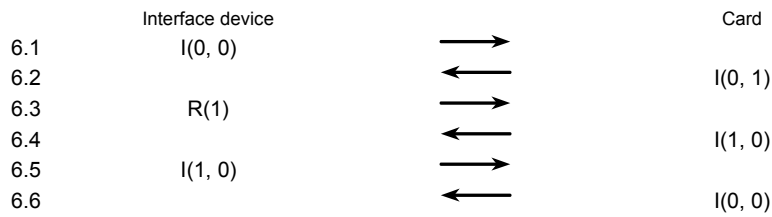

Scenario 7 — (last note of 11.6.2.2) — The card uses the M-bit to force an acknowledgment for a transmitted I-block.

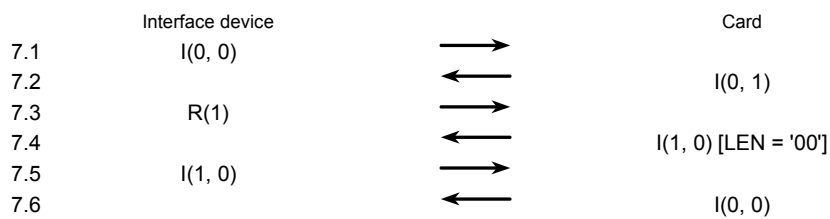

### A.3 Error handling (according to the rules in 11.6.3.2)

#### A.3.1 Exchange of I-blocks

Scenario 8 — (rule 7.5) — At the start of the transmission protocol.

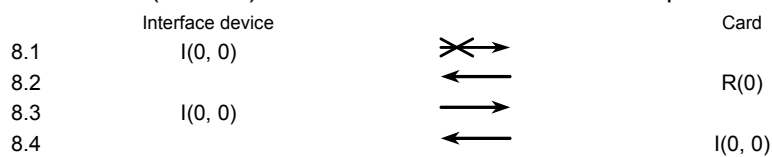

Scenario 9 — (rules 7.1 and 7.6)

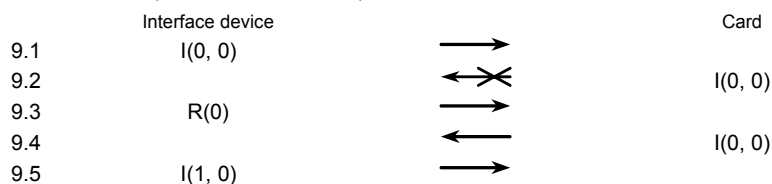

Scenario 10 — (rules 7.1, 7.5 and 7.6)

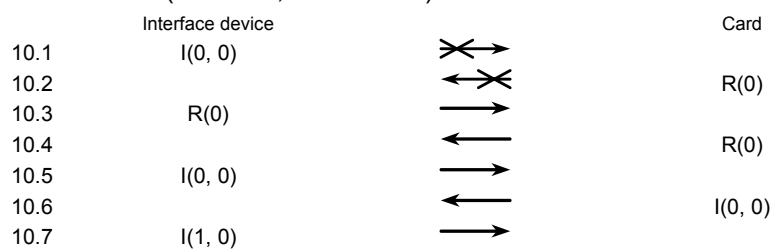

Scenario 11 — (rules 7.1 and 7.6)

	Interface device		Card
11.1	I(0, 0)	→	
11.2		← <del>X</del>	I(0, 0)
11.3	R(0)	<del>X</del> →	
11.4		←	R(1)
11.5	R(0)	→	
11.6		←	I(0, 0)
11.7	I(1, 0)	→	

Scenario 12 — (rules 7.1, 7.2 and 7.6)

	Interface device		Card
12.1	I(0, 0)	→	
12.2		← <del>X</del>	I(0, 0)
12.3	R(0)	<del>X</del> →	
12.4		← <del>X</del>	R(1)
12.5	R(0)	→	
12.6		←	I(0, 0)
12.7	I(1, 0)	→	

Scenario 13 — (rules 7.1, 7.2 and 7.6)

	Interface device		Card
13.1	I(0, 0)	→	
13.2		← <del>X</del>	I(0, 0)
13.3	R(0)	<del>X</del> →	
13.4		← <del>X</del>	R(1)
13.5	R(0)	<del>X</del> →	
13.6		←	R(1)
13.7	R(0)	→	
13.8		←	I(0, 0)
13.9	I(1, 0)	→	

A.3.2 Waiting time extension

Scenario 14 — (rule 7.3) — The card requests for a waiting time extension.

	Interface device		Card
14.1	I(0, 0)	→	
14.2		← <del>X</del>	S(WTX request)
14.3	R(0)	→	
14.4		←	S(WTX request)
14.5	S(WTX response)	→	
14.6		←	I(0, 0)
14.7	I(1, 0)	→	

Scenario 15 — (rule 7.3) — The card requests for a waiting time extension.

	Interface device		Card
15.1	I(0, 0)	→	
15.2		← <del>X</del>	S(WTX request)
15.3	R(0)	<del>X</del> →	
15.4		←	S(WTX request)
15.5	S(WTX response)	→	
15.6		←	I(0, 0)
15.7	I(1, 0)	→	

**A.3.3 IFS adjustment**

Scenario 16 — (rule 7.3) — The card requests for an IFS adjustment.

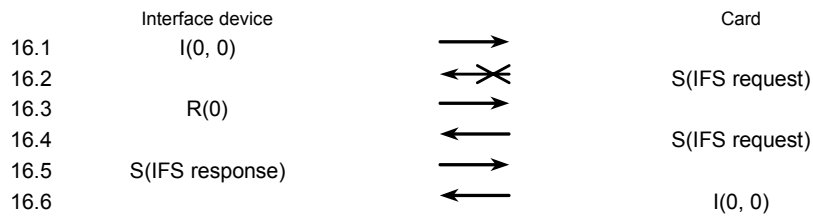

Scenario 17 — (rule 7.3) — The card requests for an IFS adjustment.

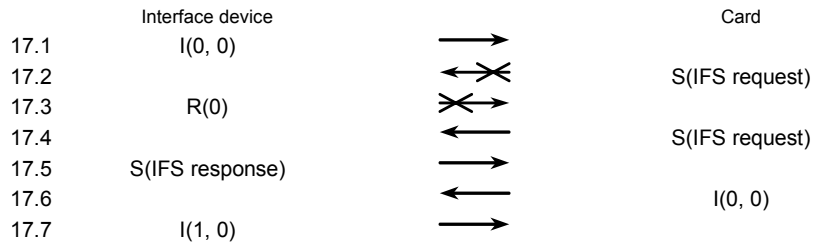

Scenario 18 — (rule 7.3) — The card requests for an IFS adjustment.

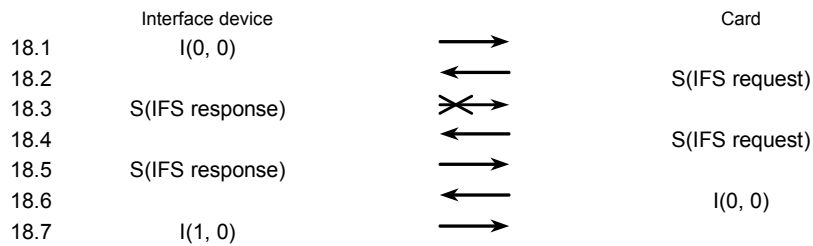

Scenario 19 — (rule 7.3) — The card requests for an IFS adjustment.

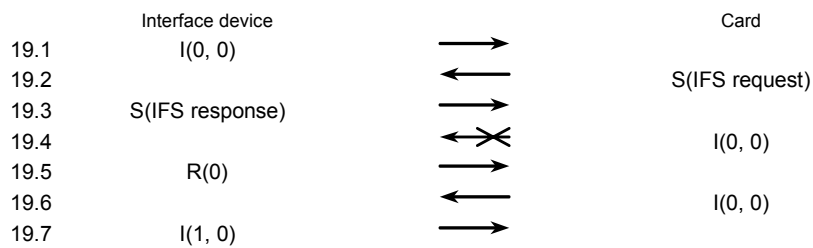

Scenario 20 — (rule 7.3) — The card requests for an IFS adjustment.

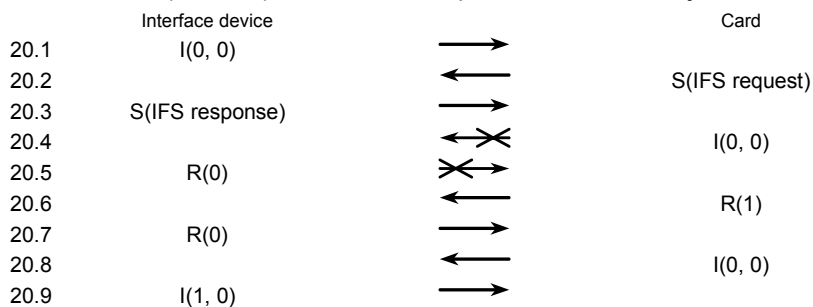

**A.3.4 Chaining function**

**A.3.4.1 The interface device transmits a chain**

**Scenario 21 — (rule 7.1)**

	Interface device		Card
21.1	I(0, 1)	→	
21.2		← <del>→</del>	R(1)
21.3	R(0)	→	
21.4		←	R(1)
21.5	I(1, 1)	→	
21.6		←	R(0)
21.7	I(0, 0)	→	
21.8		←	I(0, 0)
21.9	I(1, 0)	→	

**Scenario 22 — (rule 7.1)**

	Interface device		Card
22.1	I(0, 1)	→	
22.2		← <del>→</del>	R(1)
22.3	R(0)	<del>→</del>	
22.4		←	R(1)
22.5	I(1, 1)	→	
22.6		←	R(0)
22.7	I(0, 0)	→	
22.8		←	I(0, 0)
22.9	I(1, 0)	→	

**A.3.4.2 The cards transmits a chain**

**Scenario 23 — (rule 7.1)**

	Interface device		Card
23.1	I(0, 0)	→	
23.2		←	I(0, 1)
23.3	R(1)	<del>→</del>	
23.4		←	R(1)
23.5	R(1)	→	
23.6		←	I(1, 0)
23.7	I(1, 0)	→	
23.8		←	I(0, 0)

**Scenario 24 — (rule 7.1)**

	Interface device		Card
24.1	I(0, 0)	→	
24.2		←	I(0, 1)
24.3	R(1)	<del>→</del>	
24.4		← <del>→</del>	R(1)
24.5	R(1)	→	
24.6		←	I(1, 0)
24.7	I(1, 0)	→	
24.8		←	I(0, 0)

**A.3.4.3 Chain transmitter initiates chain abortion**

Scenario 25 — (rule 9) — The interface device initiates a chain abortion.

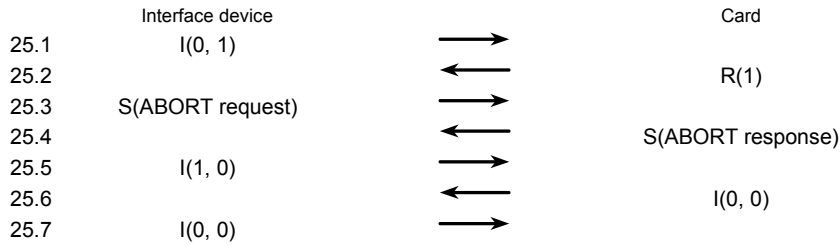

Scenario 26 — (rule 9) — The card initiates a chain abortion.



**A.3.4.4 Chain receiver initiates chain abortion**

Scenario 27 — (rule 9) — The card initiates a chain abortion.



Scenario 28 — (rule 9) — The interface device initiates a chain abortion.

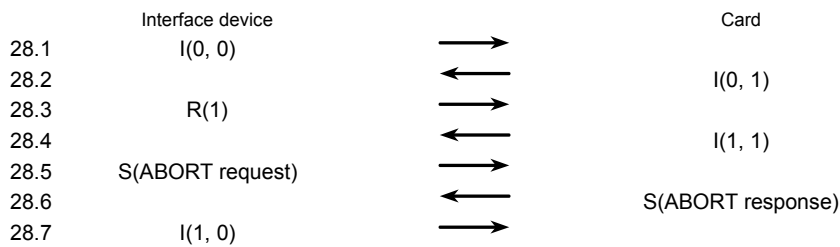

**A.3.5 Resynchronization**

Scenario 29 — (rule 6.2)

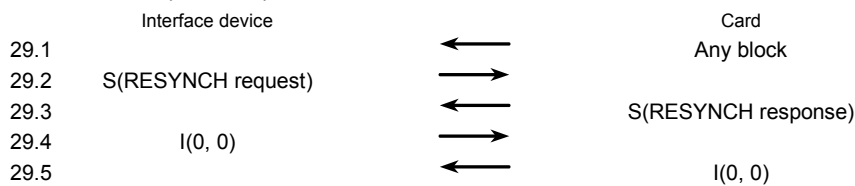

Scenario 30 — (rules 6.2 and 7.3)

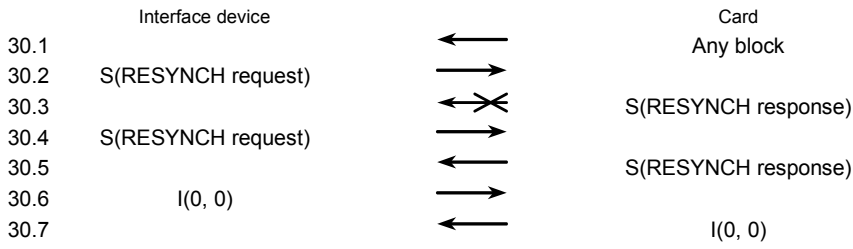

Scenario 31 — (rules 6.2, 7.1 and 7.3)

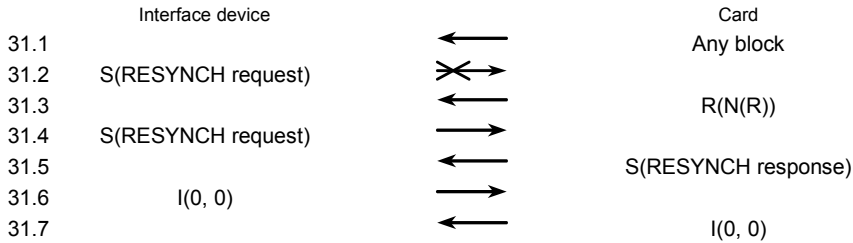

Scenario 32 —

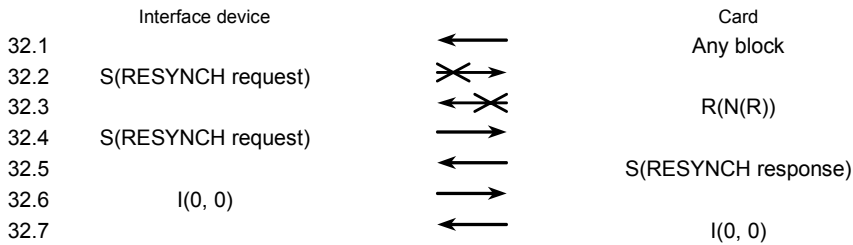

Scenario 33 — (rules 7.1 and 7.4.1) — At the start of the transmission protocol.

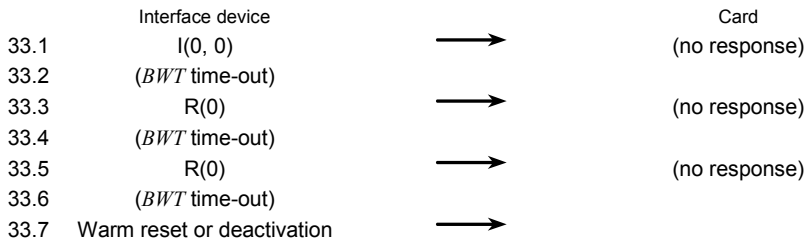

Scenario 34 — (rules 7.1, 7.4.2 and 7.4.3) — During the transmission protocol.

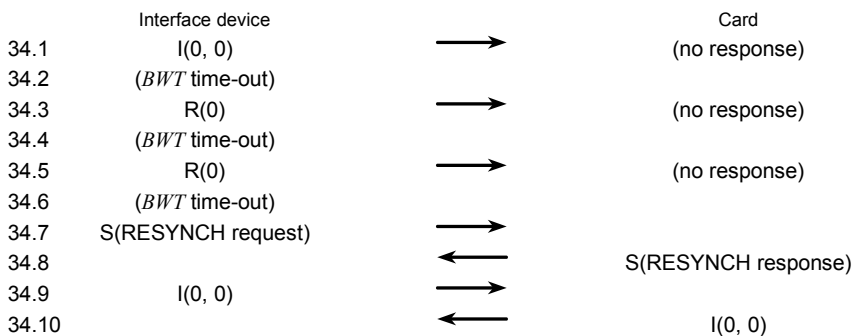

Scenario 35 — (rules 6.4, 7.1, 7.4.2 and 7.4.3) — During the transmission protocol.

	Interface device		Card
35.1	I(0, 0)	→	(no response)
35.2	( <i>BWT</i> time-out)		
35.3	R(0)	→	(no response)
35.4	( <i>BWT</i> time-out)		
35.5	R(0)	→	(no response)
35.6	( <i>BWT</i> time-out)		
35.7	S(RESYNCH request)	→	(no response)
35.8	( <i>BWT</i> time-out)		
35.9	S(RESYNCH request)	→	(no response)
35.10	( <i>BWT</i> time-out)		
35.11	S(RESYNCH request)	→	(no response)
35.12	( <i>BWT</i> time-out)		
35.13	Warm reset or deactivation	→	

## Bibliography

- [1] ISO 31 (all parts), *Quantities and units*<sup>1)</sup>
- [2] ISO/IEC 7810:2003, *Identification cards — Physical characteristics*
- [3] ISO/IEC 10536 (all parts), *Identification cards — Contactless integrated circuit(s) cards — Close-coupled cards*
- [4] ISO/IEC 13239:2002, *Information technology — Telecommunications and information exchange between systems — High-level data link control (HDLC) procedures*
- [5] ISO/IEC 14443 (all parts), *Identification cards — Contactless integrated circuit(s) cards — Proximity cards*
- [6] ISO/IEC 15693 (all parts), *Identification cards — Contactless integrated circuit(s) cards — Vicinity cards*

---

1) Published as a compilation in ISO Standards Handbook, *Quantities and units*.





