

M32

GSM / GPRS Wireless Module

DATASHEET

Rev. 0.4

19/May/ 2003

BenQ

COPYRIGHT BENQ Corporation

This document contains proprietary technical information which is the property of BenQ Corporation and is issued in strict confidential and shall not be disclosed to others parties in whole or in parts without written permission of BenQ Corporation

The documents contain information on a product, which is under development and is issued for customer evaluation purposes only.

BENQ may make changes to product specifications at any time, without notice.

BenQ Corp.

Networking & Communications BG

18 JiHu Road, Nei-Hu, Taipei 114, Taiwan, R.O.C.

Tel: +886-2-2799-8800

Fax: +886-2-2799-8332

<http://www.benq.com>

HISTORY

Version	Date	Notes
VER: 0.4	19-MAY-2003	1 , 2 , 3 , 4 , 5 , 6 , 7 , 8 , 9 , 10 , 11

Notes:

- (1) Remove IO 12 (Data Carrier Detect - DCD) and IO 1 (Ring Indicate - RI) pins for GPIO reserve pins. Page 13.
- (2) Update Interface Table of Sec 3.1 . Page 11.
- (3) Update Sec. 3.3 Pin Description .- Description Table . Page12.
- (4) Update UART/RS232 table. Page 13.
- (5) Update GPIO Table . Page 13.
- (6) Update LED driver timing sequence . Page 14.
- (7) Add Acoustics Test Table. Page 15.
- (8) Update Sec 3.5 Electrical Characteristics Table. Page 17.
- (9) Add Operating Voltage/Current Characteristics Table. Page 19.
- (10) Update Audio Uplink Characteristics. Page 19.
- (11) Update Sec. 3.6 Physical Package. Page 20.

1. INTRODUCTION	5
1.1. DESCRIPTION.....	5
1.2. APPLICATION DEVICE.....	5
2. FEATURES	6
2.1. GENERAL CHARACTERISTICS.....	6
2.2. VOICE/DATA SERVICE.....	8
TELE SERVICE.....	8
SHORT MESSAGE SERVICE.....	8
FAX SERVICE.....	8
CIRCUIT SWITCH.....	8
PACKET SWITCH.....	8
2.3. SUPPLEMENTARY SERVICE.....	9
NUMBER IDENTIFICATION.....	9
CALL OFFERING.....	9
CALL COMPLETION.....	9
MULTI-PARTY.....	9
CALL-BARRING.....	9
2.4. RF FUNCTIONALITIES.....	10
MAXIMUM TX POWER.....	10
PARAMETRIC PERFORMANCE.....	10
SENSITIVITY.....	10
RADIO FREQUENCY.....	10
3. HARDWARE DESCRIPTION	11
3.1. INTERFACE.....	11
3.2. FUNCTIONAL DIAGRAM.....	11
3.3. PIN DESCRIPTION.....	12
DESCRIPTION TABLE.....	12
UART/RS232.....	13
UART 2.....	13
BU.....	13
GPIO.....	13
LED DRIVER.....	14
SIM FUNCTION.....	14
VBAT.....	14
AUDIO FUNCTION.....	14
JTAG.....	15

BGND	15
ANTENNA.....	15
INTERRUPT.....	15
POWER ON	15
ACOUSTIC TEST (DAI INTERFACE)	15
3.4. M32 TERMINAL DEFINITION	16
3.5. ELECTRICAL CHARACTERISTICS.....	17
OPERATING VOLTAGE/CURRENT CHARACTERISTICS	19
AUDIO UPLINK CHARACTERISTICS	19
AUDIO DOWNLINK CHARACTERISTICS.....	19
GLOBAL CHARACTERISTICS	19
3.6. PHYSICAL PACKAGE.....	20
4. SOFTWARE CHARACTERISTICS.....	22
4.1. INTRODUCTION	22
4.2. SOFTWARE ARCHITECTURE	22
4.3. SOFTWARE ARCHITECTURE OF PDA/WIRELESS PSTN	22
4.4. SOFTWARE ARCHITECTURE OF NOTEBOOK	23

1. INTRODUCTION

1.1. DESCRIPTION

Overview

The document describes all the functions, features, and interfaces of the GSM/GPRS Tri band Module M32 from BenQ. The M32 can provide wireless communication solution for any product that has requirement of voice communication and data transmission through state of the art cellular technology.

In traditional mobile technology, applications were focused on voice transmission. However, due to the wide acceptance of mobile phones and popularity of internet access, the demand on data transmission based applications is growing at a fast rate.

With the BENQ M32 GSM/GPRS module, devices are enhanced in both functionality and usability based on state of the art wireless technology.

1.2. APPLICATION DEVICE

This module is designed to satisfy manufacturers, which also have a physical dimension concern of embedded GSM/GPRS features built into their products. Some main application devices of this module are:

- PDA Phone/Wireless PDA
- SMART PHONE
- Notebook
- Wireless PSTN
- Mobile Trunk
- Car Phone/Telematics
- Wireless Terminal
- Alarm/Securities System
- Remote control
- Data collection

— SIM	SIM Function
— VBAT	Battery Voltage Input
— Audio	Earphone/MIC/Hand free
— JTAG	Download/Debug interface
— Keypad Interrupt	Keypad Interrupt
— BGND	GND
— ANT	Antenna

● Software Interface:

GSM Rec. 27.07

- General
- Call Control
- Network Service
- ME Control and Status
- ME Errors
- TIA IS-101

GSM Rec. 27.05

- SMS related services
- General Configuration
- Message Configuration
- Message Receiving and Reading
- Message Sending and Writing

ITU-T Rec. V25ter

- General TA Control
- Call Control and Command Response
- Data Compression

ITU-T Rec. T.32

- Action Command
- DCE Response
- Service Command

Note: For software AT commands, please refer to the M32 AT Command List.

2.2. Voice/Data Service

Tele Service

- Speech Service With EFR (Enhance Full Rate)/FR (Full Rate)/HR (Half Rate) Codec.
- Emergency Call
- DTMF Tone Generation

Short Message Service

- SMS with MT (Mobile Terminate)/PP, MO (Mobile Originated)/PP
- Delivery Report
- Cell Broadcast

FAX Service

- Direction: MOC (Mobile originated call) & MTC (Mobile terminated call)
- Fax GSM TS 3.45 fax transparent mode
- TS 61, 62
- TIA/EIA 578, Fax class 1, Interface to PC for GSM & PSTN
- TIA/EIA 592, Fax class 2, Interface to PC for PSTN
- ITU-T V.17 (14400 bps), V29 (9600bps), V27ter (2400/4800 bps)
- Transmission speed rate: 2400, 4800, 7200, 9600bps

Circuit Switch

- Data GSM TS 4.21 transparent mode
- Data GSM TS4.22 transparent mode
- Data transmission mode: asynchronous (normal)
- Radio channel: full rate
- Transmission speed rate: 2400, 4800, 9600 bps with data compression max 14400bps
- Modem type: V.34 (28800bps)/V.32 bps(14400bps)/56k

Packet Switch

- GPRS Class B device
- Multi-Slot Transmission up to Class 10, 2 uplink slot, 4 downlink slot
- Coding Scheme CS1 – CS4 Supported

2.3. Supplementary Service

Number identification

- Calling line identification presentation (CLIP)
- Calling line identification restriction (CLIR)
- Connected line identification presentation (CoLP)
- Connected line identification restriction (CoLR)

Call Offering

- Call forwarding unconditional (CFU)
- Call forwarding on mobile subscriber busy (CFB)
- Call forwarding on no reply (CFNRy)
- Call forwarding on mobile subscriber not reachable (CFNRc)

Call Completion

- Call waiting (CW)
- Call hold (HOLD)

Multi-Party

- MPTY Supported

Call-barring

1. Barring of all outgoing calls (BAOC)
2. Barring of outgoing international calls (BOIC)
3. Barring of outgoing international calls (BOIC- xHC)
4. Barring of all incoming calls (BAIC)
5. Barring of incoming calls when roaming (BIC-Roam)

2.4. RF Functionalities

Maximum TX Power

The performance of the transmitter meets test requirement GSM 11.10 Chapter 13.

Band	Max	Min
EGSM	33 dBm \pm 2dBm	5 dBm \pm 5dBm
DCS	30 dBm \pm 2dBm	0 dBm \pm 5dBm
PCS	30 dBm \pm 2dBm	0 dBm \pm 5dBm

Parametric Performance

Tests carried out at -10°C , 25°C and 55°C for each voltage 3.6V, 3.8V and 4.0V. The Measure Peak Phase, RMS Phase, frequency error, power level, and static sensitivity meets GSM 11.10 specifications

Band	Peak Phase Error	RMS Phase Error
EGSM	$<20^{\circ}$	$<5^{\circ}$
DCS	$<20^{\circ}$	$<5^{\circ}$
PCS	$<20^{\circ}$	$<5^{\circ}$

Sensitivity

The performance of the receiver meets test requirement GSM 11.10 Chapter 14.

Band	Typical	Min
EGSM	-106 dBm	-104 dBm
DCS	-105 dBm	-103 dBm
PCS	-105 dBm	-103 dBm

Radio Frequency

Radio Frequency (900 MHz EGSM)	
Frequency Range	TX 880-915 MHz; RX 925-960 MHz
Channel Spacing	200 KHz
Number of Channels	124 Carriers x 8 (TDMA)
Modulation	GMSK
Duplex Spacing	45 MHz
Frequency Stability	+/- 0.1 ppm (Uplink TX)
Power Output	33 dBm Class 4 (2 W peak)
Output Impedance	50 Ohm
Spurious Emission	-36 dBm up to 1 GHz (< -30 dBm > 1 GHz)
Radio Frequency (1800 MHz)	
Frequency Range	TX 1710-1785 MHz; RX 1805-1880 MHz
Channel Spacing	200 KHz
Number of Channels	374 Carriers x 8 (TDMA)
Modulation	GMSK
Duplex Spacing	95 MHz
Frequency Stability	+/- 0.1 ppm (Uplink TX)
Power Output	30 dBm – 0 dBm
Output Impedance	50 Ohm
Spurious Emission	-36 dBm up to 1 GHz (< -30 dBm > 1 GHz) Compatible with phase 2 feature
Radio Frequency (1900 MHz)	
Frequency Range	TX: 1850~1910MHz; RX: 1930~1990MHz
Channel Spacing	200KHz
Number of Channels	299 Carriers x 8 (TDMA)
Modulation	GMSK
Duplex Spacing	80 MHz
Frequency Stability	+/- 0.1 ppm (Uplink TX)
Power Output	30 dBm – 0 dBm
Output Impedance	50 Ohm
Spurious Emission	-36 dBm up to 1 GHz (< -30 dBm > 1 GHz) Compatible with phase 2 feature

3. Hardware Description

3.1. INTERFACE

The function description of the M32/LCC module is illustrated as the following table. The pins of the M32 module support functions like UART, GPIO, AUDIO, SIM ... etc. These features can meet customer design requirement for PDA /Smart phone/Notebook.

Group	Pin no.	Description
UART/RS232	6	RS232 transmit Interface
UART2	2	Software Debug
BU	1	Buzzer Output
GPIO	6	General Purpose I/O
Power On	1	Power On Pin
LED Driver	1	LED Driver, Paging
SIM	4	SIM Function
VBAT	4	Battery Voltage Input
Audio	8	Earphone/MIC/Hand Free
JTAG	4	Download/Debug Interface
Keypad Interrupt	1	Keypad Interrupt
ANT	1	Antenna
BGND	9	GND

Total 48 Pins

Detailed Pin descriptions and electrical characteristics will be given in the upcoming contents.

3.2. Functional Diagram

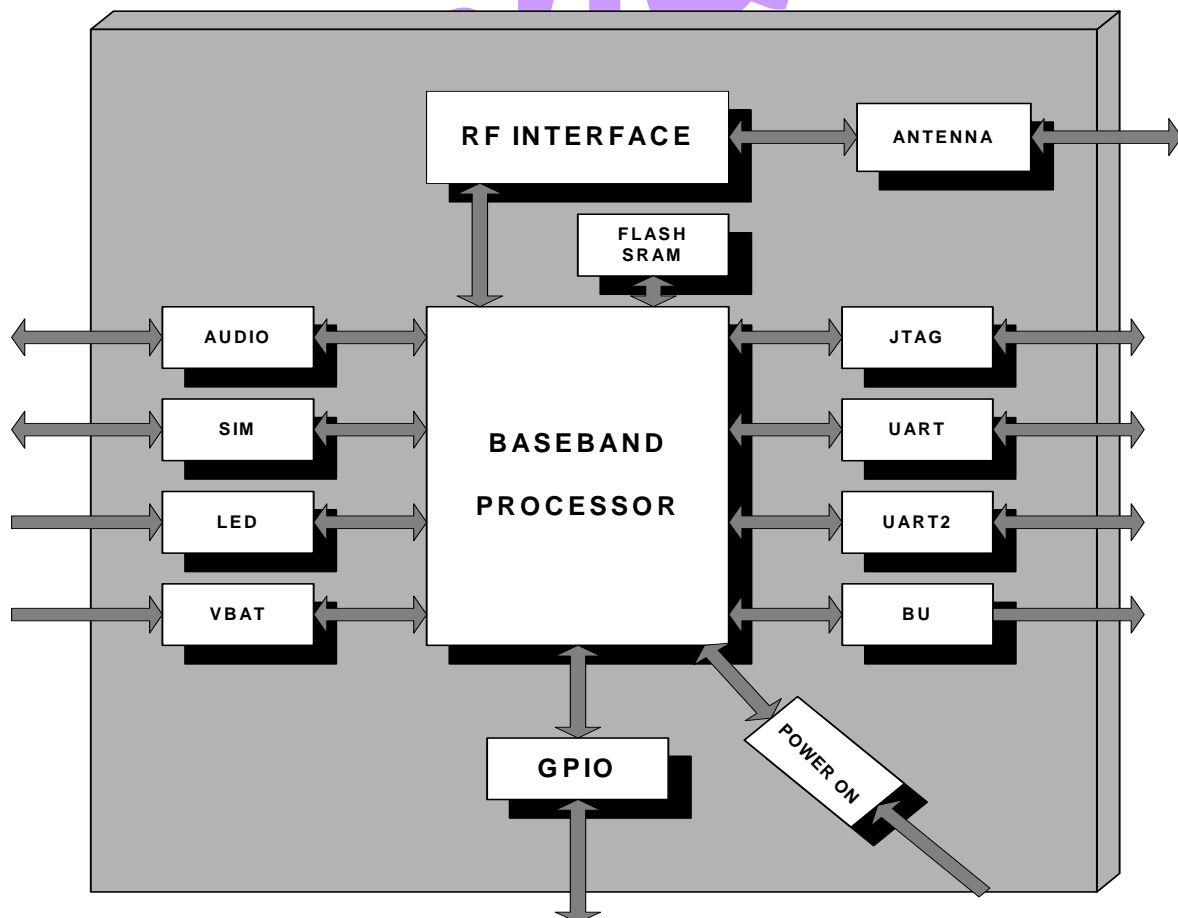

3.3. Pin Description

Description Table

No.	Pin	Description	I/O	PU	Reset	Config				
1	BGND		Ground							
2	ANT	Antenna								
3	BGND		Ground							
4	IO 10	M32 wake up External device	O		Input	Output / 0				
5	ROW4	Keypad Interrupt (Ext. device wake up of M32)	I	PU	Input	Input				
6	PWON	Power On	I	PU	Input	Input				
7	TXD2	UART2-Transmit Data	O		Output / 1	1				
8	RXD2	UART2-Receive Data	I	PU	Input	Input				
9	BU	Buzzer Output	O		0	0				
10	IO 12	GPIO 12	O		Input	Output / 0				
11	BGND		Ground							
12	BGND		Ground							
13	VBAT	RF PA Power Voltage Input	power			min	typ	max		
14	VBAT	RF PA Power Voltage Input				3.3	3.6	4.5	V	
15	VBAT	RF PA Power Voltage Input								
16	BGND	Ground								
17	TXD	UART1-Transmit Data	O		Output / 1	1				
18	RXD	UART1-Receive Data	I	PU	Input	Input				
19	RTS	UART1-Request To Send	O		Output / 1	1				
20	CTS	UART1-Clear To Send	I	PD	Input	Input				
21	DSR	UART1-Data Set Ready	I	PU	Input	Input				
22	IO8/DTR	GPIO 8/ Data Terminal Ready	O		1	Output / 0				
23	TDI	JTAG-Data Input	I	LPU	Input	Input				
24	IO 13	GPIO 13 / HW / Non flow control	I		Output / 1	Input				
25	TMS	JTAG-Test Mode Select	I	LPU	Input	Input				
26	TDO	JTAG-Data Output	O		Z	Z				
27	TCK	JTAG- Clock Input	I	LPD	Input	Input				
28	IO1	GPIO 1	O		Input	Output / 0				
29	IO 6	GPIO 6/Accessory_In	I		Input	Output / 1				
30	IO 11	Re-download function / audio switch	O		Input	Output / 0				
31	BGND		Ground							
32	AUXI	Auxiliary hands free amplifier negative input(-)	I			Input				
33	MICIN	Microphone amplifier negative input(-)	I			Input				
34	MICIP	Microphone amplifier positive input(+)	I			Input				
35	MICBIAS	Microphone bias supply	power			Output(2v/2.5v)				
36	HSMICB	Headset Microphone bias supply	power			Output(2v/2.5v)				
37	EARP	Earphone amplifier positive output(+)	O			Output				
38	EARN	Earphone amplifier negative output(-)	O			Output				
39	BGND		Ground							
40	AUXOP	Auxiliary hands free amplifier positive Output(+)	O			Output				
41	BGND		Ground							
42	SIM_RST	SIM Reset	O		0	Output				
43	SIM_IO	SIM Input / Output	I/O		0	Input / Output				
44	SIM_CLK	SIM Clock	O		0	Output				
45	VRSIM	Regulator SIM Output	O			Output				
46	LEDA	LED Driver, Paging Indicator	I			Input				
47	VBATRF	System Power Voltage Input	power			min	typ	max		
48	BGND	Ground				3.3	3.6	5.0	V	

UART/RS232

The UART includes the following additional features

- Hardware flow control (DSR, RTS/CTS)
- Auto-baud rate with the possibility of baud-rates ranging from 1200 to 115.2K bits.

Pin Name	Pin Out	Pull	Reset	Config	Description
TXD	17		1	Output/1	Transmit Data
RXD	18	PU	Input	Input	Receive Data
RTS	19		Output / 1	Output/1	Request to Send
CTS	20	PD	Input	Input	Clear to Send
DSR	21	PU	Input	Input	Data Set Ready
IO 8/DTR	22		1	Output/1	Data Terminal Ready

Note: The difference between Reset and Config is in the pin definition table

Pin IO 8 is dedicated to UART functions.

UART 2

Used for software debug.

Pin Name	Pin Out	Pull	Reset	Config	Description
TXD2	7		1	Output/1	Transmit Data
RXD2	8	PU	Input	Input	Receive Data

BU

When there is an incoming call, the Buzzer will generate a pulse.

Pin Name	Pin Out	Pull	Reset	Config	Description
BU	9		0	Output/0	Buzzer Output Pin

GPIO

The module provides 6 GPIO pins configurable in read or write mode.

Pin Name	Pin Out	Pull	Reset	Config	Description
IO 10	4		Input	Output/0	Module wake up external device
IO 13	24		1	Input	HW flow control enable
IO 6	29		Input	Output/1	Re-download data path and audio path switch
IO 11	30		Input	Output / 0	M32 Power off, connection between M32 and system (Host) open or short switch signal
IO 12	10		Input	Output/0	GPIO12
IO 1	28		Input	Output/0	GPIO1

Note : 1) IO 10 timing sequence is defined in design guide.

2) IO 1 and IO 12 was reserved .

LED Driver

LEDA is dedicated for paging identification.

The initial status is listed as follows:

- i. In the initial mode (no voltage input), this pin will be in HIGH status.
- ii. In standby mode it will be pulled low for **500 ms** and then pulled high for **500 ms**, alternately.
- iii. In active mode (Incoming call) it will be pulled low **125 ms** and pull high **125 ms** .

Pin Name	Pin Out	Pull	Reset	Config	Description
LEDA	46			Input	LED DRIVER, paging Indicator

Note : 1) The maximum current is 10 mA.

2) The LEDA voltage range is 0.4 V ~ VBATRF

SIM Function

The SIM Card digital interface in ABB insures the translation of logic levels between DBB and SIM Card for the transmission of 3 different signals: a clock signal, derived from a clock elaborated in DBB, to SIM Card (SIM_CLK); a reset signal, from DBB to the SIM Card (SIM_RST); and serial data from DBB to SIM Card (SIM_IO) and vice-versa.

Pin Name	Pin Out	Pull	Reset	Config	Description
SIM_CLK	44		0	Output	SIM Clock
SIM_RST	42		0	Output	SIM Reset
SIM_IO	43		0	Input /Output	SIM Input / Output
VRSIM (3V)	45			Output	Regulator SIM Output

VBAT

The maximum and minimum voltage will be defined in the [Electrical Characteristics Table](#).

Note: The Pins 13, 14, 15 are dedicated to the Power Amplifier (Pin 47 may be dedicated to RF and baseband)

Pin Name	Pin Out	Pull	Reset	Config	Description
VBAT	13			Input	RF PA Power Voltage input
VBAT	14			Input	RF PA Power Voltage input
VBAT	15			Input	RF PA Power Voltage input
VBATRF	47			Input	System Power Voltage input

Audio Function

There is a choice of differential EAR Phone output and differential Microphone input depending on customers' use. In addition, auxiliary pins can be used for hands-free.

Pin Name	Pin Out	Pull	Reset	Config	Description
EARP	37			Output	Earphone amplifier positive output(+)
EARN	38			Output	Earphone amplifier negative output(-)
MICP	34			Input	Microphone amplifier positive input(+)
MICN	33			Input	Microphone amplifier negative input(-)
AUXOP	40			Output	Auxiliary hands free amplifier positive output(+)
AUXI	32			Input	Auxiliary hands free amplifier negative input(-)
MICBIAS	35			Output	Microphone bias supply
HSMICB	36			Output	Headset Microphone bias supply

JTAG

Joined Test Action Group (JTAG) is used for debug purposes.

Pin Name	Pin Out	Pull	Reset	Config	Description
TDO	26		Z	Output	Data Output
TDI	23	LPU	Input	Input	Data Input
TCK	27	LPD	Input	Input	JTAG Clock
TMS	25	LPU	Input	Input	Test Mode Select

BGND

Pin Name	Pin Out	Pull	Reset	Config	Description
BGND	1				GND
BGND	3				GND
BGND	11				GND
BGND	12				GND
BGND	16				GND
BGND	31				GND
BGND	39				GND
BGND	41				GND
BGND	48				GND

Antenna

Pin Name	Pin Out	Pull	Reset	Config	Description
Ant	2				Antenna Pin(50 Ohm)

Interrupt

For dual processor use, an interrupt signal from the external processor can be sent to the module when needed.

Pin Name	Pin Out	Pull	Reset	Config	Description
IO10	4		Input	Output/0	Module wakes up host system
ROW 4	5	PU	Input	Input	External Device interrupt M32

Note: Detailed interrupt sequences between the host and module is given in the M32 design guide.

Power ON

The Power On Pin needs to be pulled low for at least 120ms to operate

Pin Name	Pin Out	Pull	Reset	Config	Description
PWON	6	PU		Input	Power On

Acoustic test (DAI interface)

Pin Name	Pin Out	Pull	Reset	Config	Description
MCSI_TXD/IO 9	(TP9)		0	0	Transmit serial data
MCSI_RXD/IO10	4		Input	Input	Receive serial data
MCSI_CLK/IO 11	30		Input	Input	Bit synchronization clock
MCSI_FSYNCH/IO 12	10		Input	Input	Frame synchronization clock or SS reset

Note: TP9 (Test point 9). The acoustic test pins above can be switched to IO pins using software control.

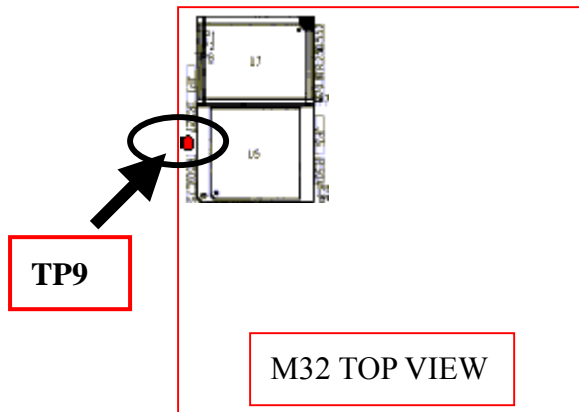

3.4. M32 Terminal Definition

BGND	1	48	BGND
ANT	2	47	VBATRF
BGND	3	46	LEDA
IO 10	4	45	VRSIM
ROW4	5	44	SIM_CLK
PWON	6	43	SIM_IO
TXD2	7	42	SIM_RST
RXD2	8	41	BGND
BU	9	40	AUXOP
IO 12/DCD	10	39	BGND
BGND	11	38	EARN
BGND	12	37	EARP
VBAT	13	36	HSMICB
VBAT	14	35	MICBIAS
VBAT	15	34	MICIP
BGND	16	33	MICIN
TXD	17	32	AUXI
RXD	18	31	BGND
RTS	19	30	IO 11
CTS	20	29	IO 6
DSR	21	28	IO 1/RI
IO 8/DTR	22	27	TCK
TDI	23	26	TDO
IO 13	24	25	TMS

3.5. Electrical Characteristics

Pin	Function /Name	Description		PARAMETER	Min	Typ	Max	Unit
1	GND	Ground						
2	ANT	Antenna						
3	GND	Ground						
4	IO10	GPIO :Input/Output 10	DIGI/O	(Voh)	2.24			V
				(Vol)			0.616	
				Rated current		2		mA
5	ROW4	Keyboard matrix 5*5 row access	Interrupt (Input)	(Vih)	1.96		3.3	V
				(Vil)	-0.5		0.84	
				Rated current		1		mA
6	PWON	POWER ON pin	Power On input	(Vih)	0.7*VBATRF			
				(Vil)			0.3*VBATRF	
7	TXD2	UART-IRDA: transmit data	DIGOUT	(Voh)	2.24			V
				(Vol)			0.616	
				Rated current		4		mA
8	RXD2	UART-IRDA: receive data	DIGIN	(Vih)	1.96		3.3	V
				(Vil)	-0.5		0.84	
				Rated current				mA
9	BU	Pulse width modulated signal for buzzer (OUTPUT)	PWM Signal OUT	(Voh)	345		5275	Hz
				(Vol)			0.616	
				Rated current		4		mA
10	IO12	GPIO:Input/Output12	DIGOUT	(Voh)	2.24			V
				(Vol)			0.616	
				Rated current		2		mA
11	GND	Ground						
12	GND	Ground						
13	VBAT	Battery voltage input			3.3	3.6	4.5	V
14	VBAT	Battery voltage input			3.3	3.6	4.5	
15	VBAT	Battery voltage input			3.3	3.6	4.5	
16	GND	Ground						
17	TXD	RS232: transmit data	DIGOUT	(Voh)	2.24			V
				(Vol)			0.616	
				Rated current		4		mA
18	RXD	RS232: receive data	DIGIN	(Vih)	1.96		3.3	V
				(Vil)	-0.5		0.84	
				Rated current		1		mA
19	RTS	RS232: request to send	DIGOUT	(Voh)	2.24			V
				(Vol)			0.616	
				Rated current		4		mA
20	CTS	RS232: Clear to send	DIGIN	(Vih)	1.96		3.3	V
				(Vil)	-0.5		0.84	
				Rated current				mA
21	DSR	RS232: Data set ready	DIGIN	(Vih)	1.96		3.3	V
				(Vil)	-0.5		0.84	
				Rated current				mA
22	IO 8/DTR	Data Terminal Ready	DIGOUT	(Voh)	2.24			V
				(Vol)			0.616	
				Rated current		2		mA
23	TDI	JTAG: data input	DIGIN	(Vih)	1.96		3.3	V
				(Vil)	-0.5		0.84	
				Rated current				mA
24	IO13	GPIO:Input/Output13	DIGIN/OUT	(Vih)	1.96		3.3	V
				(Vil)	-0.5		0.84	
				Rated current				mA
25	TMS	JTAG: test mode select	DIGIN	(Vih)	1.96		3.3	V
				(Vil)	-0.5		0.84	
				Rated current				mA
26	TDO	JTAG: data output	DIGOUT	(Voh)	2.24			V
				(Vol)			0.616	

Pin	Function /Name	Description	PARAMETER		Min	Typ	Max	Unit
				Rated current		2		mA
27	TCK	JTAG: clock (Input)	Clock	(Vih)	1.96		3.3	V
				(Vil)	-0.5		0.84	
28	IO 1	GPIO: Input/Output 1	DIGOUT	(Voh)	2.24			
				(Vol)			0.616	V
29	IO 6	GPIO: Input/Output 6	DIGOUT	Rated current		2mA		
				(Voh)	2.24			V
30	IO11	GPIO:Input/Output11	DIGOUT	(Vol)			0.616	V
				Rated current		2		mA
30	IO11	GPIO:Input/Output11	DIGOUT	(Voh)	2.24			V
				(Vol)			0.616	V
30	IO11	GPIO:Input/Output11	DIGOUT	Rated current		2		mA
				(Voh)	2.24			V
30	IO11	GPIO:Input/Output11	DIGOUT	(Vol)			0.616	V
				Rated current		2		mA
31	GND	Ground						
32	AUXI	Auxiliary microphone amplifier input: single ended				365		mVrms
33	MICIN	Microphone amplifier input(-)	Nominal Ref. Level (MICIP-MICIN)			-10		dBm0
			Differential input resistance (MICIP-MICIN)			100		dBm0
34	MICIP	Microphone amplifier input(+)				32.5		mVrms
35	MICBIAS	Microphone bias supply	DC-Power	MICBIAS=0		2		V
				MICBIAS=1		2.5		V
36	HSMICB	Headset Microphone bias supply	DC-Power	MICBIAS=0		2		V
				MICBIAS=1		2.5		V
37	EARP	Earphone amplifier output(+)		1.5 Vpp/Output swing 3.9 Vpp		33/120		ohms
38	EARN	Earphone amplifier output(-)		1.5 Vpp/Output swing 3.9 Vpp		33/120		ohms
39	GND	Ground						
40	AUXOP	Auxiliary hands free amplifier output(+)	Min. output resistive load	Min. output resistive load	1	1.2		Kohms
				Max. output capacitive load			100	pF
				Common mode min. resistive load at AUXOP or AUXON		200k		Ohms
				Common mode max. capacitive load at AUXOP or AUXON			10	pF
41	GND	Ground						
42	SIM_RST	SIM_reset	DIGOUT	(Voh)	0.7*VRSIM			V
				(Vol)			0.2*VRSIM	
				Rated Current		2		mA
				(Vol)			0.4	V
44	SIM_CLK	SIM_clock	CLKOUT	Rated Current		2		mA
				(Voh)	1M/3v		5M/3V	Hz/V
				(Vol)	0.7*VRSIM			V
				Rated Current		2		mA
45	VRSIM	Regulator SIM output		Active mode			10	mA
				Sleep mode			1	mA
				SIMSEL='0'	1.65	1.8	1.95	V
				SIMSEL='1' (Default)	2.7	2.85	3	V
46	LEDA	LED driver, paging	DIGOUT	Current			10	mA
				Supply voltage			VBATRF	V
47	VBATRF	Battery voltage input			3.3	3.6	5.0	V
48	GND	Ground						Ground

Operating Voltage/Current Characteristics

Parameter	Description	Min	Typ	Max	Unit
Supply Voltage range VBAT		3.0	3.6	5.0	V
Peak VBAT Current			1.8		A
Average VBAT Current		230		260	mA
Average Standby mode VBAT current	Paging Rate 9		3		mA
Vih	High-level input voltage	1.96		3.3	V
Vil	Low-level input voltage	-0.5		0.84	V
Voh	High-level output voltage	2.24			V
Vol	Low-level output voltage			0.616	V
SIM_CLK	Output frequency	1.625		3.25	MHz
VRSIM	SIMSEL=1	2.7	2.85	3.0	V

Audio Uplink Characteristics

Parameter	Conditions	Min	Typ	Max	Unit
Maximum Input Range (MICIP-MICIN)	Inputs 3 dBm0 (Maximum digital sample amplitude with PGA gain set to 0 dB)		32.5		mVrms
Nominal Ref. Level (MICIP-MICIN)			-10		dBm0
Differential Input Resistance			36		K Ω
Micro amplifier gain (MIC)			25.6		dB
Maximum Input Range (AUXI)	Input 3 dBm0 (Maximum digital sample amplitude with PGA gain set to 0dB)		365		mVrms
Nominal Ref. Level (AUXI)			-10		dBm0
Micro amplifier gain (AUXI)	VBDFAUXG=0		4.6		dB
	VBDFAUXG=1		28.2		dB
Input Resistance at AUXI	VBDFAUXG=0	100	170	24.5	K Ω
DC Level at MICBIAS	MICBIAS=0		2.0		Volt
DC Level at HSMICBIAS	MICBIAS=0		2.0		Volt
Current Capability at MICBIAS		0		2	mA
Current Capability at HSMICBIAS		0		2	mA

Note:

(1) All audio output was use same Bias - MICBIAS

(2) MICIP/MICIN and AUXI inputs are multiplexed, only one is available at the same time interval.

Audio Downlink Characteristics

Parameter	Conditions	Min	Typ	Max	Unit
Differential Minimum Resistive load at EARP-EARN	Output swing 3.9 Vpp		120		Ω
	Output swing 1.5 Vpp		33		Ω
Differential Maximum Resistive load at EARP-EARN				100	pF
Common Mode Minimum Resistive load at EARP-EARN			200		K Ω
Common Mode Maximum Resistive load at EARP-EARN				10	pF
Differential Minimum output resistive load at AUXOP		1	1.2		K Ω
Differential Minimum capacitor load at AUXOP				100	pF
Common Mode Minimum resistive load at AUXOP			200		K Ω
Common Mode Maximum Capacitor load at AUXOP				10	pF

Global Characteristics

Parameter	Conditions	Min	Typ	Max	Unit
Maximum Output Swing EARP – EARN	5% distortion and 120 Ω	3.1	3.92		Vpp
	5% distortion and 33 Ω	1.2	1.5		Vpp
Earphone amplifier gain			1		dB
Earphone amplifier state in power down			Hi-Z		
Maximum Output swing at AUXOP	5% distortion maximum, load = 1k Ω	1.6	1.96		Vpp
Auxiliary amplifier gain (AUXO)			-5		dB
AUXO amplifier state in power down			Hi-Z		
Power Supply Rejection			40		dB

3.6. Physical Package

Top View

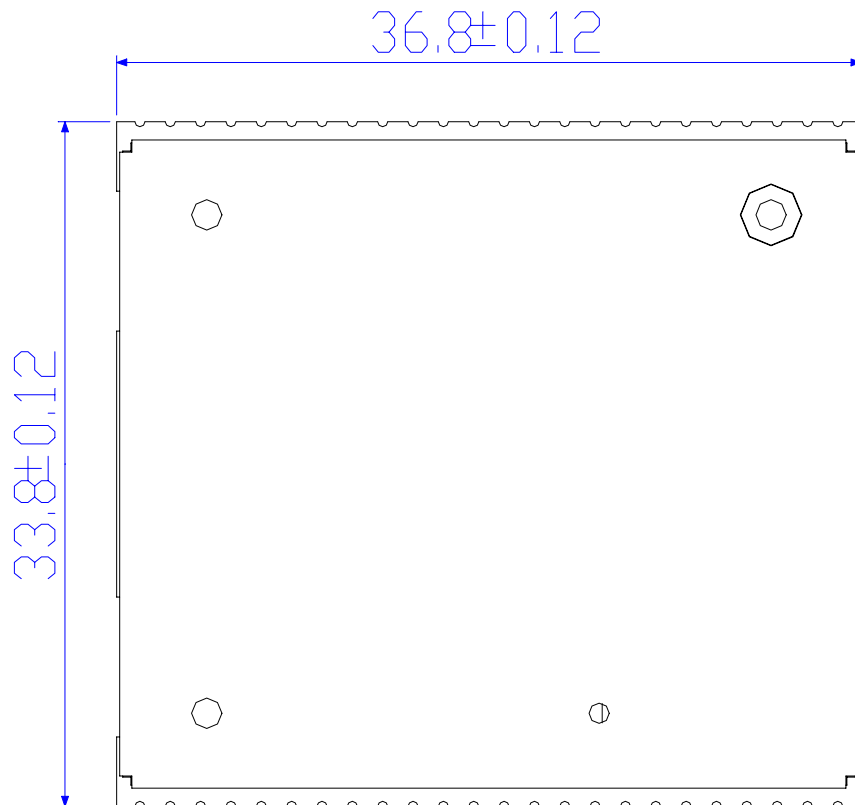

Side View

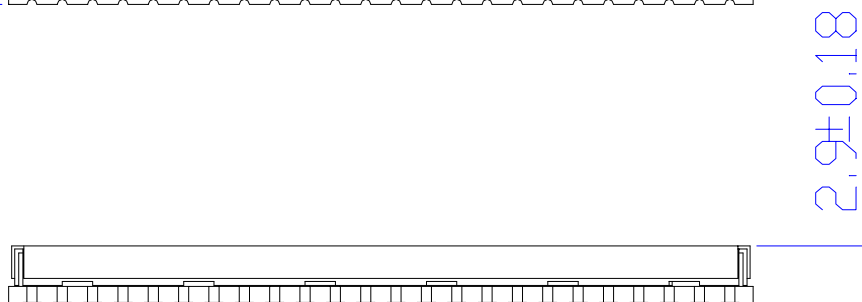

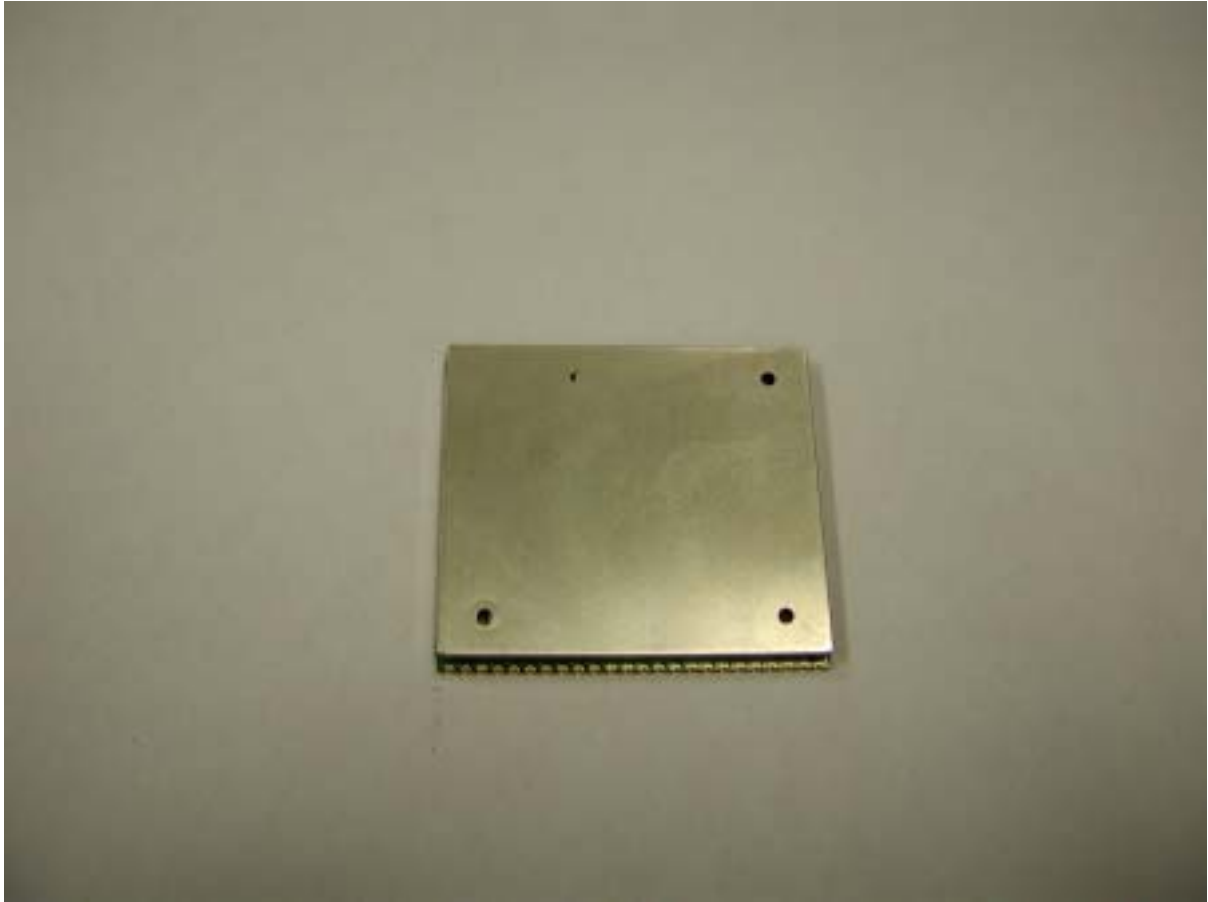
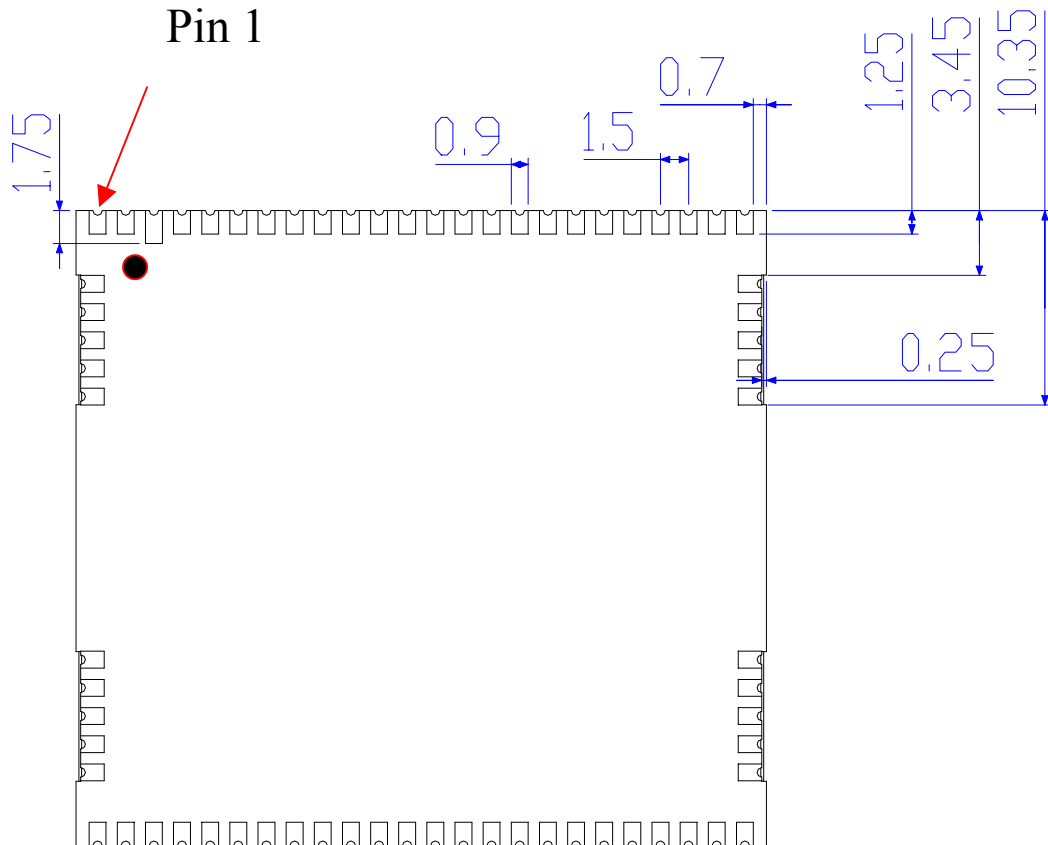

Fig. 1 Top View

Bottom View



Bottom View

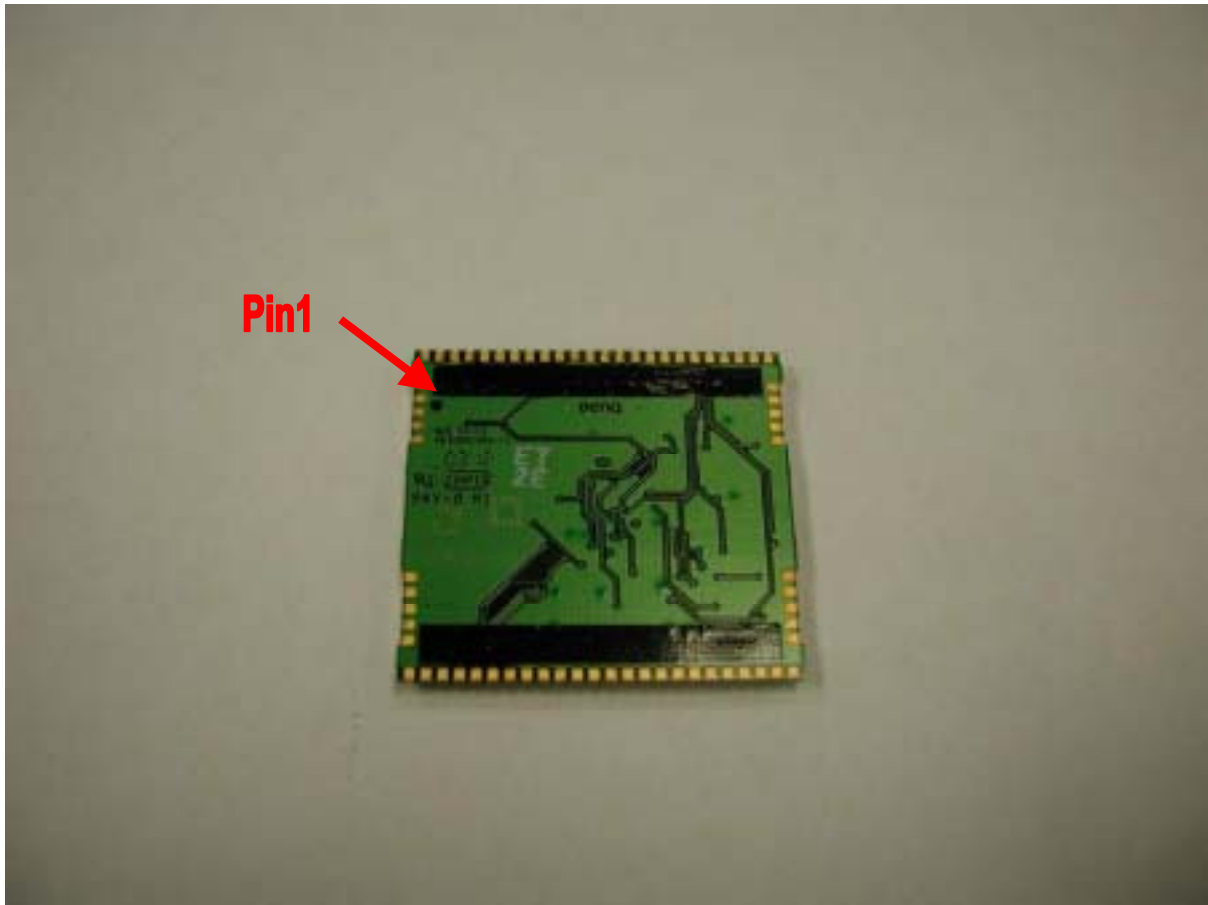

Fig 2 . Bottom View

4. Software Characteristics

4.1. Introduction

The following descriptions define the BenQ M32 LCC software architecture. For PDA customers, BenQ provides the supporting AT Commands. For telematics/notebook application, the following is needed: Address book, PC sync, Grouping by Ring Tones, and FAX.

4.2. Software Architecture

BenQ provides the Layer 1 driver and AT command. Based on different customer needs, different software architectures will be supported. This will be defined in the next section.

Architecture:

- Layer 1 Driver
- Protocol Stack/AT Command
- Basic interface

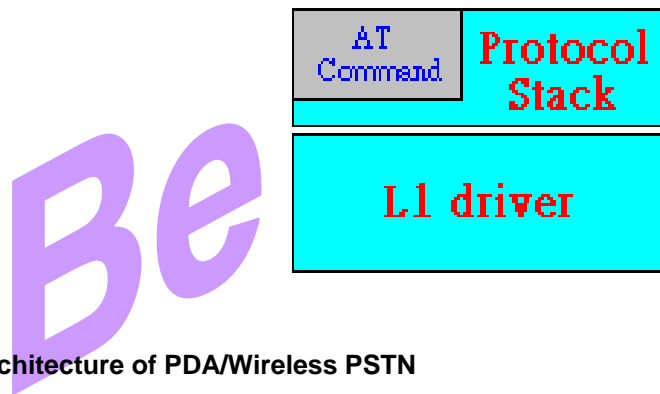

4.3. Software Architecture of PDA/Wireless PSTN

Due to the fact that there are both processors in BenQ's Module and the PDA, the common interface uses the AT Command. The software architecture was showed as the following diagram.

Customers can use BenQ provided AT Commands to access the GSM/GPRS network on their platform.

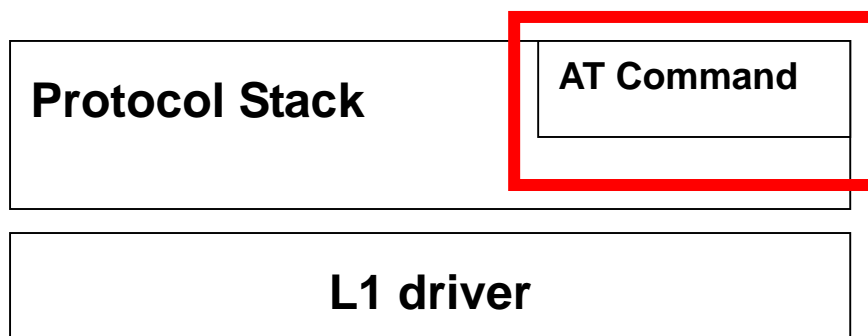

4.4. Software Architecture of Notebook

The software architecture for notebook applications is shown in the following diagram. The common interface between the notebook and module is the AT Command and AP software. Customers can use BenQ provided AP software/AT commands to access the GSM/GPRS network in their own Windows OS.

