

# 3GPP TR 36.942 V11.0.0 (2012-09)

---

*Technical Report*

## **3rd Generation Partnership Project; Technical Specification Group Radio Access Network; Evolved Universal Terrestrial Radio Access (E-UTRA); Radio Frequency (RF) system scenarios (Release 11)**



The present document has been developed within the 3<sup>rd</sup> Generation Partnership Project (3GPP<sup>TM</sup>) and may be further elaborated for the purposes of 3GPP.

The present document has not been subject to any approval process by the 3GPP Organizational Partners and shall not be implemented. This Specification is provided for future development work within 3GPP only. The Organizational Partners accept no liability for any use of this Specification. Specifications and reports for implementation of the 3GPP<sup>TM</sup> system should be obtained via the 3GPP Organizational Partners' Publications Offices.

---

Keywords

---

LTE, Radio

**3GPP**

Postal address

---

3GPP support office address

---

650 Route des Lucioles - Sophia Antipolis  
Valbonne - FRANCE  
Tel.: +33 4 92 94 42 00 Fax: +33 4 93 65 47 16

Internet

---

<http://www.3gpp.org>

---

**Copyright Notification**

---

No part may be reproduced except as authorized by written permission.  
The copyright and the foregoing restriction extend to reproduction in all media.

© 2012, 3GPP Organizational Partners (ARIB, ATIS, CCSA, ETSI, TTA, TTC).  
All rights reserved.

UMTS™ is a Trade Mark of ETSI registered for the benefit of its members  
3GPP™ is a Trade Mark of ETSI registered for the benefit of its Members and of the 3GPP Organizational Partners  
LTE™ is a Trade Mark of ETSI currently being registered for the benefit of its Members and of the 3GPP Organizational Partners  
GSM® and the GSM logo are registered and owned by the GSM Association

# Contents

Foreword .....	6
1 Scope .....	7
2 References.....	7
3 Definitions, symbols and abbreviations .....	8
3.1 Definitions .....	8
3.2 Symbols.....	8
3.3 Abbreviations.....	8
4 General assumptions .....	9
4.1 Interference scenarios .....	10
4.2 Antenna Models.....	10
4.2.1 BS antennas.....	10
4.2.1.1 BS antenna radiation pattern.....	10
4.2.1.2 BS antenna heights and antenna gains for macro cells .....	11
4.2.2 UE antenna .....	11
4.2.3 MIMO antenna Characteristics .....	11
4.3 Cell definitions .....	11
4.4 Cell layouts.....	12
4.4.1 Single operator cell layouts .....	12
4.4.1.1 Macro cellular deployment.....	12
4.4.2 Multi operator / Multi layer cell layouts .....	12
4.4.2.1 Uncoordinated macro cellular deployment .....	12
4.4.2.2 Coordinated macro cellular deployment .....	13
4.5 Propagation conditions and channel models.....	14
4.5.1 Received signal.....	14
4.5.2 Macro cell propagation model – Urban Area.....	14
4.5.3 Macro cell propagation model – Rural Area .....	15
4.6 Base-station model.....	15
4.7 UE model .....	17
4.8 RRM models .....	18
4.8.1 Measurement models .....	18
4.8.2 Modelling of the functions .....	18
4.9 Link level simulation assumptions .....	18
4.10 System simulation assumptions .....	18
4.10.1 System loading .....	18
5 Methodology description .....	18
5.1 Methodology for co-existence simulations .....	18
5.1.1 Simulation assumptions for co-existence simulations .....	18
5.1.1.1 Scheduler.....	18
5.1.1.2 Simulated services .....	19
5.1.1.3 ACIR value and granularity .....	19
5.1.1.4.1 Uplink Asymmetrical Bandwidths ACIR (Aggressor with larger bandwidth) .....	19
5.1.1.4.2 Uplink Asymmetrical Bandwidths ACIR (Aggressor with smaller bandwidth) .....	22
5.1.1.4 Frequency re-use and interference mitigation schemes for E-UTRA .....	22
5.1.1.5 CQI estimation .....	23
5.1.1.6 Power control modelling for E-UTRA and 3.84 Mcps TDD UTRA .....	23
5.1.1.7 SIR target requirements for simulated services .....	23
5.1.1.8 Number of required snapshots.....	23
5.1.1.9 Simulation output.....	23
5.1.2 Simulation description.....	24
5.1.2.1 Downlink E-UTRA interferer UTRA victim .....	24
5.1.2.2 Downlink E-UTRA interferer E-UTRA victim.....	24
5.1.2.3 Uplink E-UTRA interferer UTRA victim.....	25
5.1.2.4 Uplink E-UTRA interferer E-UTRA victim .....	25

6	System scenarios .....	26
6.1	Co-existence scenarios .....	26
7	Results .....	26
7.1	Radio reception and transmission.....	26
7.1.1	FDD coexistence simulation results.....	26
7.1.1.1	ACIR downlink 5MHz E-UTRA interferer – UTRA victim.....	26
7.1.1.2	ACIR downlink 10MHz E-UTRA interferer – 10MHz E-UTRA victim .....	27
7.1.1.3	ACIR uplink 5MHz E-UTRA interferer – UTRA victim.....	29
7.1.1.4	ACIR uplink 10MHz E-UTRA interferer – 10MHz E-UTRA victim.....	31
7.1.2	TDD coexistence simulation results .....	34
7.1.2.1	ACIR downlink 5MHz E-UTRA interferer – UTRA 3.84 Mcps TDD victim .....	34
7.1.2.2	ACIR downlink 10MHz E-UTRA interferer – 10MHz E-UTRA TDD victim .....	36
7.1.2.3	ACIR downlink 1.6 MHz E-UTRA interferer – UTRA 1.28 Mcps TDD victim.....	38
7.1.2.4	ACIR uplink 5MHz E-UTRA interferer – UTRA 3.84 Mcps TDD victim.....	41
7.1.2.5	ACIR uplink 10MHz E-UTRA interferer – 10MHz E-UTRA TDD victim.....	43
7.1.2.6	ACIR uplink 10MHz E-UTRA interferer – 10MHz E-UTRA TDD victim (LCR frame structure based).....	45
7.1.2.7	ACIR downlink 10MHz E-UTRA interferer – 10MHz E-UTRA TDD victim (LCR frame structure based) .....	46
7.1.3	Additional coexistence simulation results.....	48
7.1.3.1	ACIR downlink E-UTRA interferer – GSM victim.....	48
7.1.3.2	ACIR uplink E-UTRA interferer – GSM victim.....	50
7.1.3.3	Asymmetric coexistence 20 MHz and 5 MHz E-UTRA .....	51
7.1.3.4	Impact of cell range and simulation frequency on ACIR .....	53
7.1.3.5	Uplink Asymmetric coexistence TDD E-UTRA to TDD E-UTRA .....	54
7.1.4	Base station blocking simulation results .....	56
7.2	RRM .....	58
8	Rationales for co-existence requirements .....	58
8.1	BS and UE ACLR .....	58
8.1.1	Requirements for E-UTRA – UTRA co-existence.....	58
8.1.2	Requirements for E-UTRA – E-UTRA co-existence.....	59
9	Deployment aspects .....	59
9.1	UE power distribution.....	59
9.1.1	Simulation results .....	60
10	Multi-carrier BS requirements .....	62
10.1	Unwanted emission requirements for multi-carrier BS .....	62
10.1.1	General .....	62
10.1.2	Multi-carrier BS of different E-UTRA channel bandwidths .....	63
10.1.3	Multi-carrier BS of E-UTRA and UTRA.....	63
10.2	Receiver requirements for multi-carrier BS.....	64
10.2.1	General.....	64
10.2.2	Test principles for a multi-carrier BS of equal or different E-UTRA channel bandwidths .....	65
11	Rationale for unwanted emission specifications .....	65
11.1	Out of band Emissions.....	65
11.1.1	Operating band unwanted emission requirements for E-UTRA BS (spectrum emission mask).....	65
11.1.2	ACLR requirements for E-UTRA BS .....	67
11.2	Spurious emissions .....	69
11.2.1	BS Spurious emissions.....	69
11.2.2	General spurious emissions requirements for E-UTRA BS.....	69
11.2.3	Specification of BS Spurious emissions outside the operating band .....	70
11.2.4	Additional spurious emissions requirements .....	70
12	LTE-Advanced co-existence .....	71
12.1	Methodology and simulation assumptions for co-existence simulations.....	71
12.1.1	Simulation scenarios .....	71
12.1.2	Number of UEs per sub-frame .....	71
12.1.3	ACIR model .....	72
12.1.3.1	Uplink ACIR model .....	72
12.1.3.2	Downlink ACIR model .....	75

12.1.4	Uplink power control.....	76
12.2	Results .....	77
12.2.1	Radio reception and transmission.....	77
12.2.1.1	ACIR Downlink 40 MHz Advanced E-UTRA interferer – 10 MHz E-UTRA victim .....	77
12.2.1.2	ACIR Uplink 40 MHz Advanced E-UTRA interferer – 10 MHz E-UTRA victim.....	79
12.2.1.3	ACIR Downlink 40 MHz Advanced E-UTRA interferer – 40 MHz Advanced E-UTRA victim.....	83
12.2.1.4	ACIR Uplink 40 MHz Advanced E-UTRA interferer – 40 MHz Advanced E-UTRA victim .....	85
12.2.1.5	ACIR Downlink 40 MHz Advanced E-UTRA interferer – 5 MHz UTRA victim.....	89
12.2.1.6	ACIR Uplink 40 MHz Advanced E-UTRA interferer – 5 MHz UTRA victim .....	90
12.2.1.5	ACIR Downlink 40 MHz Advanced E-UTRA interferer – 1.6 MHz UTRA victim .....	92
12.2.1.6	ACIR Uplink 40 MHz Advanced E-UTRA interferer – 1.6 MHz UTRA victim.....	93
<b>Annex A (informative): Link Level Performance Model .....</b>		<b>96</b>
A.1	Description.....	96
A.2	Modelling of Link Adaptation.....	98
A.3	UTRA 3.84 Mcps TDD HSDPA Link Level Performance .....	99
A.4	Link Level Performance for E-UTRA TDD (LCR TDD frame structure based).....	101
<b>Annex B (informative): Smart Antenna Model for UTRA 1.28 Mcps TDD .....</b>		<b>103</b>
B.1	Description.....	103
<b>Annex C (informative): Simulation assumptions for LTE-A coexistence.....</b>		<b>107</b>
<b>Annex D (informative): Change history.....</b>		<b>109</b>

---

## Foreword

This Technical Report has been produced by the 3<sup>rd</sup> Generation Partnership Project (3GPP).

The contents of the present document are subject to continuing work within the TSG and may change following formal TSG approval. Should the TSG modify the contents of the present document, it will be re-released by the TSG with an identifying change of release date and an increase in version number as follows:

Version x.y.z

where:

- x the first digit:
  - 1 presented to TSG for information;
  - 2 presented to TSG for approval;
  - 3 or greater indicates TSG approved document under change control.
- y the second digit is incremented for all changes of substance, i.e. technical enhancements, corrections, updates, etc.
- z the third digit is incremented when editorial only changes have been incorporated in the document.

---

# 1 Scope

During the E-UTRA standards development, the physical layer parameters will be decided using system scenarios, together with implementation issues, reflecting the environments that E-UTRA will be designed to operate in.

---

# 2 References

The following documents contain provisions which, through reference in this text, constitute provisions of the present document.

- References are either specific (identified by date of publication, edition number, version number, etc.) or non-specific.
- For a specific reference, subsequent revisions do not apply.
- For a non-specific reference, the latest version applies. In the case of a reference to a 3GPP document (including a GSM document), a non-specific reference implicitly refers to the latest version of that document *in the same Release as the present document*.

- [1] 3GPP TR 25.896, "Feasibility Study for Enhanced Uplink for UTRA FDD"
- [2] 3GPP TR 25.816, "UMTS 900 MHz Work Item Technical Report"
- [3] 3GPP TR 25.942, "Radio Frequency (RF) system scenarios"
- [4] 3GPP TR 25.814, "Physical Layer Aspects for Evolved UTRA"
- [5] 3GPP TR 30.03, "Selection procedures for the choice of radio transmission technologies of the UMTS"
- [6] R4-051146, "Some operators' requirements for prioritization of performance requirements work in RAN WG4", RAN4#37
- [7] 3GPP TR 25.951, "FDD Base Station (BS) classification"
- [8] 3GPP TR 25.895, "Analysis of higher chip rates for UTRA TDD evolution."
- [9] R4-070235, "Analysis of co-existence simulation results", RAN4#42
- [10] R4-070084, "Coexistence Simulation Results for 5MHz E-UTRA -> UTRA FDD Uplink with Revised Simulation Assumptions", RAN4#42
- [11] R4-070034, "Additional simulation results on 5 MHz LTE to WCDMA FDD UL co-existence studies", RAN4#42
- [12] R4-070262, "Simulation results on 5 MHz LTE to WCDMA FDD UL co-existence studies with revised simulation assumptions", RAN4#42
- [13] R4-070263, "Proposal on LTE ACLR requirements for UE", RAN4#42
- [14] R4-061288, "Downlink LTE 900 (Rural Macro) with Downlink GSM 900 (Rural Macro) Co-existence Simulation Results", RAN4#41
- [15] R4-070391, "LTE 900 - GSM 900 Downlink Coexistence", RAN4#42bis
- [16] R4-061304, "LTE 900 - GSM 900 Uplink Simulation Results", RAN4#41
- [17] R4-070390, "LTE 900 - GSM 900 Uplink Simulation Results", RAN4#42bis
- [18] R4-070392 "LTE-LTE Coexistence with asymmetrical bandwidth", RAN4#42bis
- [19] 3GPP TS 36.104, "Base Station (BS) radio transmission and reception"

- [20] 3GPP TS 25.104, "Base Station (BS) radio transmission and reception (FDD)"
- [21] 3GPP TS 36.141, "Base Station (BS) conformance testing"
- [22] Recommendation ITU-R SM.329-10, "Unwanted emissions in the spurious domain"
- [23] "International Telecommunications Union Radio Regulations", Edition 2004, Volume 1 – Articles, ITU, December 2004.
- [24] "Adjacent Band Compatibility between UMTS and Other Services in the 2 GHz Band", ERC Report 65, Menton, May 1999, revised in Helsinki, November 1999.
- [25] "Title 47 of the Code of Federal Regulations (CFR)", Federal Communications Commission.
- [26] R4-070337, "Impact of second adjacent channel ACLR/ACS on ACIR" (Nokia Siemens Networks).
- [27] R4-070430, "UE ACS and BS ACLRs" (Fujitsu).
- [28] R4-070264, "Proposal on LTE ACLR requirements for Node B" (NTT DoCoMo).
- [29] Recommendation ITU-R M.1580-1, "Generic unwanted emission characteristics of base stations using the terrestrial radio interfaces of IMT-2000".
- [30] Report ITU-R M.2039, "Characteristics of terrestrial IMT-2000 systems for frequency sharing/interference analyses".
- [31] ETSI EN 301 908-3 V2.2.1 (2003-10), "Electromagnetic compatibility and Radio spectrum Matters (ERM); Base Stations (BS), Repeaters and User Equipment (UE) for IMT-2000 Third-Generation cellular networks; Part 3: Harmonized EN for IMT-2000, CDMA Direct Spread (UTRA FDD) (BS) covering essential requirements of article 3.2 of the R&TTE Directive".

---

## 3 Definitions, symbols and abbreviations

### 3.1 Definitions

### 3.2 Symbols

### 3.3 Abbreviations

For the purposes of the present document, the following abbreviations apply:

ACIR	Adjacent Channel Interference Ratio
ACLR	Adjacent Channel Leakage power Ratio
ACS	Adjacent Channel Selectivity
AMC	Adaptive Modulation and Coding
AWGN	Additive White Gaussian Noise
BS	Base Station
CDF	Cumulative Distribution Function
DL	Downlink
FDD	Frequency Division Duplex



MC	Monte-Carlo
MCL	Minimum Coupling Loss
MCS	Modulation and Coding Scheme
PC	Power Control
PSD	Power Spectral Density
RX	Receiver
TDD	Time Division Duplex
TX	Transmitter
UE	User Equipment
UL	Uplink

## 4 General assumptions

The present document discusses system scenarios for E-UTRA operation primarily with respect to the radio transmission and reception including the RRM aspects. To develop the E-UTRA standard, all the relevant scenarios need to be considered for the various aspects of operation and the most critical cases identified. The process may then be iterated to arrive at final parameters that meet both service and implementation requirements.

The E-UTRA system is intended to be operated in the same frequency bands specified for UTRA. In order to limit the number of frequency bands to be simulated in the various simulation scenarios a mapping of frequency bands to two simulation frequencies (900 MHz and 2000 MHz) is applied. When using the macro cell propagation model of TR25.942 [3], the frequency contributes to the path loss by  $21 \cdot \log_{10}(f)$ . The maximum path loss difference between the lowest/highest frequencies per E-UTRA frequency band and corresponding simulation frequency is shown in tables 4.1 and 4.2.

**Table 4.1: Simulation frequencies for FDD mode E-UTRA frequency bands**

E-UTRA Band	UL frequencies (MHz)		DL frequencies (MHz)		Simulation frequency (MHz)	Path loss difference (dB)	
	lowest	highest	lowest	highest		lowest UL frequency	highest DL frequency
1	1920	1980	2110	2170	2000	0.37	0.74
2	1850	1910	1930	1990	2000	0.71	0.05
3	1710	1785	1805	1880	2000	1.43	0.56
4	1710	1755	2110	2155	2000	1.43	0.68
5	824	849	869	894	900	0.80	0.06
6	830	840	875	885	900	0.74	0.15
7	2500	2570	2620	2690	2000	2.04	2.70
8	880	915	925	960	900	0.20	0.59
9	1749.9	1784.9	1844.9	1879.9	2000	1.22	0.56
10	1710	1770	2110	2170	2000	1.43	0.74
11	1427.9	1452.9	1475.9	1500.9	2000	3.07	2.62

**Table 4.2: Simulation frequencies for TDD mode E-UTRA frequency bands**

E-UTRA band	UL/DL frequencies (MHz)		Simulation frequency (MHz)	Path loss difference (dB)	
	lowest	highest		lowest frequency	highest frequency
33	1900	1920	2000	0.47	0.37
34	2010	2025	2000	0.05	0.11
35	1850	1910	2000	0.71	0.42
36	1930	1990	2000	0.32	0.05
37	1910	1930	2000	0.42	0.32
38	2570	2620	2000	2.29	2.46

It can be observed that the difference of path loss between simulation frequency and operating frequency (except bands 7, 11 and 38) is in the worst case less than 0.8 dB for the downlink and less the 1,5 dB for the uplink. Hence the mapping of operating frequency to simulation frequency will provide valid results.

The validity of simulations performed at 2 GHz for the 2.6 GHz bands 7 and 38 was already analyzed in TR 25.810. Considering the expected higher antenna gain in the 2.6 GHz band the difference in path loss is in the order of 1 dB what is comparable to the other frequency bands.

## 4.1 Interference scenarios

This chapter should cover how the interference scenarios could occur e.g. BS-BS, UE-BS etc.

## 4.2 Antenna Models

This chapter contains the various antenna models for BS and UE

### 4.2.1 BS antennas

#### 4.2.1.1 BS antenna radiation pattern

The BS antenna radiation pattern to be used for each sector in 3-sector cell sites is plotted in Figure 4.1. The pattern is identical to those defined in [1], [2] and [4]:

$$A(\theta) = -\min \left[ 12 \left( \frac{\theta}{\theta_{3dB}} \right)^2, A_m \right] \quad \text{where } -180 \leq \theta \leq 180,$$

$\theta_{3dB}$  is the 3dB beam width which corresponds to 65 degrees, and  $A_m = 20dB$  is the maximum attenuation

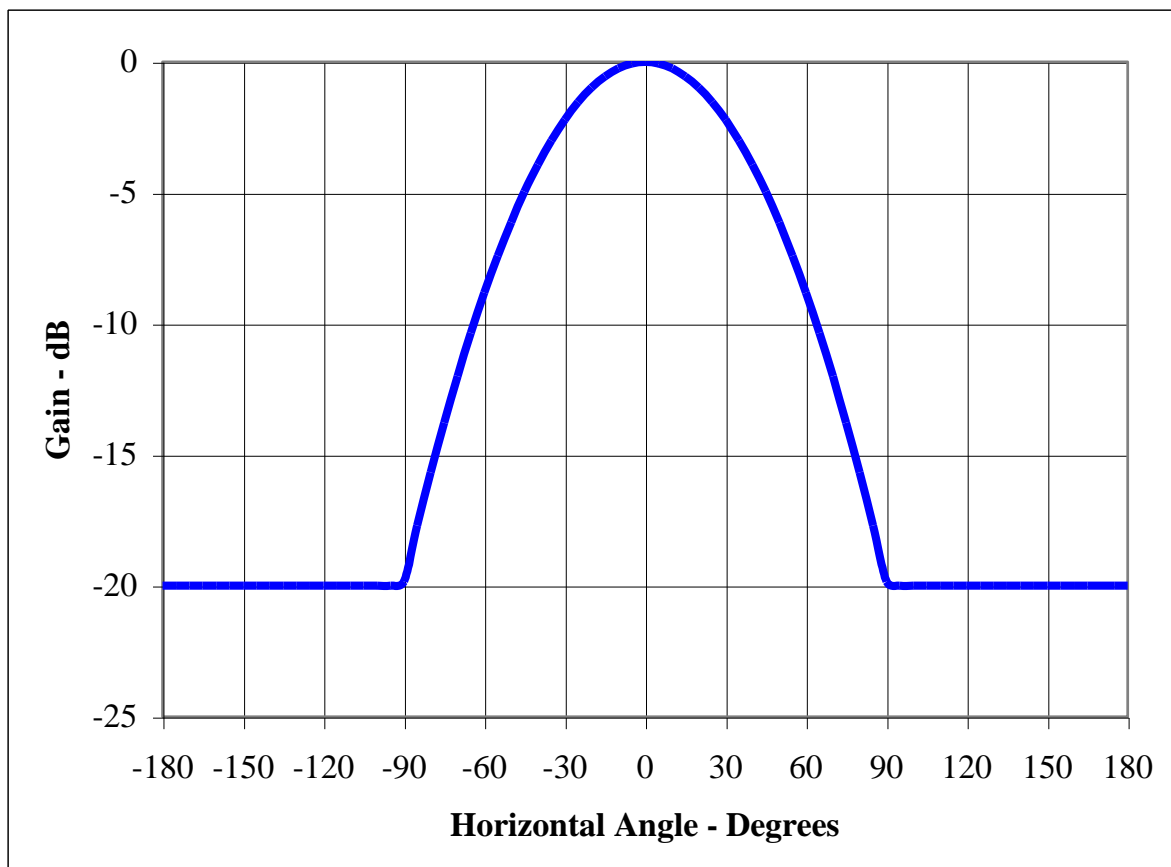

Figure 4.1: Antenna Pattern for 3-Sector Cells

4.2.1.2 BS antenna heights and antenna gains for macro cells

Antenna heights and gains for macro cells are given in table 4.3.

Table 4.3: Antenna height and gain for Macro Cells

	Rural Area	Urban Area	
	900 MHz	2000 MHz	900 MHz
BS antenna gain (dBi) (including feeder loss)	15	15	12
BS antenna height (m)	45	30	30

4.2.2 UE antenna

For UE antennas, a omni-directional radiation pattern with antenna gain 0dBi is assumed [2], [3], [4].

4.2.3 MIMO antenna Characteristics

xxxx

4.3 Cell definitions

This chapter contain the cell properties e.g. cell range, cell type (omni, sector), MIMO cell definitions etc.

## 4.4 Cell layouts

This chapter contains different cell layouts in form of e.g. single operator, multi-operator and multi layer cell layouts (e.g. macro-micro etc).

### 4.4.1 Single operator cell layouts

#### 4.4.1.1 Macro cellular deployment

Base stations with 3 sectors per site are placed on a hexagonal grid with distance of  $3 \cdot R$ , where  $R$  is the cell radius (see Figure 4.2), with wrap around. The number of sites shall be equal to or higher than 19. [2] [4].

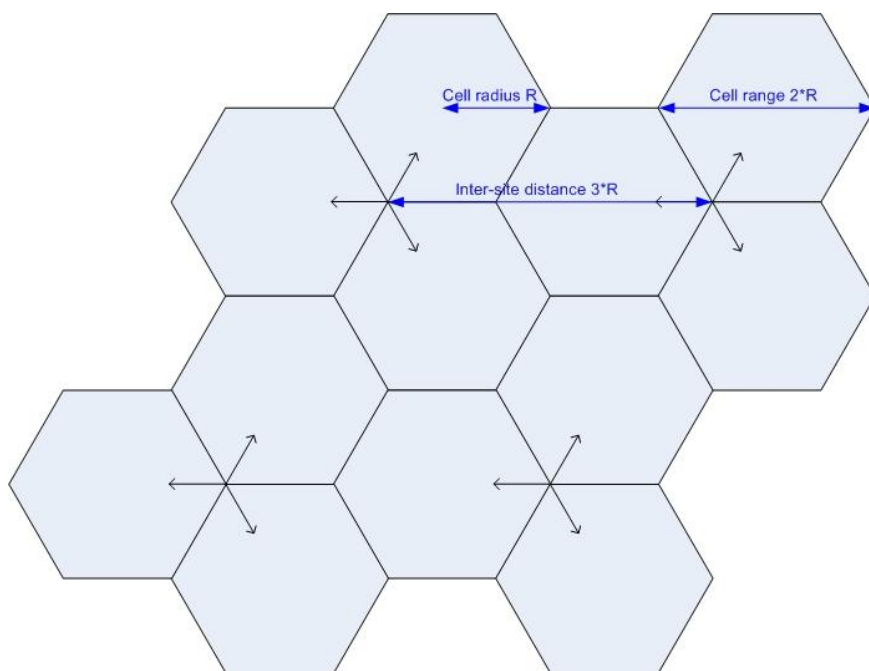
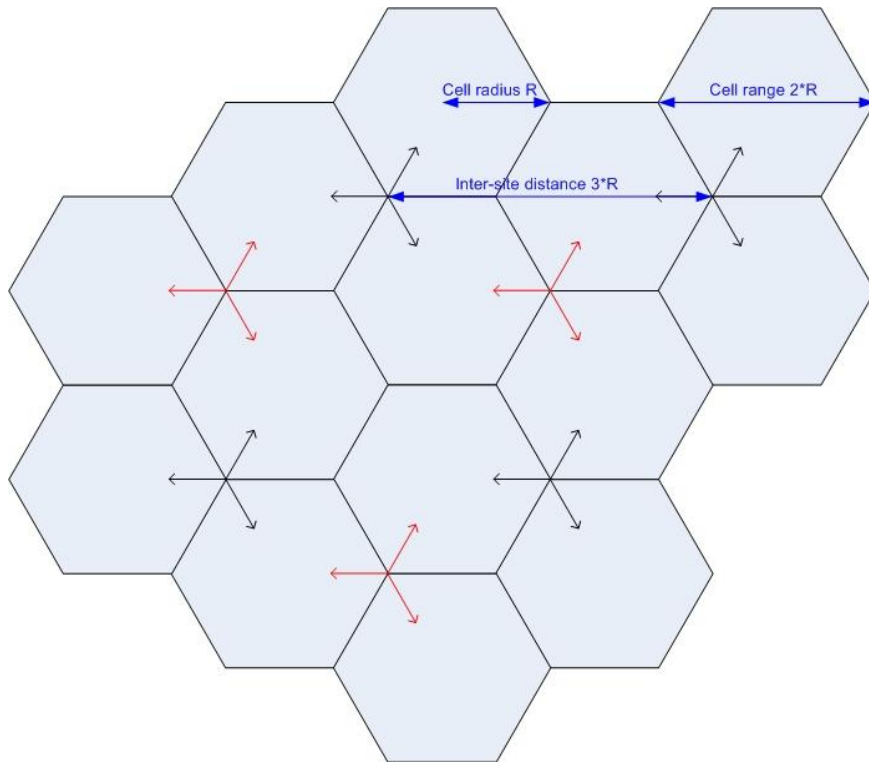

Figure 4.2: Single operator cell layout

### 4.4.2 Multi operator / Multi layer cell layouts

#### 4.4.2.1 Uncoordinated macro cellular deployment

For uncoordinated network simulations, identical cell layouts for each network shall be applied, with worst case shift between sites. Second network's sites are located at the first network's cell edge, as shown in Figure 4.3 [2].



**Figure 4.3: Multi operator cell layout - uncoordinated operation**

#### 4.4.2.2 Coordinated macro cellular deployment

For coordinated network simulations, co-location of sites is assumed; hence identical cell layouts for each network shall be applied [2].

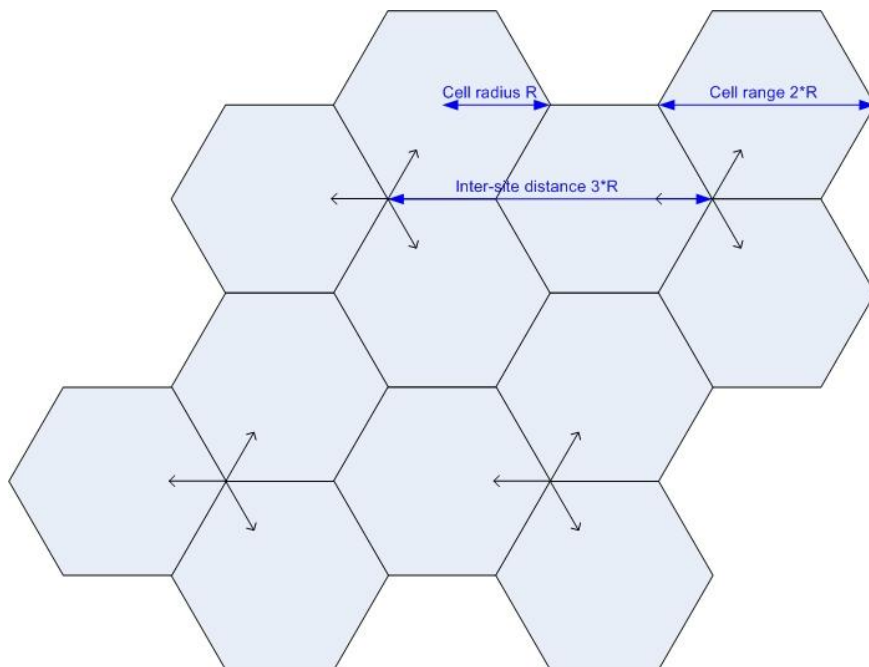

**Figure 4.4: Multi operator cell layout - coordinated operation**

## 4.5 Propagation conditions and channel models

This chapter contains the definition of channel models, propagation conditions for various environments e.g. urban, suburban etc.

For each environment a propagation model is used to evaluate the propagation pathloss due to the distance. Propagation models are adopted from [3] and [4] and presented in the following clauses.

### 4.5.1 Received signal

An important parameter to be defined is the minimum coupling loss (MCL). MCL is the parameter describing the minimum loss in signal between BS and UE or UE and UE in the worst case and is defined as the minimum distance loss including antenna gains measured between antenna connectors. MCL values are adopted from [3] and [7] as follows:

**Table 4.4: Minimum Coupling Losses**

Environment	Scenario	MCL
Macro cell Urban Area	BS ↔ UE	70 dB
Macro cell Rural Area	BS ↔ UE	80 dB

With the above definition, the received power in downlink and uplink can be expressed as [3]:

$$RX\_PWR = TX\_PWR - \text{Max}(\text{pathloss} - G\_TX - G\_RX, \text{MCL})$$

where:

RX\_PWR is the received signal power

TX\_PWR is the transmitted signal power

G\_TX is the transmitter antenna gain

G\_RX is the receiver antenna gain

### 4.5.2 Macro cell propagation model – Urban Area

Macro cell propagation model for urban area is applicable for scenarios in urban and suburban areas outside the high rise core where the buildings are of nearly uniform height [3]:

$$L = 40 \cdot (1 - 4 \cdot 10^{-3} \cdot D_{hb}) \cdot \log_{10}(R) - 18 \cdot \log_{10}(D_{hb}) + 21 \cdot \log_{10}(f) + 80\text{dB}$$

where:

R is the base station-UE separation in kilometres

f is the carrier frequency in MHz

D<sub>hb</sub> is the base station antenna height in metres, measured from the average rooftop level

Considering a carrier frequency of 900MHz and a base station antenna height of 15 metres above average rooftop level, the propagation model is given by the following formula [4]:

$$L = 120,9 + 37,6 \log_{10}(R)$$

where:

R is the base station-UE separation in kilometres

Considering a carrier frequency of 2000MHz and a base station antenna height of 15 metres above average rooftop level, the propagation model is given by the following formula:

$$L = 128,1 + 37,6 \log_{10}(R)$$

where:

R is the base station-UE separation in kilometres

After L is calculated, log-normally distributed shadowing (LogF) with standard deviation of 10dB should be added [2], [3]. A Shadowing correlation factor of 0.5 for the shadowing between sites (regardless aggressing or victim system) and of 1 between sectors of the same site shall be used. The pathloss is given by the following formula:

$$\text{Pathloss}_{\text{macro}} = L + \text{LogF}$$

NOTE 1: L shall in no circumstances be less than free space loss. This model is valid for NLOS case only and describes worse case propagation

NOTE 2: The pathloss model is valid for a range of D<sub>hb</sub> from 0 to 50 metres.

NOTE 3: This model is designed mainly for distance from few hundred meters to kilometres. This model is not very accurate for short distances.

NOTE 4: The mean building height is equal to the sum of mobile antenna height (1,5m) and  $\Delta h_m = 10,5\text{m}$  [5].

NOTE 5: Some downlink simulations in this TR were performed without shadowing correlation, however it was reported this has a negligible impact on the simulation results.

### 4.5.3 Macro cell propagation model – Rural Area

For rural area, the Hata model was used in the work item UMTS900[2], this model can be reused:

$$L(R) = 69,55 + 26,16 \log_{10}(f) - 13,82 \log_{10}(H_b) + [44,9 - 6,55 \log_{10}(H_b)] \log(R) - 4,78 (\log_{10}(f))^2 + 18,33 \log_{10}(f) - 40,94$$

where:

R is the base station-UE separation in kilometres

f is the carrier frequency in MHz

H<sub>b</sub> is the base station antenna height above ground in metres

Considering a carrier frequency of 900MHz and a base station antenna height of 45 meters above ground the propagation model is given by the following formula:

$$L = 95,5 + 34,1 \log_{10}(R)$$

where:

R is the base station-UE separation in kilometres

After L is calculated, log-normally distributed shadowing (LogF) with standard deviation of 10dB should be added [2], [3]. A Shadowing correlation factor of 0.5 for the shadowing between sites (regardless aggressing or victim system) and of 1 between sectors of the same site shall be used. The pathloss is given by the following formula:

$$\text{Pathloss}_{\text{macro}} = L + \text{LogF}$$

NOTE 1: L shall in no circumstances be less than free space loss. This model is valid for NLOS case only and describes worse case propagation

NOTE 2: This model is designed mainly for distance from few hundred meters to kilometres. This model is not very accurate for short distances.

## 4.6 Base-station model

This chapter covers the fundamental BS properties e.g. output power, dynamic range, noise floor etc.

Reference UTRA FDD base station parameters are given in Table 4.5.

**Table 4.5: UTRA FDD reference base station parameters**

Parameter	Value	Note
Maximum BS power	43dBm	[2], [3]
Maximum power per DL traffic channel	30dBm	[2], [3]
Minimum BS power per user	15dBm	[2]
Total CCH power	33dBm	[2]
Noise Figure	5dB	[3]

Reference base station parameters for UTRA 1.28Mcps TDD are given in Table 4.5a.

**Table 4.5a: Reference base station for UTRA 1.28Mcps TDD**

Parameter	Value	Note
Maximum BS power	34dBm	
Maximum power per DL traffic channel	22dBm	$34-10*\log_{10}(16)=22\text{dBm}$
power control dynamic	30dB	
Noise Figure	7dB	
Noise power	-106dBm	
Reference sensitivity	-110dBm	
Target CIR for 12.2kbps voice	-2.5 dB	

Reference UTRA 3.84 Mcps TDD base station parameters are given in Table 4.5b.

**Table 4.5b: Reference base station for UTRA 3.84Mcps TDD**

Parameter	Value	Note
Maximum BS Power	43 dBm	
Max power per DL traffic channel	Up to the maximum base station transmit power may be assigned to each timeslot and users may be multiplexed between timeslots	
Noise Figure	5 dB	

Reference E-UTRA FDD and E-UTRA TDD base station parameters are given in Table 4.6.

**Table 4.6: E-UTRA FDD and E-UTRA TDD reference base station parameters**

Parameter	Value	Note
Maximum BS power	43dBm for 1.25, 2.5 and 5MHz carrier 46dBm for 10, 15 and 20MHz carrier	[4]
Maximum power per DL traffic channel	32dBm	
Noise Figure	5dB	[4]

Reference base station parameters for E-UTRA TDD (LCR TDD frame structure based) are given in Table 4.6a.

**Table 4.6a: Reference base station for E-UTRA TDD (LCR TDD frame structure based)**

Parameter	Value	Note
Maximum BS power	43dBm for bandwidth $\leq 5\text{MHz}$ 46dBm for 10, 15 and 20MHz bandwidth	
Maximum power per RB	Maximum BS power/ Nr. of available RB's	375kHz RB size*
Noise Figure	6dB	
Noise power	Varies with system BW	Noise power should be calculated based on different BW option.

NOTE: \* When there is new decision in RAN1, new RB size for 1.6MHz should be reconsidered.



## 4.7 UE model

This chapter covers the fundamental UE properties e.g. output power, dynamic range, noise floor etc.

Reference UTRA FDD parameters are given in Table 4.7.

**Table 4.7: UTRA FDD reference UE parameters**

Parameter	Value	Note
Maximum UE power	21dBm	[2], [3]
Minimum UE power	-50dBm	[2]
Noise Figure*	9dB	[3]

NOTE: \* UTRA TDD UE will have a relatively lower Noise Figure since it does not have a duplexer. However, for simulation alignment purpose, a Noise Figure of 9 dB will be used.

Reference UTRA 1.28 Mcps TDD parameters are given in Table 4.7a

**Table 4.7a: Reference UE for UTRA 1.28 Mcps TDD**

Parameter	Value	Note
Maximum UE power	21dBm	
Minimum UE power	-49dBm	
Noise Figure	9dB	
Antenna model	0dBi	
Noise power	-104dBm	
Reference sensitivity	-108dBm	
Target CIR	-2.5 dB	

Reference UTRA 3.84 Mcps TDD UE parameters are given in Table 4.7b.

**Table 4.7b: UTRA 3.84 Mcps TDD reference UE parameters**

Parameter	Value	Note
Maximum UE power	24dBm	[2], [3]
Minimum UE power	-50dBm	[2]
Noise Figure*	9dB	[3]

NOTE: \* UTRA TDD UE will have a relatively lower Noise Figure since it does not have a duplexer. However, for simulation alignment purpose, a Noise Figure of 9 dB will be used.

Reference E-UTRA FDD and E-UTRA TDD UE parameters are given in Table 4.8.

**Table 4.8: E-UTRA FDD and E-UTRA TDD reference UE parameters**

Parameter	Value	Note
Maximum UE power	24dBm	[6]
Minimum UE power	-30dBm	[3]
Noise Figure*	9dB	[4]

NOTE: \* E-UTRA TDD UE will have a relatively lower Noise Figure since it does not have a duplexer. However, for simulation alignment purpose, a Noise Figure of 9 dB will be used.

Reference E-UTRA TDD UE (LCR TDD frame structure based) parameters are given in Table 4.8a.

**Table 4.8a: Reference UE for EUTRA TDD (LCR TDD frame structure based)**

Parameter	Value	Note
Maximum UE power	24dBm	
Minimum UE power	-30dBm	
Noise Figure	9dB	
Noise power	Varies with the total RB's allocated for a UE	

## 4.8 RRM models

This chapter contains models that are necessary to study the RRM aspects e.g.

### 4.8.1 Measurement models

xxxx

### 4.8.2 Modelling of the functions

xxxx

## 4.9 Link level simulation assumptions

This chapter covers Layer 1 aspects and assumptions (e.g. number of HARQ retransmissions) etc.

## 4.10 System simulation assumptions

This chapter contains system simulation assumptions e.g. Eb/No values for different services, activity factor for voice, power control steps, performance measures (system throughput, grade of service), confidence interval etc.

### 4.10.1 System loading

xxxx

---

# 5 Methodology description

This chapter describes the methods used for various study items e.g. deterministic analysis for BS-BS interference, Monte-Carlo simulations and dynamic type of simulations for RRM.

## 5.1 Methodology for co-existence simulations

Simulations to investigate the mutual interference impact of E-UTRA, UTRA and GERAN are based on snapshots where users are randomly placed in a predefined deployment scenario (Monte-Carlo approach). Assumptions on E-UTRA in this chapter are based on the physical layer (OFDMA DL and SC-FDMA UL) as described in the E-UTRA study item report [4]. It must be noted that actual E-UTRA physical layer specification of frequency resource block is different regarding number of sub-carriers per resource block (12 instead of 25 specified in [4]) and regarding the size of a resource block (180 kHz instead of 375 kHz in [4]). However, this has no impact on the results and conclusions of the present document.

### 5.1.1 Simulation assumptions for co-existence simulations

#### 5.1.1.1 Scheduler

For initial E-UTRA coexistence simulations Round Robin scheduler shall be used.

### 5.1.1.2 Simulated services

When using Round Robin scheduler, full buffer traffic shall be simulated. For E-UTRA downlink, one frequency resource block for one user shall be used. The E-UTRA system shall be maximum loaded, i.e. 24 frequency resource blocks in 10 MHz bandwidth and 12 frequency resource blocks in 5 MHz bandwidth respectively. For E-UTRA uplink, the number of allocated frequency resource blocks for one user is 4 for 5 MHz bandwidth and 8 for 10 MHz bandwidth respectively.

For the 5 MHz TDD UTRA victim using 3.84 Mcps TDD, Enhanced Uplink providing data service shall be used where 1 UE shall occupy 1 Resource Unit (code x timeslot). Here the number of UE per timeslot is set to 3 UEs/timeslot.

Other services, e.g. constant bit rate services are FFS.

### 5.1.1.3 ACIR value and granularity

For downlink a common ACIR for all frequency resource blocks to calculate inter-system shall be used. Frequency resource block specific ACIR is FFS.

For uplink it is assumed that the ACIR is dominated by the UE ACLR. The ACLR model is described in table 5.1 and table 5.2

**Table 5.1: ACLR model for 5MHz E-UTRA interferer and UTRA victim, 4 RBs per UE**

Location of aggressor 4RBs (bandwidth = 4*375 kHz)	Adjacent to victim channel edge	at least 4 RBs away from channel edge
ACLR dBc/3.84MHz	30 + X	43+X
X serves as the step size for simulations, X = ... -10, -5, 0, 5, 10... dB		

**Table 5.2: ACLR model for E-UTRA interferer and 10MHz E-UTRA victim**

E-UTRA	Number of RBs per UE	Bandwidth (B <sub>Aggressor</sub> )	ACLR dB/ B <sub>Aggressor</sub>	
			Adjacent to edge of victim RBs	Non Adjacent to edge of victim RBs
5 MHz	4	4 RB (4 × 375 kHz)	30 + X (less than 4 RBs away)	43 + X (more than 4 RBs away)
10 MHz	8	8 RB (8 × 375 kHz)	30 + X (less than 8 RBs away)	43 + X (more than 8 RBs away)
15 MHz	12	12 RB (12 × 375 kHz)	30 + X (less than 12 RBs away)	43 + X (more than 12 RBs away)
20 MHz	16	16 RB (16 × 375 kHz)	30 + X (less than 16 RBs away)	43 + X (more than 16 RBs away)
X serves as the step size for simulations, X = ... -10, -5, 0, 5, 10... dB				

Note: This ACLR models are agreed for the purpose of co-existence simulations. ACLR/ACS requirements need to be discussed separately.

#### 5.1.1.4.1 Uplink Asymmetrical Bandwidths ACIR (Aggressor with larger bandwidth)

Since the uplink ACLR of the aggressor is measured in the aggressor's bandwidth, for uplink asymmetrical bandwidth coexistence, a victim UE with a smaller bandwidth than that of the aggressor will receive a fraction of the interference power caused by the aggressor's ACLR. For two victim UEs falling within the 1st ACLR of the aggressor, the victim UE closer in frequency to the aggressor will experience higher interference than one that is further away in frequency. The difference in interference depends on the power spectral density (PSD) within the aggressor's 1st ACLR bandwidth. For simplicity, it is assumed that the PSD is flat across the aggressor's ACLR bandwidth. Hence, the ACLR can be adjusted by the factor, F<sub>ACLR</sub>:

$$F_{ACLR} = 10 \times \text{LOG}_{10}(B_{\text{victim}}/B_{\text{Aggressor}})$$

Where, B<sub>Aggressor</sub> and B<sub>Victim</sub> are the E-UTRA aggressor and victim bandwidths respectively.

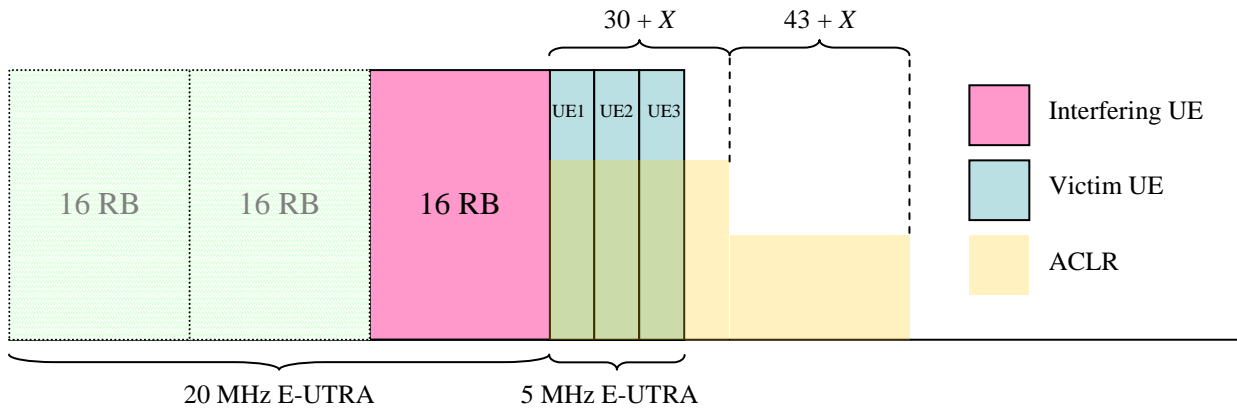

Figure 5.1: 20 MHz E-UTRA UE aggressor to 5 MHz E-UTRA UE victims

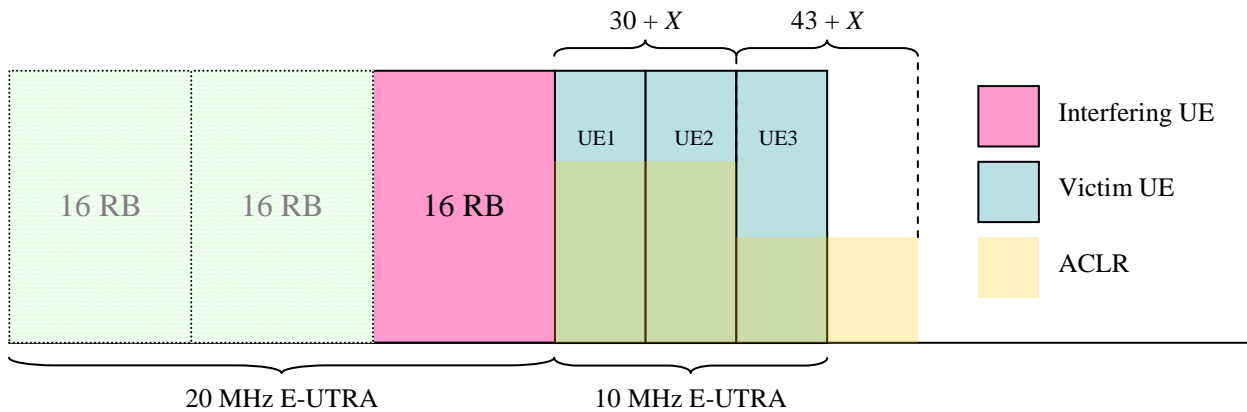

Figure 5.2: 20 MHz E-UTRA UE aggressor to 10 MHz E-UTRA UE victims

In Table 5.2, the aggressor UE that is non adjacent to the victim UE, the victim UE will experience an interference due to an ACLR of  $43 + X - F_{ACLR}$ . For the case where the aggressor UE is adjacent to the victim UEs, consider the scenarios in Figure 5.1, 5.2 and 5.3, where a 20 MHz E-UTRA aggressor is adjacent to 3 victim UEs of 5 MHz, 10 MHz and 15 MHz E-UTRA systems respectively.

In Figure 5.1, all the UEs in the 5 MHz E-UTRA system will be affected by an ACLR of  $30 + X - F_{ACLR}$ . For the 10 MHz E-UTRA victims in Figure 5.2, two UEs will be affected by an ACLR of  $30 + X - F_{ACLR}$  whilst 1 UE will be affected by a less severe ACLR of  $43 + X - F_{ACLR}$ . In the 15 MHz E-UTRA victim as shown in Figure 5.3, the UE next to the band edge will be affected by an ACLR of  $30 + X - F_{ACLR}$  whilst the UE farthest from the band edge will be affected by an ACLR of  $43 + X - F_{ACLR}$ . The victim UE of the 15 MHz E-UTRA occupying the centre RB (2nd from band edge) is affected by 1/3 ACLR of  $30 + X - F_{ACLR}$  and 2/3 ACLR of  $43 + X - F_{ACLR}$ . This gives an ACLR of  $34 + X - F_{ACLR}$ .

Using a similar approach for 15 MHz, 10 MHz and 5 MHz aggressor with a victim of smaller system bandwidth, the ACLR affecting each of the 3 victim UEs can be determined. This is summarised in Table 5.2A. Here the value Y is defined for victim UE, where  $ACLR = Y + X - F_{ACLR}$ . UE1 is the UE adjacent to the aggressor, UE2 is located at the centre and UE3 is furthest away from the aggressor.

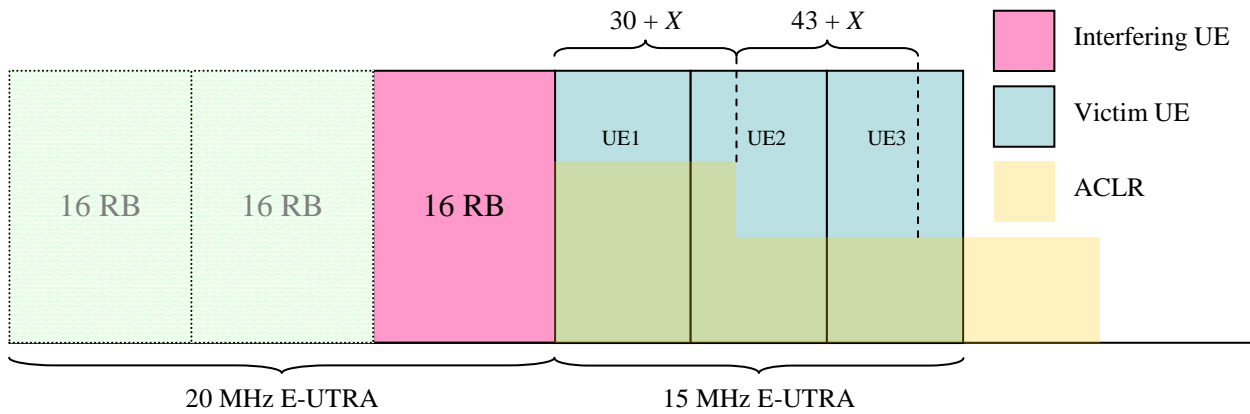

Figure 5.3: 20 MHz E-UTRA UE aggressor to 15 MHz E-UTRA UE victims

Table 5.2A: Value Y (ACLR = Y + X - F<sub>ACLR</sub>) for larger aggressor bandwidth

Aggressor	Victim: Value Y (dB): ACLR = (Y + X - F <sub>ACLR</sub> )											
	15 MHz			10 MHz			5 MHz			1.6 MHz		
	UE1	UE2	UE3	UE1	UE2	UE3	UE1	UE2	UE3	UE1	UE2	UE3
20 MHz	30	34	43	30	30	43	30	30	30	30	30	30
15 MHz				30	32	43	30	30	30	30	30	30
10 MHz							30	30	43	30	30	30
5 MHz										30	30	30

The victims in 10 MHz system under a 20 MHz aggressor experience slightly worse interference than the victims in 15 MHz system under a 20 MHz aggressor and therefore, we only need to consider the worst of the two cases. Hence, from Table 5.2A, the total number of asymmetrical bandwidth coexistences can be reduced to 3 scenarios and they are summarised in Table 5.2B. The performance of the other scenarios can be derived from these 3 base scenarios by factoring in the F<sub>ACLR</sub> factor in the ACLR.

Table 5.2B: Base scenarios (F<sub>ACLR</sub> = 0 dB)

Scenario	System Bandwidth (MHz)		Value Y (dB), ACLR = Y + X		
	Aggressor	Victim	UE1	UE2	UE3
1	15	10	30	32	43
2	20	10	30	30	43
3	20	5	30	30	30

An additional factor will be required to cater for the differences in UE transmit powers, which are dependent upon the power control scheme used in Table 5.3. Given the power control scheme, a UE with higher bandwidth will transmit at higher overall power (note: max UE transmit power remains the same). Thus, an aggressor with higher transmit power than the aggressor in the base scenario needs to increase its ACLR. On the other hand, for an interference limited environment, a victim with higher transmit power can overcome higher level of interference and hence demands a relaxed ACLR from its aggressor. The differences in transmit powers are given in the power control factor, P<sub>ACLR</sub> and it is dependent upon the CL<sub>X-ile</sub> of the aggressors and victims. P<sub>ACLR</sub> is given as:

$$P_{ACLR} \text{ (dB)} = (CL_{X-ile_{BaseAggressor}} - CL_{X-ile_{Aggressor}}) + (CL_{X-ile_{Victim}} - CL_{X-ile_{BaseVictim}})$$

Where, CL<sub>X-ile<sub>BaseAggressor</sub></sub> and CL<sub>X-ile<sub>BaseVictim</sub></sub> are the CL<sub>X-ile</sub> used by the aggressor and the victim respectively in the base scenario in Table 5.2B. CL<sub>X-ile<sub>Aggressor</sub></sub> and CL<sub>X-ile<sub>Victim</sub></sub> are the CL<sub>X-ile</sub> of the aggressor and victim of interest respectively. For example, using Power Control Set 1, for the scenario 10 MHz (aggressor) to 5 MHz (victim), CL<sub>X-ile<sub>Aggressor</sub></sub> = 112 and CL<sub>X-ile<sub>Victim</sub></sub> = 115 dB. The base scenario used is Scenario 2 of Table 5.2B (20 MHz (aggressor) to 10 MHz (victim)). Hence, in this example, CL<sub>X-ile<sub>BaseAggressor</sub></sub> = 109 dB and CL<sub>X-ile<sub>BaseVictim</sub></sub> = 112 dB. Therefore, P<sub>ACLR</sub> = (109 – 112) + (115 – 112) = 0 dB.

The final ACLR as reference by the victim’s bandwidth is hence:

$$ACLR = Y + X - F_{ACLR} + P_{ACLR}$$

5.1.1.4.2 Uplink Asymmetrical Bandwidths ACIR (Aggressor with smaller bandwidth)

Consider the scenario in Figure 5.4, the interference experienced by UE1 is affected by 25% ACLR of  $30 + X - F_{ACLR}$  and 75% ACLR of  $43 + X - F_{ACLR}$ . Since the victim bandwidth is larger than the aggressor, the interference experienced by UE1 will be caused by a mixture of ACLR  $30 + X - F_{ACLR}$  and ACLR  $43 + X - F_{ACLR}$ . For victim UE2 and UE3, the interference is caused by ACLR  $43 + X - F_{ACLR}$ . The effective interference onto UE1 is dependent upon the aggressor and victim bandwidths. If we take this level of interference and assumed that it is caused by an aggressor of the same bandwidth (i.e. normalising the ACLR to the victim bandwidth) we have the normalised ACLR in Table 5.2C.

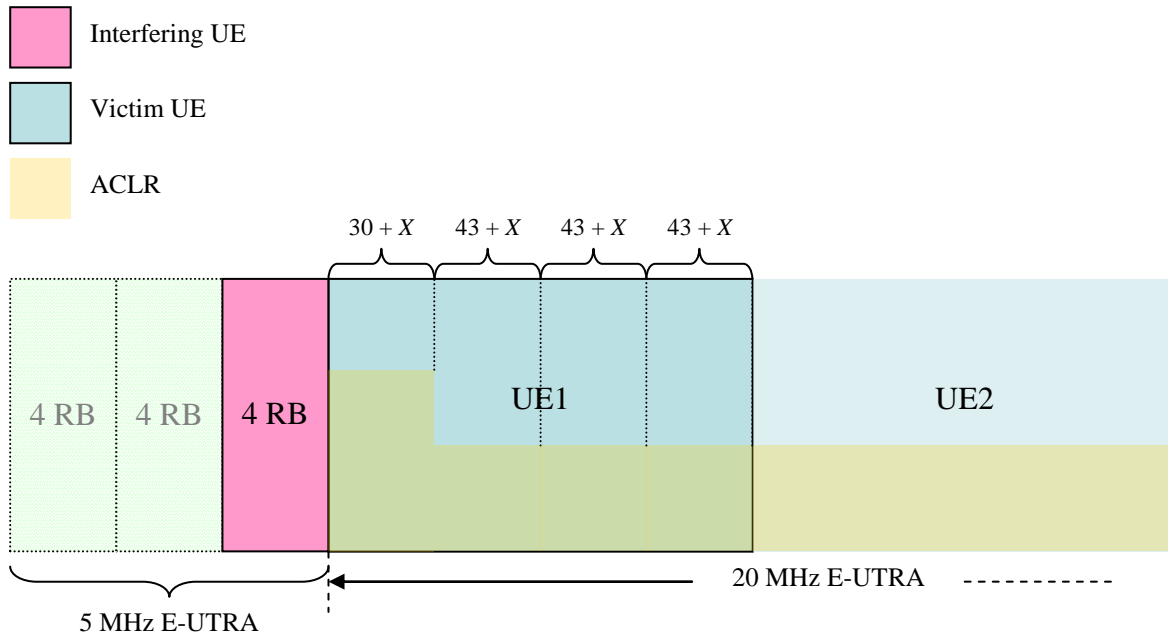

Figure 5.4: 5 MHz E-UTRA aggressor to 20 MHz E-UTRA victim

Table 5.2.C: Value Y (normalised ACLR =  $Y + X - F_{ACLR}$ ) for victim UE1

Aggressor Bandwidth (MHz)	Victim: Value Y (dB): ACLR = $(Y + X - F_{ACLR})$ measured over $B_{Victim}$			
	20 MHz	15 MHz	10 MHz	5 MHz
15 MHz	29.93	-	-	-
10 MHz	29.79	29.89	-	-
5 MHz	29.39	29.59	29.79	-
1.6 MHz	28.02	28.48	28.99	29.56

The ACLR of the aggressor is likely to be larger than  $43 + X$  dB after the 2nd ACLR and hence it is reasonable to assume that the Y value of the normalised ACLR in Table 5.2C onto victim UE1 is close to 30 dB. This is similar to the symmetrical bandwidth coexistence scenario where the first UE is affected by an ACLR of  $30 + X$  dB. For victim UE2 and UE3, the ACLR  $43 + X$  is unrealistic. For scenario where the aggressor bandwidth is much smaller than the victim bandwidth, the ACLR into UE2 and UE3 is going to be much larger than  $43 + X$ . For example for 1.6 MHz E-UTRA aggressor and 20 MHz E-UTRA victim, the interference into UE2 and UE3 is caused by the 13th ACLR (of 1.6 MHz aggressor) and above and this will likely be lower than the noise floor of the victim UE. Hence, the interference experienced by UE2 and UE3 from an aggressor with a smaller bandwidth will not be worse than that from an aggressor with a symmetrical bandwidth. Therefore, the ACLR value for coexistence between E-UTRA systems with symmetrical bandwidth is sufficient for coexistence where the aggressor bandwidth is smaller than that of the victim.

5.1.1.4 Frequency re-use and interference mitigation schemes for E-UTRA

For initial simulations, 1/1 frequency re-use shall be used.

### 5.1.1.5 CQI estimation

It is assumed that the CQI including external system interference is available before the scheduling process. This assumption is valid for the victim system only.

### 5.1.1.6 Power control modelling for E-UTRA and 3.84 Mcps TDD UTRA

No power control in downlink, fixed power per frequency resource block is assumed.

The following power control equation shall be used for the initial uplink (for E-UTRA and 3.84 Mcps TDD UTRA employing Enhanced UL) coexistence simulations:

$$P_t = P_{\max} \times \min \left\{ 1, \max \left[ R_{\min}, \left( \frac{CL}{CL_{x-ile}} \right)^\gamma \right] \right\}$$

where  $P_{\max}$  is the maximum transmit power,  $R_{\min}$  is the minimum power reduction ratio to prevent UEs with good channels to transmit at very low power level,  $CL$  is the path coupling loss defined as  $\max\{\text{path loss}-G_{TX}-G_{RX}, \text{MCL}\}$ , where path loss is propagation loss plus shadowfading,  $G_{TX}$  is the transmitter antenna gain in the direction of the receiver,  $G_{RX}$  is the receiver antenna gain in the direction of the transmitter and  $CL_{x-ile}$  is the  $x$ -percentile  $CL$  value. With this power control equation, the  $x$  percent of UEs that have the highest coupling loss will transmit at  $P_{\max}$ . Finally,  $0 < \gamma \leq 1$  is the balancing factor for UEs with bad channel and UEs with good channel:

The parameter sets for power control are specified in table 5.3.

**Table 5.3: Power control algorithm parameter**

Parameter set	Gamma	CL <sub>x-ile</sub>			
		20 MHz bandwidth	15 MHz bandwidth	10 MHz bandwidth	5 MHz bandwidth
Set 1	1	109	110	112	115
Set 2	0,8	TBD	TBD	129	133

Further discussion and alignment concerning power control algorithms may be required after initial simulation results and further inputs from RAN WG1 are available

### 5.1.1.7 SIR target requirements for simulated services

For E-UTRA, shifted and truncated Shannon bound curves as specified in Annex A.1 shall be used.

In the downlink, UTRA 3.84 Mcps TDD shall use HSDPA since most 3.84 Mcps TDD deployments service data traffic. A shifted and truncated Shannon bound curves described in Annex A.3 shall be used.

In the uplink, UTRA 3.84 Mcps TDD shall use Enhanced UL with data traffic. The shifted and truncated Shannon bound curve used for E-UTRA uplink in Annex A.1 shall be used.

For E-UTRA TDD (LCR TDD frame structure based) shifted and truncated Shannon bound curves as specified in Annex A.4 shall be used.

### 5.1.1.8 Number of required snapshots

The number of snapshots shall be chosen such to obtain sufficient statistical property of the results.

### 5.1.1.9 Simulation output

Simulation results for E-UTRA as victim shall be presented in terms of throughput reduction in percent relative to the reference throughput without external interference vs. ACIR, separately for all UE and for the 5% throughput CDF UE.

All the generated statistics (e.g. bitrates) are instantaneous distributions on sub frame basis, not on a per-session basis. I.e. the instantaneous bit rates need to be averaged in order to obtain the session average UE throughput.

Simulation results for UTRA FDD as victim shall be presented in terms of capacity reduction vs. ACIR. Capacity is defined by the number of satisfied speech users.

Simulation results for UTRA 3,84 Mcps TDD as victim shall be presented in terms of throughput reduction in percent relative to the reference throughput without external interference vs. ACIR

## 5.1.2 Simulation description

Uplink and Downlink are simulated independently. Degradation of victim system will be obtained by comparing capacity/throughput simulation results of single operator scenario (without external interference) to the multi operator case.

In the following sections the principle downlink simulation flows are described, taking the current simulation assumptions into account.

For TDD simulations, both TDD networks (aggressor and victim) are synchronised together and have a common downlink/uplink resource allocation.

### 5.1.2.1 Downlink E-UTRA interferer UTRA victim

1. Run UTRA snapshot simulator procedure [3]. E-UTRA BS TX power is set to the defined maximum TX power (assumes all RB in use). All E-UTRA base stations are considered as a source of other system interference (I<sub>other</sub>). I<sub>other</sub> = sum over all other system cells (interference power into UTRA bandwidth including ACIR)
2. Collect statistics.

The UTRA 3.84 Mcps TDD victim are synchronised and uses HSDPA service. The simulation procedure shall be the same as that in Section 5.1.2.2 (Downlink E-UTRA interferer E-UTRA victim). Here, the CQI value in Step 2 (of Section 5.1.2.2) shall be calculated based on per resource unit (timeslot × code) instead of per resource block.

### 5.1.2.2 Downlink E-UTRA interferer E-UTRA victim

For  $i=1:\#$  of snapshots

1. Distribute terminals randomly throughout the system area such that to each cell within the HO margin of 3 dB the same number  $K$  of users is allocated.
2. Calculate DL CQI for each UE. The CQI value per resource block is equal to  $C(RB)/I(RB)$ , where:
  - $C(RB) = \text{power of resource block} * \max(\text{pathloss-G}_{Tx}\text{-G}_{Rx}, \text{MCL})$
  - $I(RB) = \text{sum over all other cells} (\text{power of resource block} * \max(\text{pathloss-G}_{Tx}\text{-G}_{Rx}, \text{MCL})) + \text{sum over all other system cells} (\text{interference power into this resource block including ACIR}) + N$
  - Note: in case of the 5 MHz and 10 MHz E-UTRA victim case, the BS ACLR (ACIR) is modelled as flat, i.e. the same ACIR is used for all RB.
3. Perform PS operation for all cells:
  - Loop over all cells
    - Loop over all UE attached to the cell
      - Select the next UE to be scheduled based on the scheduling metric (i.e. randomly for Round Robin).
4. Calculate actual intra/inter system interference to get the actual C/I and bit rates for each UE.
  - Use the actual C/I to throughput mapping (Annex A) to determine the obtained throughput for the UE.
  - Note: the actual C/I value of a scheduled RB is equal to the CQI value calculated in step 2.
5. Collect statistics.



### 5.1.2.3 Uplink E-UTRA interferer UTRA victim

For  $i=1:\#$  of snapshots

1. Distribute terminals randomly throughout the system area such that to each cell within the HO margin of 3 dB the same number  $K$  of users is allocated.
2. Perform PS operation for all cells:
  - Loop over all cells
    - Loop over all UEs attached to the cell
      - Select the next UE to be scheduled based on the scheduling metric (i.e. randomly for Round Robin)
      - Pick 4 RB among the “not scheduled” ones and mark it as “scheduled”
      - Set UE transmit power to  $P_t = P_{\max} \times \min \left\{ 1, \max \left[ R_{\min}, \left( \frac{CL}{CL_{x-ile}} \right)^\gamma \right] \right\}$
3. Run UTRA snapshot simulator procedure [3]. All E-UTRA terminals are considered as a source of other system interference ( $I_{\text{other}}$ ).  $I_{\text{other}}$  = sum over all other system terminals (interference power into UTRA bandwidth including ACIR).
4. Collect statistics.

For UTRA 3.84 Mcps TDD victim using Enhanced Uplink, the system TDD victim shall be synchronised and simulation procedure shall be the same as that in Section 5.1.2.4 (Uplink E-UTRA interferer E-UTRA victim).

### 5.1.2.4 Uplink E-UTRA interferer E-UTRA victim

For  $i=1:\#$  of snapshots

1. Distribute terminals randomly throughout the system area such that to each cell within the HO margin of 3 dB the same number  $K$  of users is allocated.
2. Perform PS operation for all cells:
  - Loop over all cells
    - Loop over all UE attached to the cell
      - Select the next UE to be scheduled based on the scheduling metric (i.e. randomly for Round Robin)
      - Pick 8 RB among the “not scheduled” ones and mark it as “scheduled”
      - Set UE transmit power to  $P_t = P_{\max} \times \min \left\{ 1, \max \left[ R_{\min}, \left( \frac{CL}{CL_{x-ile}} \right)^\gamma \right] \right\}$
3. Calculate actual intra/inter system interference to get the actual  $C/(I+N)$  and bit rates for each UE.
  - Use the actual  $C/(I+N)$  to throughput mapping as specified in Annex A to determine the obtained throughput for the UE.
4. Collect statistics.

## 6 System scenarios

This chapter contains the system scenarios defined based upon the models described above designed for the interference studies, RRM studies etc

### 6.1 Co-existence scenarios

Table 6.1 summarizes the proposed initial simulation scenarios. This list is tentative and represents the actual status of the discussion. The list will be reviewed when the work on the simulation scenarios progresses. Uncoordinated deployment is assumed for all these simulation scenarios.

**Table 6.1; Summary of simulation scenarios**

Aggressor system	Victim system	Simulation frequency	Environment	Cell Range	Priority
10 MHz E-UTRA	10 MHz E-UTRA	2000 MHz	Urban Area	500 m	high
5 MHz E-UTRA	20 MHz E-UTRA	2000 MHz	Urban Area	500 m	lower
5 MHz E-UTRA	UTRA	2000 MHz	Urban Area	500 m	high
[1.25] MHz E-UTRA	GERAN	900 MHz	Rural Area	2000 m	lower
20 MHz E-UTRA	UTRA	2000 MHz	Urban Area	500 m	lower
1.6 MHz E-UTRA	UTRA 1.6MHz	2000 MHz	Urban Area	500 m	high

For high priority simulation scenarios, it was decided to simulate scenarios with the following priority:

- 5MHz E-UTRA – UTRA (victim), downlink
- 10MHz E-UTRA – 10MHz E-UTRA (victim), downlink
- 10MHz E-UTRA – 10MHz E-UTRA (victim), uplink
- 5MHz E-UTRA – UTRA (victim), uplink
- 1.6MHz E-UTRA –UTRA 1.6MHz (victim), downlink
- 1.6MHz E-UTRA –UTRA 1.6MHz (victim), uplink

## 7 Results

### 7.1 Radio reception and transmission

#### 7.1.1 FDD coexistence simulation results

##### 7.1.1.1 ACIR downlink 5MHz E-UTRA interferer – UTRA victim

Simulations are based on the following assumptions:

- Aggressor system: 5 MHz E-UTRA
- Victim system: UTRA FDD
- Simulation frequency: 2000 MHz
- Environment: Macro Cell, Urban Area, uncoordinated deployment

Cell Range 500 m

Simulation results are presented in table 7.1 and figure 7.1.

**Table 7.1: UTRA FDD downlink capacity loss**

ACIR (dB)	Nokia (R4-060375)	Siemens (R4-060379)	Huawei (R4-060448)	Motorola (R4-060461)	Ericsson (R4-060592)	Lucent (R4-061134)	DoCoMo (R4-060967)	Qualcomm (R4-070036)	average
25	7,5 %	11,30 %	4,78 %	17,5 %	8 %	6,7 %	12,6 %	10,18 %	9,82 %
30	3,2 %	5,40 %	1,43 %	7 %	3 %	2,3 %	5,7 %	3,84 %	3,98 %
35	1,8 %	2,51 %	0,16 %	2,5 %	1,2 %	0,7 %	2,2 %	1,31 %	1,55 %
40	0,8 %	1,07 %	0,08 %	1 %	0,5 %	0,1 %	0,7 %	0,39 %	0,58 %
45	0,5 %		0 %	0,5 %	0,4 %				0,35 %

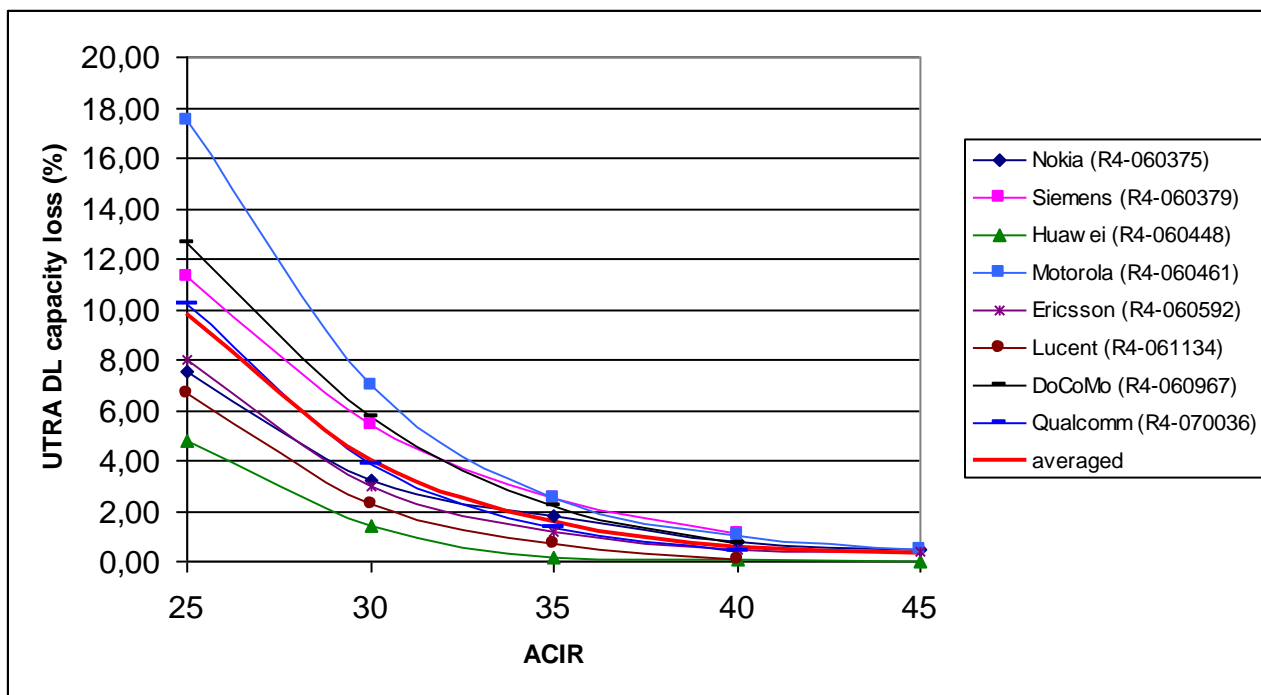

**Figure 7.1: UTRA FDD capacity loss**

**7.1.1.2 ACIR downlink 10MHz E-UTRA interferer – 10MHz E-UTRA victim**

Simulations are based on the following assumptions:

- Aggressor system: 10 MHz E-UTRA
- Victim system: 10 MHz E-UTRA
- Simulation frequency: 2000 MHz
- Environment: Macro Cell, Urban Area, uncoordinated deployment
- Cell Range 500 m

Simulation results for average E-UTRA downlink throughput loss are presented in table 7.2 and figure 7.2. Simulation results for 5% CDF throughput E-UTRA throughput loss are presented in table 7.3 and figure 7.3.

Table 7.2: Average E-UTRA downlink throughput loss

ACIR (dB)	Siemens (R4-060748)	Huawei (R4-061003)	Motorola (R4-060462)	Ericsson (R4-061071)	DoCoMo (R4-060967)	Lucent (R4-061134)	Qualcomm (R4-061342)	averaged
15	12,29 %	12,63 %		12,56 %		13,67 %		12,79 %
20	6,31 %	6,51 %	7 %	6,66 %	6,6 %	7,32 %	6,50 %	6,73 %
25	3,1 %	3,17 %	3,5 %	3,28 %	3,2 %	3,65 %	3,10 %	3,32 %
30	1,51 %	1,34 %	1,5 %	1,49 %	1,4 %	1,68 %	1,40 %	1,49 %
35	0,67 %	0,46 %	0,5 %	0,62 %	0,6 %	0,7 %	0,50 %	0,59 %
40	0,30 %	0,11 %	0,25 %	0,24 %	0,2 %	0,25 %	0,20 %	0,23 %
45	0,11 %		0,1 %	0,08 %		0,07 %		0,09 %
50	0,03 %		0 %	0,03 %		0 %		0,02 %

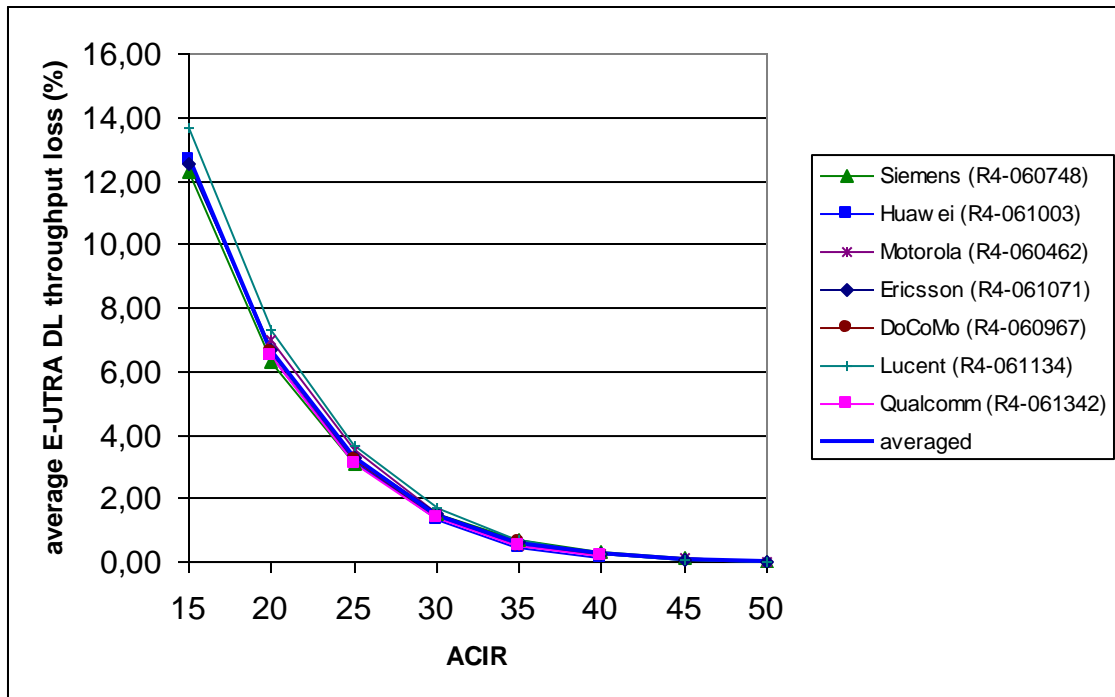

Figure 7.2: average E-UTRA downlink throughput loss

Table 7.3: 5% CDF E-UTRA downlink throughput loss

ACIR (dB)	Siemens (R4-060749)	Huawei (R4-061003)	Motorola	Ericsson (R4-061071)	DoCoMo (R4-060967)	Lucent (R4-061134)	Qualcomm (R4-061342)	(5% CDF) averaged
15	58,3 %	100 %		58,61 %		99,99 %		79,23 %
20	35,08 %	66,86 %	22,64 %	30,91 %	28,3 %	36,75 %	27,50 %	36,76 %
25	20,15 %	17,76 %	2,52 %	14,14 %	13,4 %	17,41 %	13,00 %	14,23 %
30	11,62 %	6,18 %	0,84 %	6,11 %	5,8 %	7,03 %	5,60 %	6,26 %
35	5,56 %	2,64 %	0,28 %	2,24 %	2,4 %	2,57 %	2,10 %	2,62 %
40	1,92 %	2,24 %	0,01 %	0,95 %	0,8 %	0,78 %	0,70 %	1,12 %
45	0,53 %			0,23 %		0,27 %		0,34 %
50	0,12 %			0,07 %		0 %		0,06 %

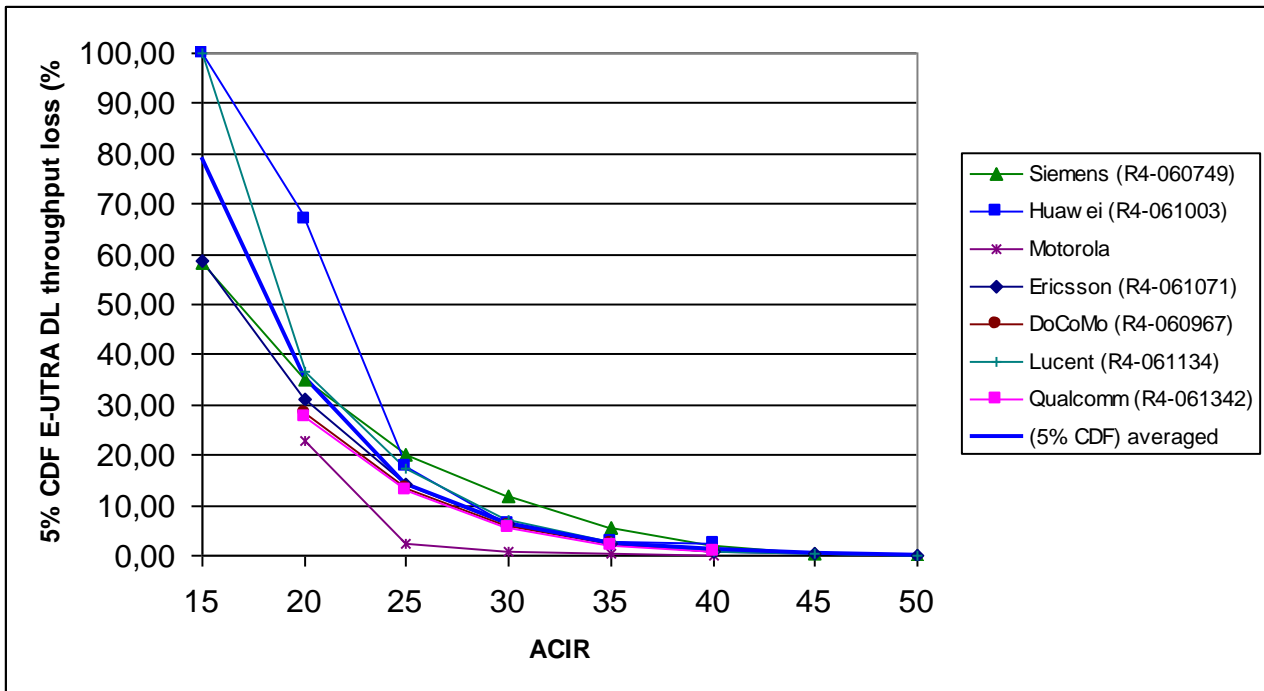

Figure 7.3: 5% CDF E-UTRA downlink throughput loss

7.1.1.3 ACIR uplink 5MHz E-UTRA interferer – UTRA victim

Simulations are based on the following assumptions:

- Aggressor system: 5 MHz E-UTRA
- Victim system: UTRA FDD
- Simulation frequency: 2000 MHz
- Environment: Macro Cell, Urban Area, uncoordinated deployment
- Cell Range 500 m

Simulation results are presented in table 7.3a and figure 7.3a for power control parameter set 1 and in table 7.3b and figure 7.3b for E-UTRA power control parameter set 2 respectively. E-UTRA power control parameter sets are specified in section 5.1.1.6.

Table 7.3a: UTRA FDD uplink capacity loss for E-UTRA power control set 1

ACIR offset (dB)	NTT DoCoMo (R4-061145)	Motorola (R4-061230)	Ericsson (R4-061319)	Panasonic (R4-061197)	Siemens (R4-061303)	Qualcomm (R4-070036)	Alcatel-Lucent (R4-070096)	Nokia (R4-070235)	PC set 1 averaged
-15									
-10								100 %	100 %
-5		75,80 %	100,00 %		78,90 %		100,00 %	82,00 %	87,34 %
0	39,50 %	20,30 %	42,90 %	17,50 %	35,29 %	49,00 %	45,30 %	29,00 %	34,85 %
5	12,60 %	5,90 %	13,60 %	6,60 %	12,37 %	14,20 %	14,40 %	13,00 %	11,58 %
10	3,3 %	2 %	4,3 %	1,1 %	3,35 %	4,9 %	4,4 %	6,0 %	3,67 %
15			1,4 %		1,11 %	1,8 %	1,3 %	3,0 %	1,72 %
20					0,32 %		0,4 %		0,36 %

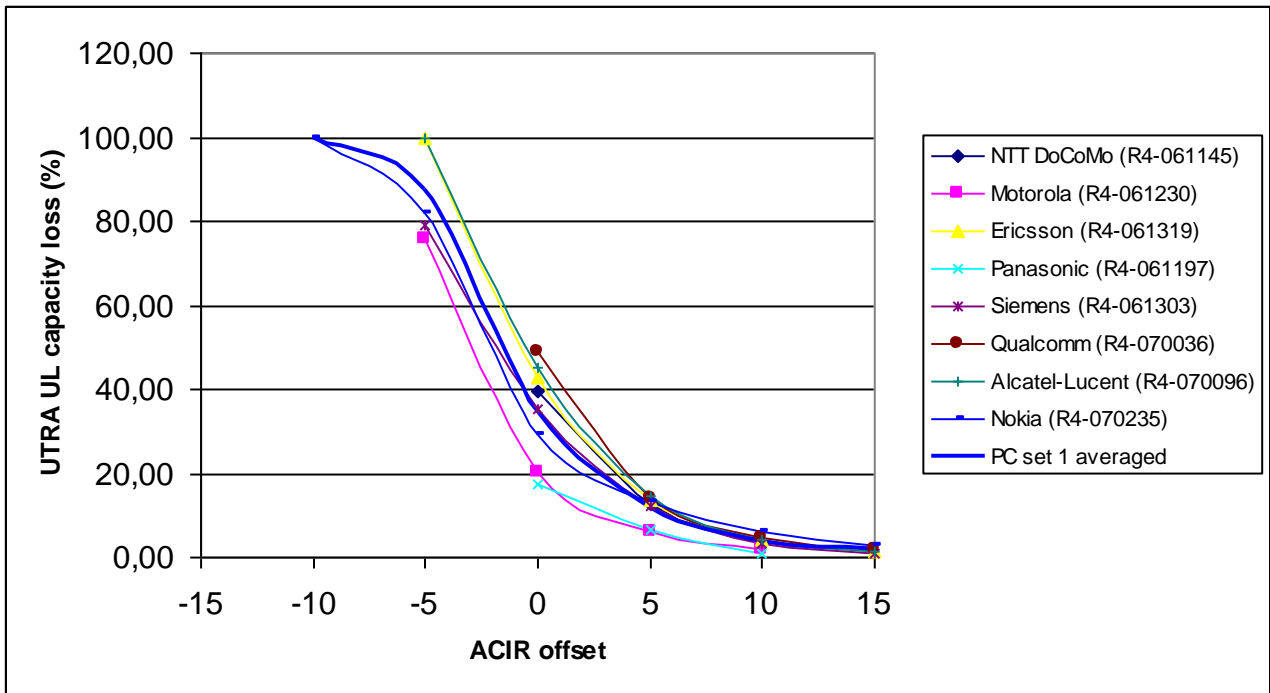

Figure 7.3a: UTRA FDD uplink capacity loss for E-UTRA power control set 1

Table 7.3b: UTRA FDD uplink capacity loss for E-UTRA power control set 2

ACIR offset (dB)	NTT DoCoMo (R4-061145)	Motorola (R4-061230)	Ericsson (R4-061319)	Panasonic (R4-061197)	Siemens (R4-061303)	Qualcomm (R4-070036)	Alcatel-Lucent (R4-070096)	Nokia (R4-070235)	PC set 2 averaged
-15			100,00 %				89,10 %	57,00 %	82,03 %
-10	22,90 %	13,90 %	34,30 %	21,50 %	23,11 %	30,90 %	34,80 %	20,00 %	25,18 %
-5	7,50 %	4,40 %	10,90 %	5,20 %	7,46 %	9,80 %	8,80 %	8,00 %	7,76 %
0	2,40 %	1,10 %	3,40 %	1,92 %	2,34 %	3,30 %	3,00 %	4,00 %	2,68 %
5	0,80 %	0,40 %	1,10 %	0,72 %	0,86 %	1,20 %	0,90 %	1,00 %	0,87 %
10	0,3 %		0,3 %	0,21 %	0,27 %		0,2 %	0,3 %	0,26 %
15			0,1 %		0,09 %		0 %	0,2 %	0,10 %
20					0,04 %		0 %		0,02 %

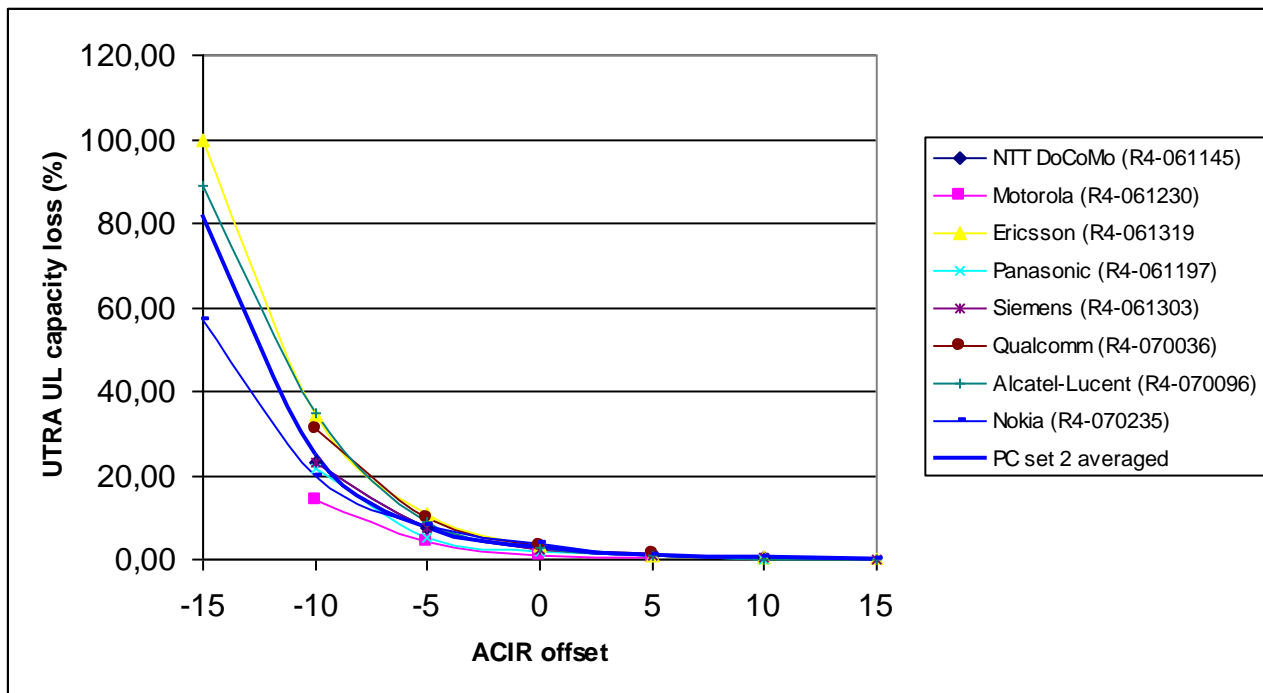

Figure 7.3b: UTRA FDD uplink capacity loss for E-UTRA power control set 2

7.1.1.4 ACIR uplink 10MHz E-UTRA interferer – 10MHz E-UTRA victim

Simulations are based on the following assumptions:

- Aggressor system: 10 MHz E-UTRA
- Victim system: 10 MHz E-UTRA
- Simulation frequency: 2000 MHz
- Environment: Macro Cell, Urban Area, uncoordinated deployment
- Cell Range 500 m

Simulation results for average E-UTRA uplink throughput loss are presented in table 7.3c and figure 7.3c for power control parameter set 1 and in table 7.3d and figure 7.3d for E-UTRA power control parameter set 2 respectively. Simulation results for 5% CDF throughput E-UTRA throughput loss are presented in table 7.3e and figure 7.3e for power control parameter set 1 and in table 7.3f and figure 7.3f for E-UTRA power control parameter set 2 respectively. E-UTRA power control parameter sets are specified in section 5.1.1.6.

Table 7.3c: Average E-UTRA uplink throughput loss for power control set 1

ACIR offset (dB)	NTT DoCoMo (R4-061146)	Motorola (R4-061231)	Siemens (R4-061349)	Ericsson (R4-061319)	Panasonic (R4-061197)	Fujitsu (R4-061259)	Nokia (R4-061306)	Qualcomm (R4-061343)	Alcatel-Lucent (R4-070096)	PC set 1 averaged
-15	19,00 %		18,03 %	18,10 %		18,80 %	16,40 %		17,32 %	17,94 %
-10	10,20 %	9,40 %	9,9 %	9,60 %	11,26 %	10,10 %	9,60 %	10,30 %	9,55 %	9,99 %
-5	5,00 %	4,50 %	4,67 %	4,70 %	5,41 %	4,90 %	5,10 %	5,00 %	4,69 %	4,89 %
0	2,30 %	1,90 %	1,98 %	2,00 %	2,47 %	2,20 %	2,50 %	2,10 %	2,08 %	2,17 %
5	1,00 %	0,80 %	0,66 %	0,80 %	1,02 %	0,90 %	1,10 %	0,90 %	0,84 %	0,89 %
10	0,40 %	0,30 %		0,20 %	0,39 %	0,30 %	0,40 %	0,40 %	0,31 %	0,34 %
15	0,10 %			0,00 %	0,14 %				0,11 %	0,09 %
20					0,05 %				0,04 %	0,05 %

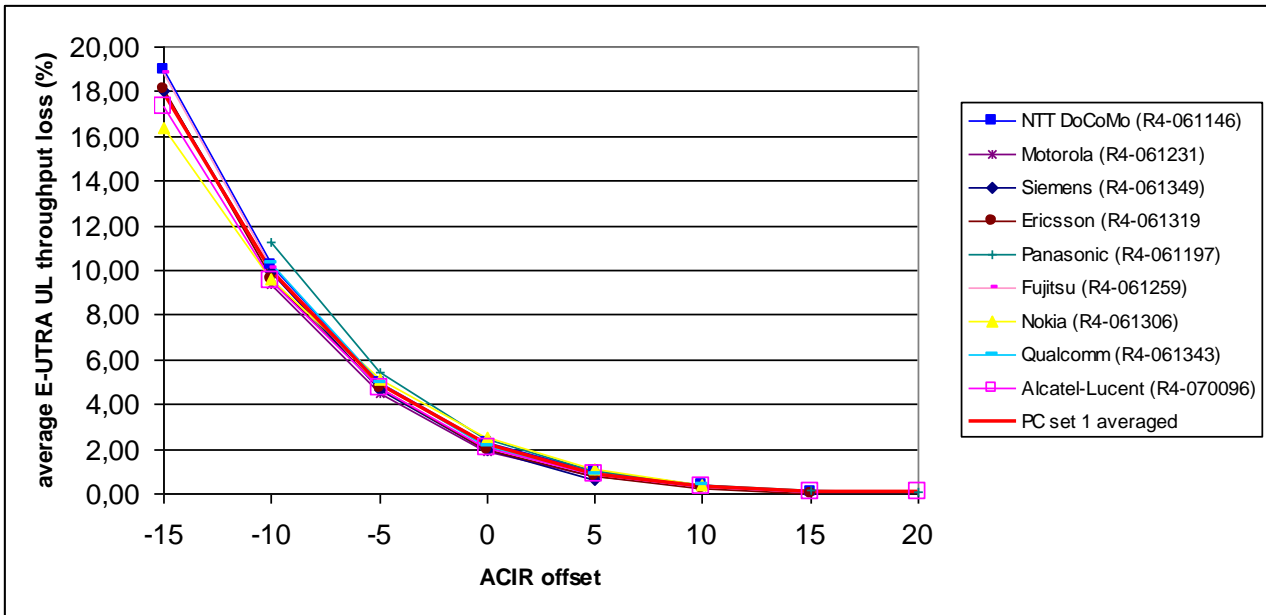

Figure 7.3c: Average E-UTRA uplink throughput loss for power control set 1

Table 7.3d: Average E-UTRA uplink throughput loss for power control set 2

ACIR offset (dB)	NTT DoCoMo (R4-061146)	Motorola (R4-061231)	Siemens (R4-061349)	Ericsson (R4-061319)	Panasonic (R4-061197)	Fujitsu (R4-061259)	Nokia (R4-061306)	Qualcomm (R4-061343)	Alcatel-Lucent (R4-070096)	PC set 2 averaged
-15	14.20 %		12.9 %	12.50 %		15.10 %	11.20 %		13.12 %	13.17 %
-10	7.10 %	6.40 %	6.62 %	6.10 %	7.09 %	7.60 %	6.00 %	7.00 %	6.68 %	6.73 %
-5	3.20 %	2.80 %	2.97 %	2.70 %	3.14 %	3.50 %	2.90 %	3.00 %	3.03 %	3.03 %
0	1.30 %	1.10 %	1.07 %	1.10 %	1.30 %	1.50 %	1.30 %	1.30 %	1.25 %	1.25 %
5	0.50 %	0.50 %	0.11 %	0.40 %	0.49 %	0.60 %	0.60 %	0.50 %	0.47 %	0.46 %
10	0.20 %	0.20 %		0.10 %	0.17 %	0.20 %	0.20 %	0.20 %	0.17 %	0.18 %
15	0.10 %			0.00 %	0.06 %				0.06 %	0.06 %
20					0.02 %				0.02 %	0.02 %

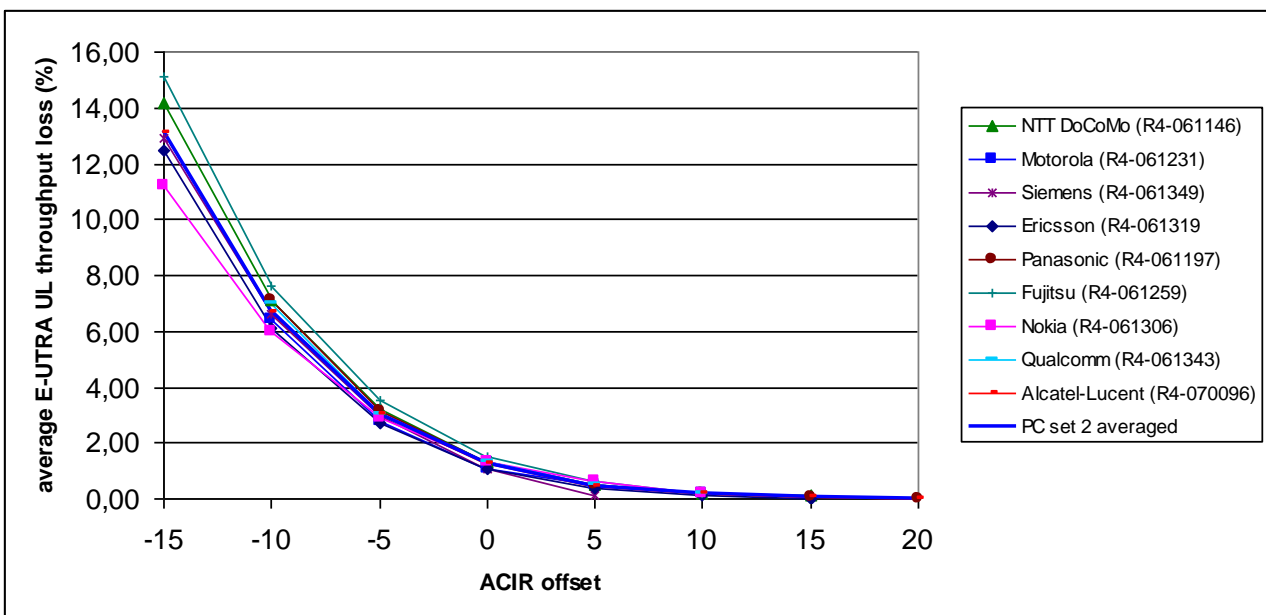

Figure 7.3d: Average E-UTRA uplink throughput loss for power control set 2



Table 7.3e: 5% CDF E-UTRA uplink throughput loss for power control set 1

ACIR offset (dB)	NTT DoCoMo (R4-061146)	Motorola (R4-061231)	Siemens (R4-061349)	Ericsson (R4-061319)	Panasonic (R4-061197)	Fujitsu (R4-061259)	Nokia (R4-061306)	Qualcomm (R4-061343)	Alcatel-Lucent (R4-070096)	PC set 1 (5% CDF) averaged
-15	42,20 %		28,86 %	41,40 %		37,80 %	47,00 %		38,51 %	39,30 %
-10	17,50 %	15,80 %	10,32 %	17,90 %	29,95 %	17,60 %	21,00 %	17,00 %	15,25 %	18,04 %
-5	6,90 %	5,60 %	1,7 %	6,50 %	9,91 %	6,90 %	6,10 %	6,40 %	5,78 %	6,20 %
0	2,00 %	1,10 %	0,11 %	2,80 %	2,58 %	2,10 %	2,20 %	2,10 %	1,80 %	1,87 %
5	0,60 %	0,50 %	0,01 %	1,20 %	0,58 %	0,50 %	0,50 %	0,80 %	0,57 %	0,58 %
10	0,20 %	0,06 %		0,20 %	0,13 %	0,10 %	0,30 %	0,30 %	0,17 %	0,19 %
15	0,10 %			0,00 %	0,03 %				0,04 %	0,04 %
20					0,01 %				0,02 %	0,02 %

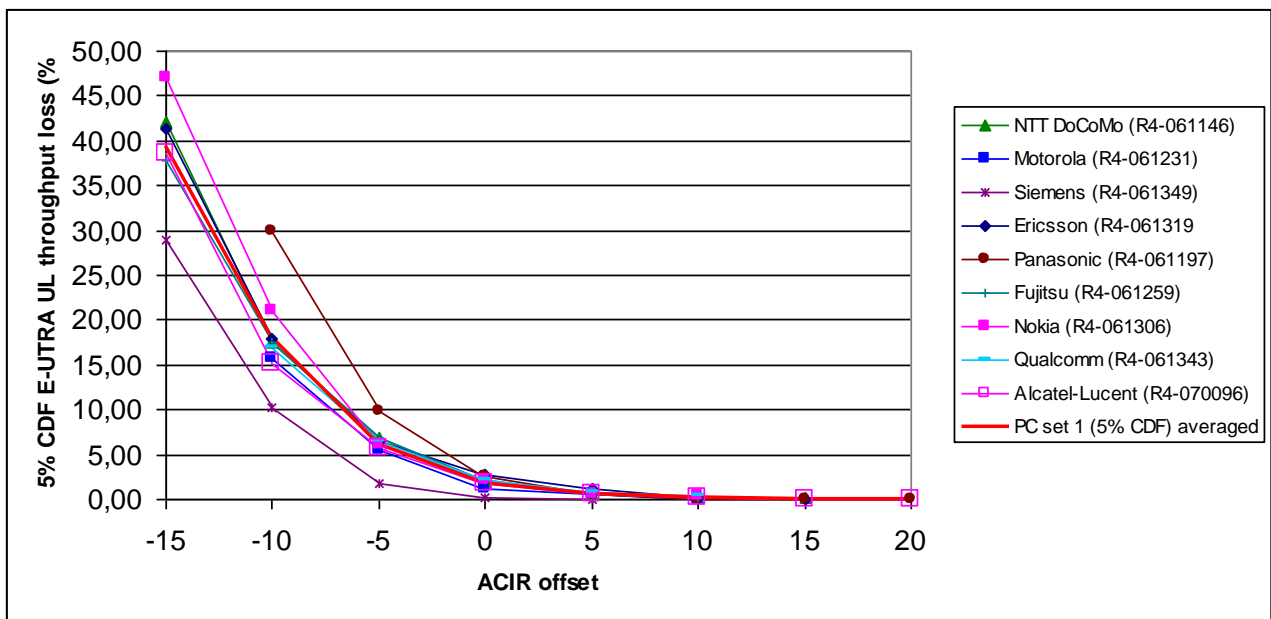

Figure 7.3e: 5% CDF E-UTRA uplink throughput loss for power control set 1

Table 7.3f: 5% CDF E-UTRA uplink throughput loss for power control set 2

ACIR offset (dB)	NTT DoCoMo (R4-061146)	Motorola (R4-061231)	Siemens (R4-061349)	Ericsson (R4-061319)	Panasonic (R4-061197)	Fujitsu (R4-061259)	Nokia (R4-061306)	Qualcomm (R4-061343)	Alcatel-Lucent (R4-070096)	PC set 2 (5% CDF) averaged
-15	34,40 %		34,11 %	30,70 %		32,60 %	29,30 %		29,16 %	31,71 %
-10	15,30 %	11,80 %	17,19 %	13,10 %	18,52 %	14,30 %	13,40 %	15,10 %	12,09 %	14,53 %
-5	5,80 %	4,40 %	5,05 %	4,70 %	5,68 %	5,20 %	7,20 %	5,60 %	4,50 %	5,35 %
0	1,70 %	1,30 %	1,62 %	1,10 %	1,14 %	1,40 %	2,20 %	1,80 %	1,19 %	1,49 %
5	0,70 %	0,40 %	0,08 %	0,40 %	0,24 %	0,30 %	0,50 %	0,60 %	0,40 %	0,40 %
10	0,20 %	0,10 %		0,20 %	0,09 %	0,05 %		0,10 %	0,09 %	0,14 %
15	0,00 %			0,00 %	0,02 %				0,00 %	0,01 %
20					0,01 %				0,00 %	0,01 %

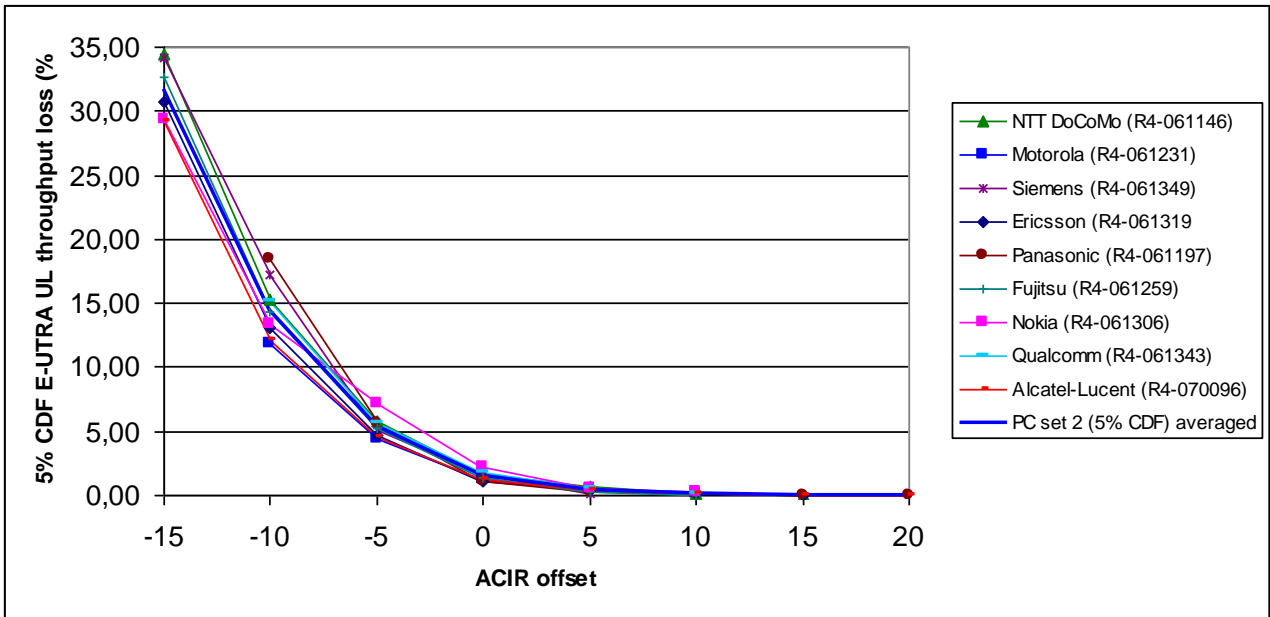

Figure 7.3f: 5% CDF E-UTRA uplink throughput loss for power control set 2

### 7.1.2 TDD coexistence simulation results

#### 7.1.2.1 ACIR downlink 5MHz E-UTRA interferer – UTRA 3.84 Mcps TDD victim

Simulations are based on the following assumptions:

- Aggressor system: 5 MHz E-UTRA
- Victim system: UTRA 3,84 Mcps TDD using HSDPA
- Simulation frequency: 2000 MHz
- Environment: Macro Cell, Urban Area, uncoordinated deployment
- Cell Range 500 m

Simulation results for average UTRA 3,84Mcps TDD downlink throughput loss are presented in table 7.4 and figure 7.4. Simulation results for 5% CDF UTRA 3,84Mcps TDD downlink throughput loss are presented in table 7.5 and figure 7.5.

Table 7.4: average UTRA 3,84Mcps TDD downlink throughput loss

ACIR (dB)	IP Wireless (R4-060813)	Ericsson (R4-061071)
15		12,56 %
20		6,66 %
25	5,2 %	3,28 %
30	2,8 %	1,49 %
35	1,3 %	0,62 %
40	0,7 %	0,24 %
45	0 %	0,08 %
50		0,03 %

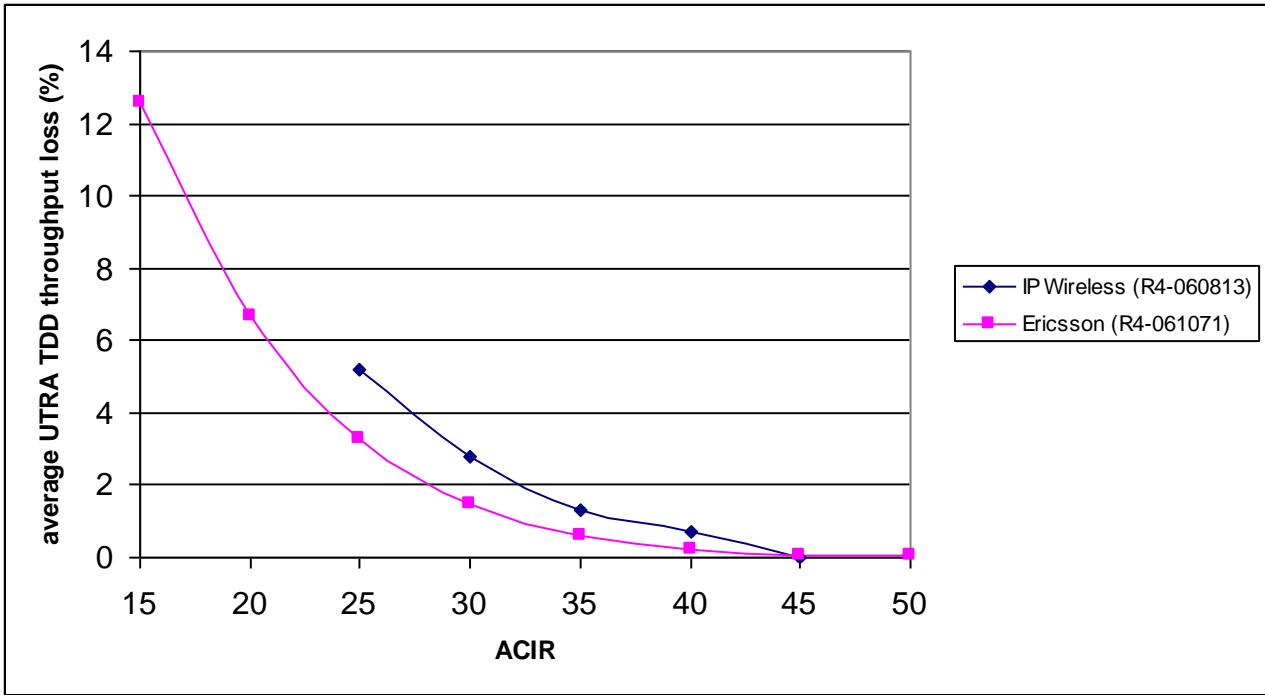

Figure 7.4: average UTRA 3,84Mcps TDD downlink throughput loss

Table 7.5: 5% CDF UTRA 3,84Mcps TDD downlink throughput loss

ACIR (dB)	IP Wireless (R4-060813)	Ericsson (R4-061071)
15		58,61 %
20		30,91 %
25	20,3 %	14,14 %
30	10,8 %	6,11 %
35	5,4 %	2,24 %
40	2,6 %	0,95 %
45	0,85 %	0,23 %
50		0,07 %

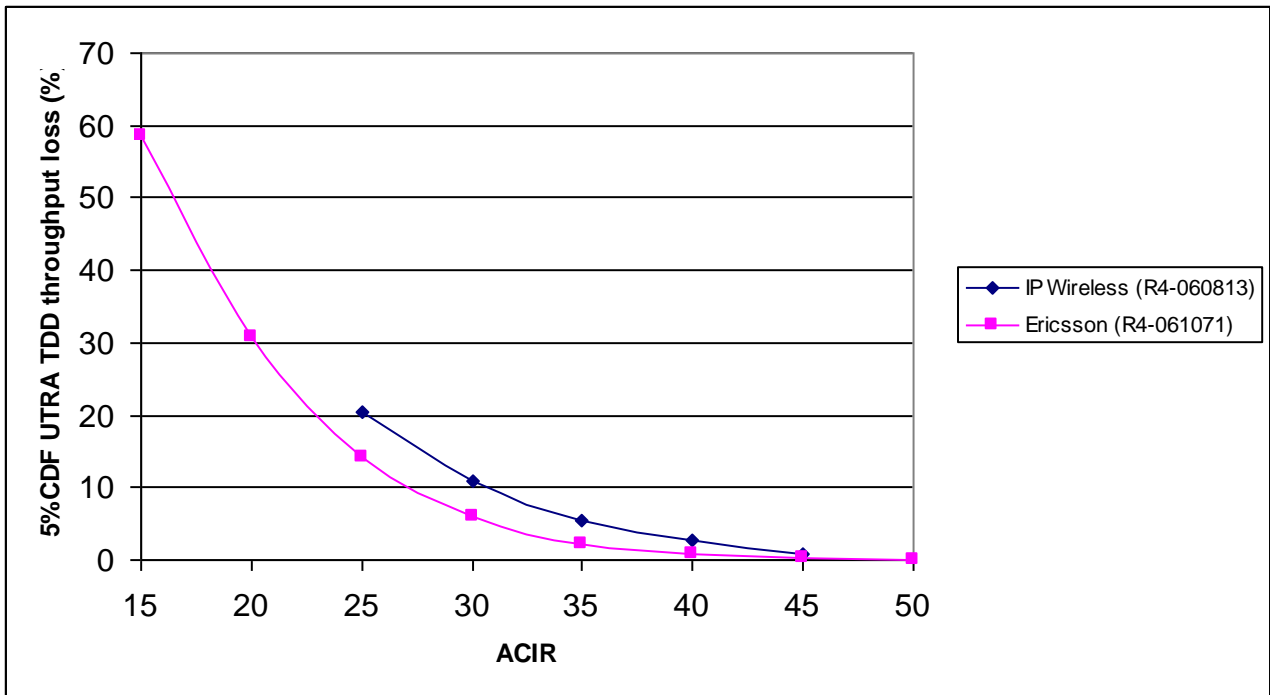

Figure 7.5: 5% CDF UTRA 3,84Mcps TDD downlink throughput loss

7.1.2.2 ACIR downlink 10MHz E-UTRA interferer – 10MHz E-UTRA TDD victim

Simulations are based on the following assumptions:

- Aggressor system: 10 MHz E-UTRA
- Victim system: 10 MHz E-UTRA
- Simulation frequency: 2000 MHz
- Environment: Macro Cell, Urban Area, uncoordinated deployment
- Cell Range 500 m

Simulation results for average E-UTRA TDD downlink throughput loss are presented in table 7.6 and figure 7.6. Simulation results for 5% CDF E-UTRA TDD downlink throughput loss are presented in table 7.7 and figure 7.7.

Table 7.6: average E-UTRA TDD downlink throughput loss

ACIR (dB)	IP Wireless (R4-060813)	Ericsson (R4-061071)
15		12,56 %
20		6,66 %
25	5,3 %	3,28 %
30	2,8 %	1,49 %
35	1,4 %	0,62 %
40	0,7 %	0,24 %
45	0,2 %	0,08 %
50		0,03 %

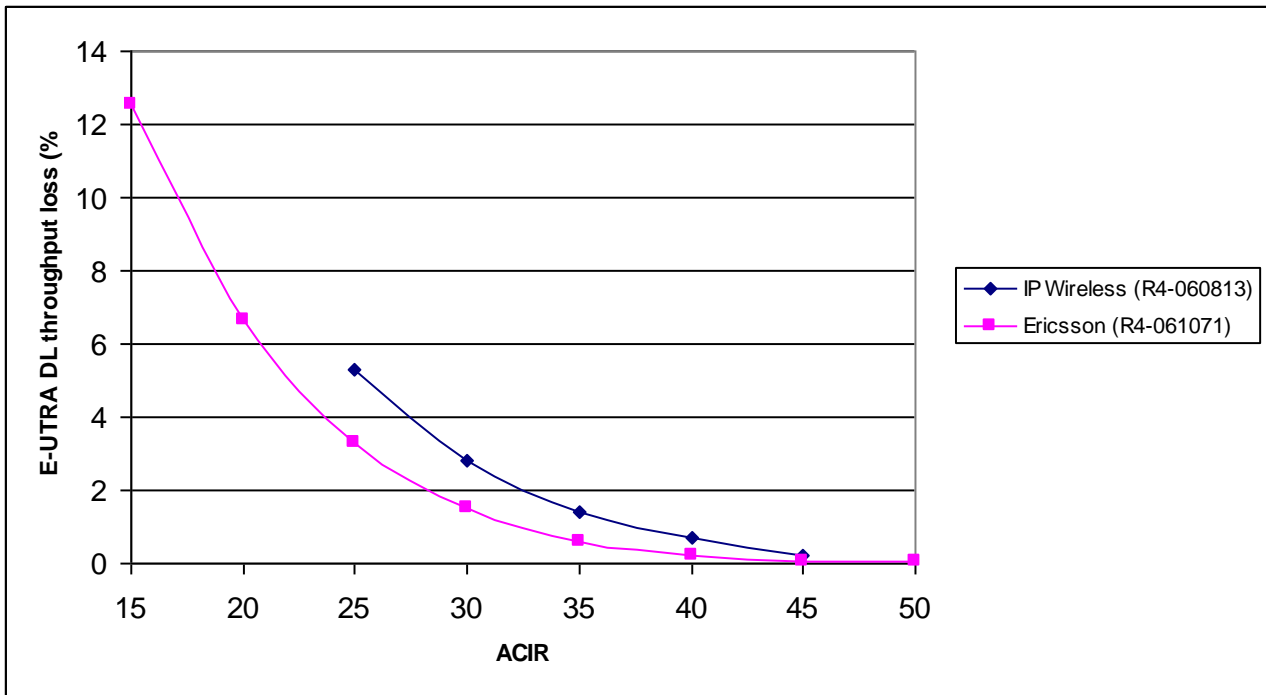

Figure 7.6: average E-UTRA TDD downlink throughput loss

Table 7.7: 5% CDF E-UTRA TDD downlink throughput loss

ACIR (dB)	IP Wireless (R4-060813)	Ericsson (R4-060880)
15		58,61 %
20		30,91 %
25	20,3 %	14,14 %
30	10,8 %	6,11 %
35	5,4 %	2,24 %
40	2,6 %	0,95 %
45	0,85 %	0,23 %
50		0,07 %

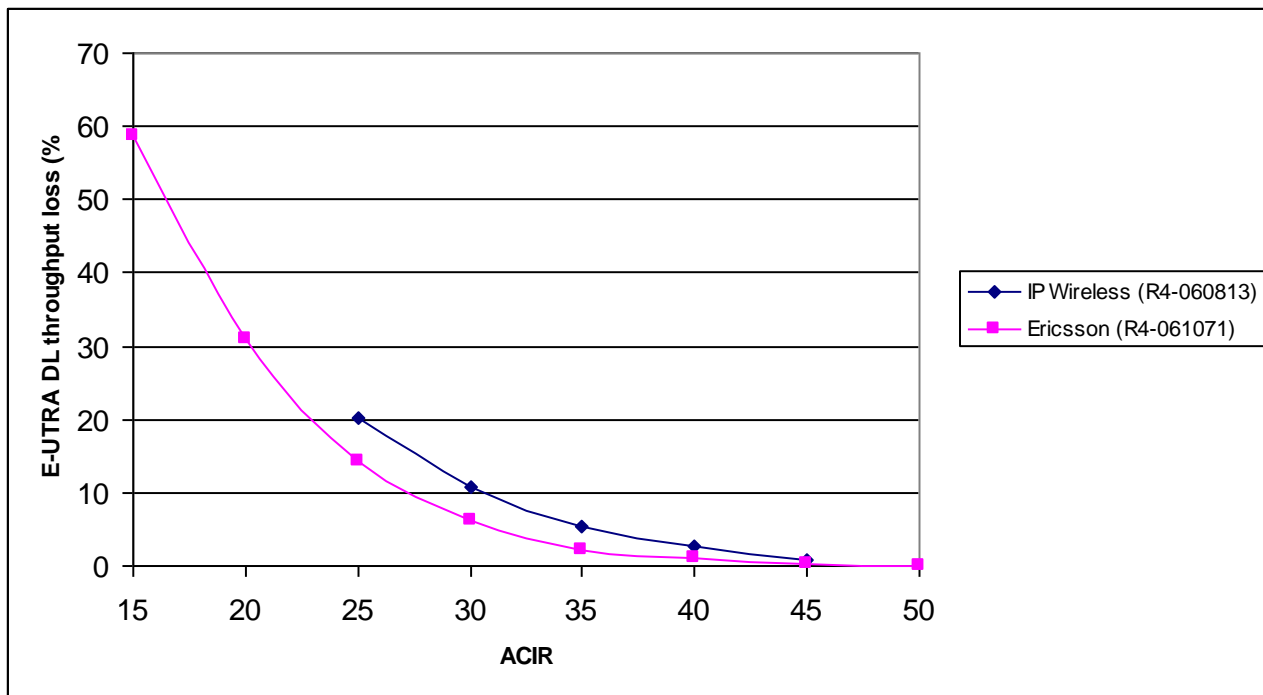

Figure 7.7: 5% CDF E-UTRA TDD downlink throughput loss

7.1.2.3 ACIR downlink 1.6 MHz E-UTRA interferer – UTRA 1.28 Mcps TDD victim

Simulations are based on the following assumptions:

- Aggressor system: 1.6 MHz E-UTRA (LCR TDD frame structure based) using 4 RB, BS output power 35dBm and 43dBm
- Victim system: UTRA 1.28 Mcps TDD using smart antennas as specified in Annex B
- Simulation frequency: 2000 MHz
- Environment: Macro Cell, Urban Area, coordinated and uncoordinated deployment
- Cell Range 500 m

Simulation results are presented in figure 7.8, figure 7.8a, figure 7.9 and figure 7.9a. Co-existence requirements derived from these results require smart antennas at the UTRA 1.28 Mcps TDD system.

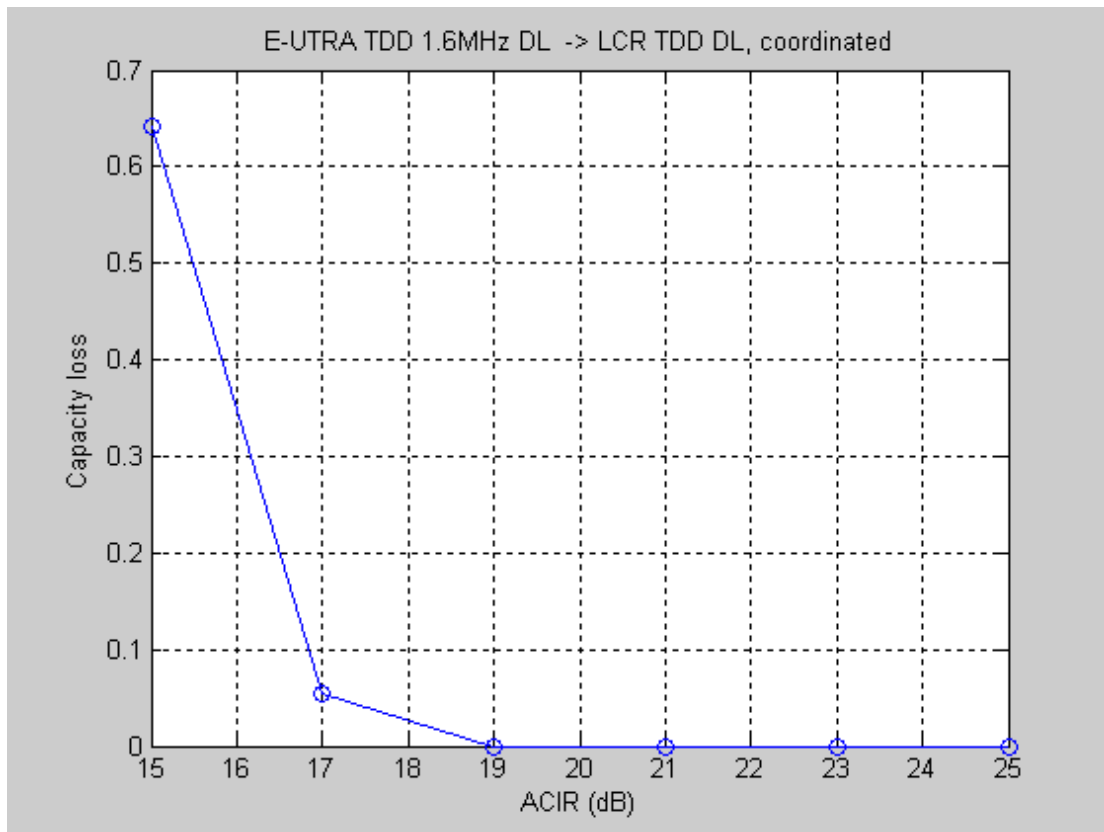

Figure 7.8: Capacity loss of UTRA 1.28 Mcps TDD DL with 1.6MHz E-UTRA DL aggressor, 35dBm BS output power, coordinated deployment

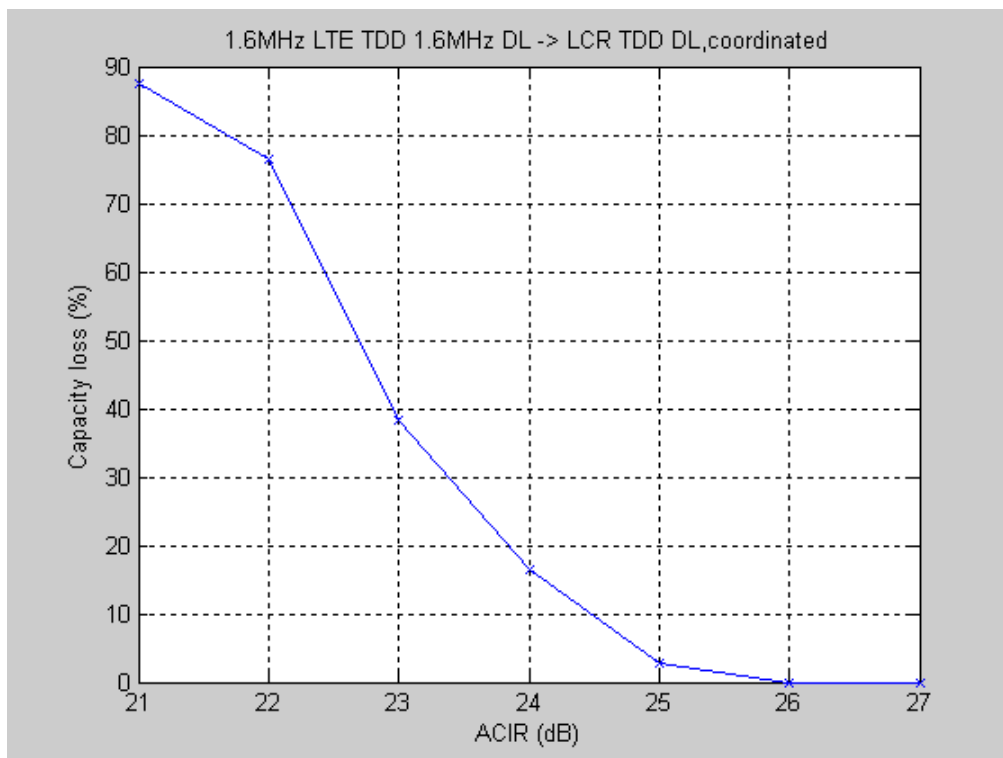

Figure 7.8a: Capacity loss of UTRA 1.28 Mcps TDD DL with 1.6MHz E-UTRA DL aggressor, 43dBm BS output power, coordinated deployment

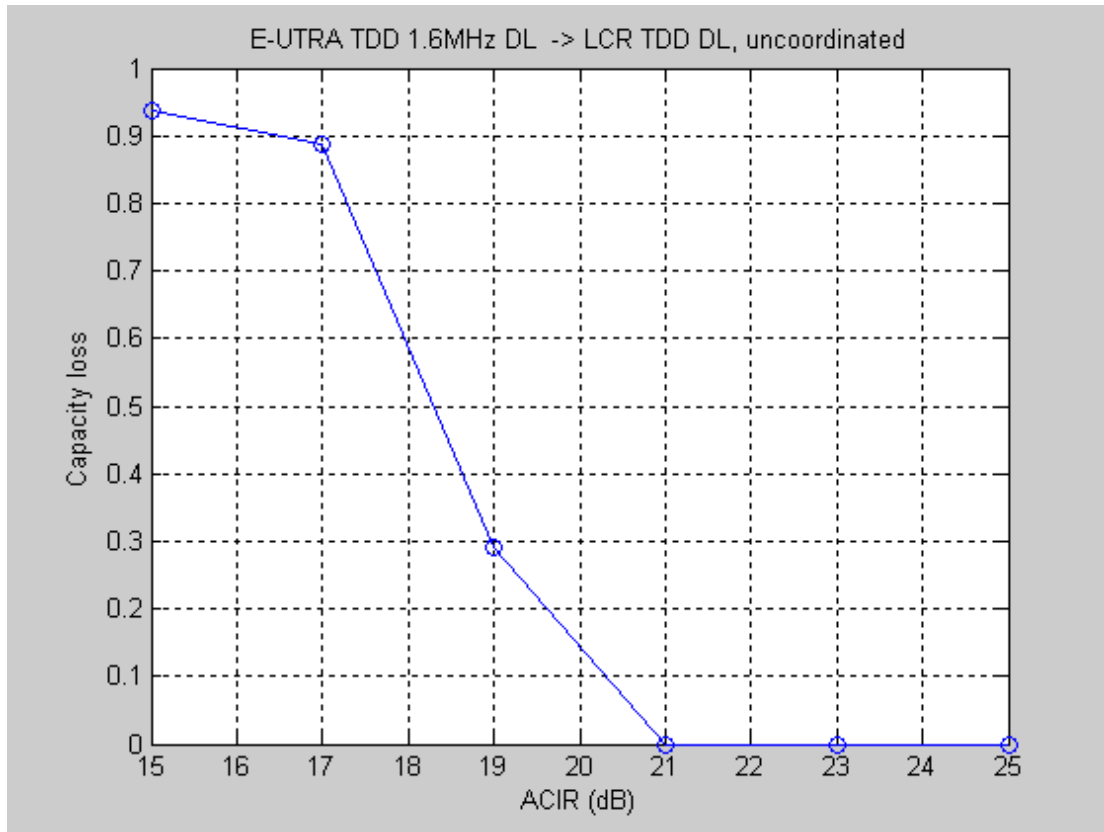

Figure 7.9: Capacity loss of UTRA 1.28 Mcps TDD DL with 1.6MHz E-UTRA DL aggressor, 35dBm BS output power, uncoordinated deployment

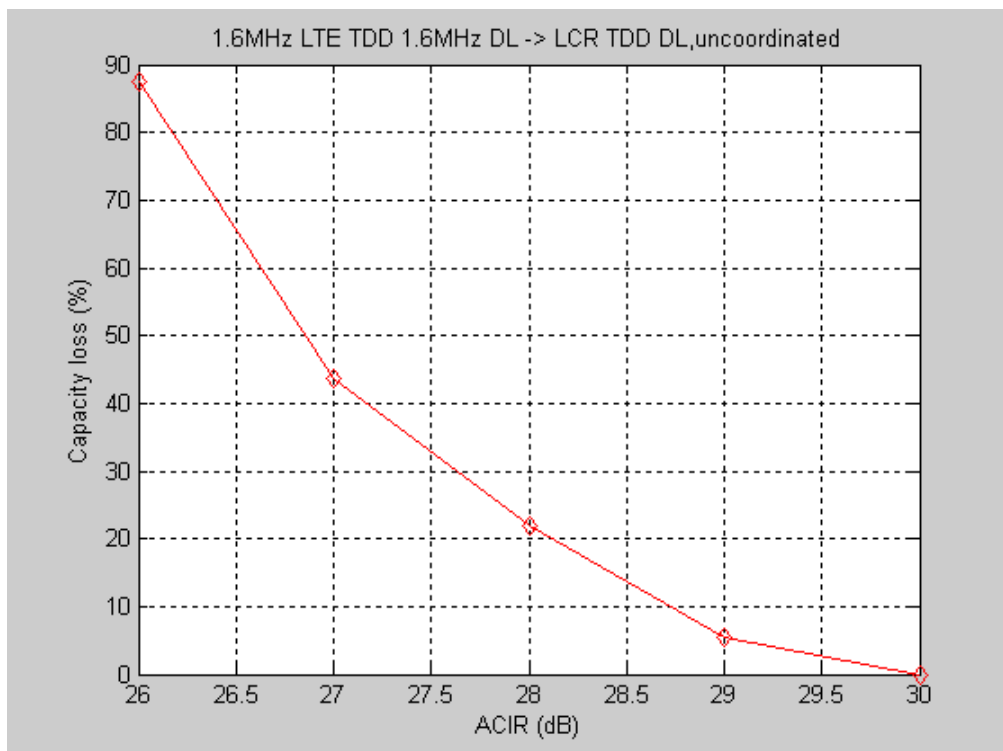

Figure 7.9a: Capacity loss of UTRA 1.28 Mcps TDD DL with 1.6MHz E-UTRA DL aggressor, 43dBm BS output power, uncoordinated deployment



### 7.1.2.4 ACIR uplink 5MHz E-UTRA interferer – UTRA 3.84 Mcps TDD victim

Simulations are based on the following assumptions:

Aggressor system:	5 MHz E-UTRA
Victim system:	UTRA 3,84 Mcps TDD using Enhanced Uplink
Simulation frequency:	2000 MHz
Environment:	Macro Cell, Urban Area, uncoordinated deployment
Cell Range	500 m

Simulation results for UTRA 3,84Mcps TDD uplink throughput loss are presented in table 7.8 (Power Control Parameter Set 1) and table 7.9 (Power Control Parameter Set 2). The results are also plotted in figure 7.10 (Average Throughput Loss) and figure 7.11 (5% CDF Throughput Loss).

Editors Note: Results were presented at RAN4#41 but need to be verified. Blank tables and figure titles are included here to keep consistent numbering.

**Table 7.8: UTRA 3,84 Mcps TDD uplink throughput loss (average & 5% CDF) for Parameter Set 1**

X (dB)	ACIR = 30 + X (dB)	Throughput Loss (%) – Parameter Set 1 (Gamma=1, CLx-ile=115)			
		IPWireless (R4-070037)		Ericsson (R4-061340)	
		Average	5% CDF	Average	5% CDF
-15	15	13.6	51.8	16.7	53.4
-10	20	7.3	20.8	8.6	21.4
-5	25	3.6	7.2	4.1	8.2
0	30	1.7	2.5	1.7	2.7
5	35	0.6	0.8	0.6	0.7
10	40	0.2	0	0.2	0
15	45	0	0	0	0
20	50	0	0	0	0

**Table 7.9: UTRA 3,84 Mcps TDD uplink throughput loss (average & 5% CDF) for Parameter Set 2**

X (dB)	ACIR = 30 + X (dB)	Throughput Loss (%) - Parameter Set 2 (Gamma=0.8, CLx-ile=133)			
		IPWireless (R4-070037)		Ericsson (R4-061340)	
		Average	5% CDF	Average	5% CDF
-15	15	12.2	33.4	13	35.1
-10	20	5.7	13.8	6.4	15.5
-5	25	2.5	4.4	2.8	5.6
0	30	1.1	1.0	1.1	1.9
5	35	0.3	0.2	0.4	0.5
10	40	0	0	0.1	0.2
15	45	0	0	0	0
20	50	0	0	0	0

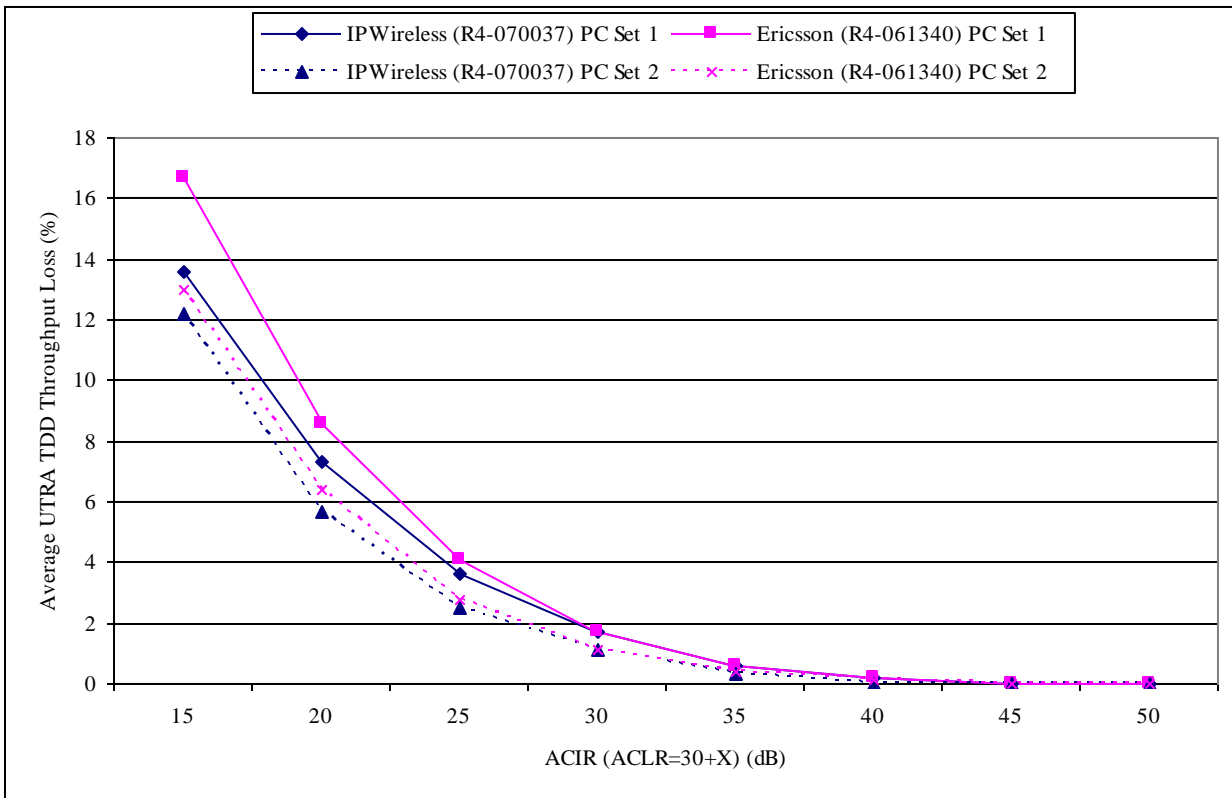

Figure 7.10: average UTRA 3,84 Mcps TDD uplink throughput loss

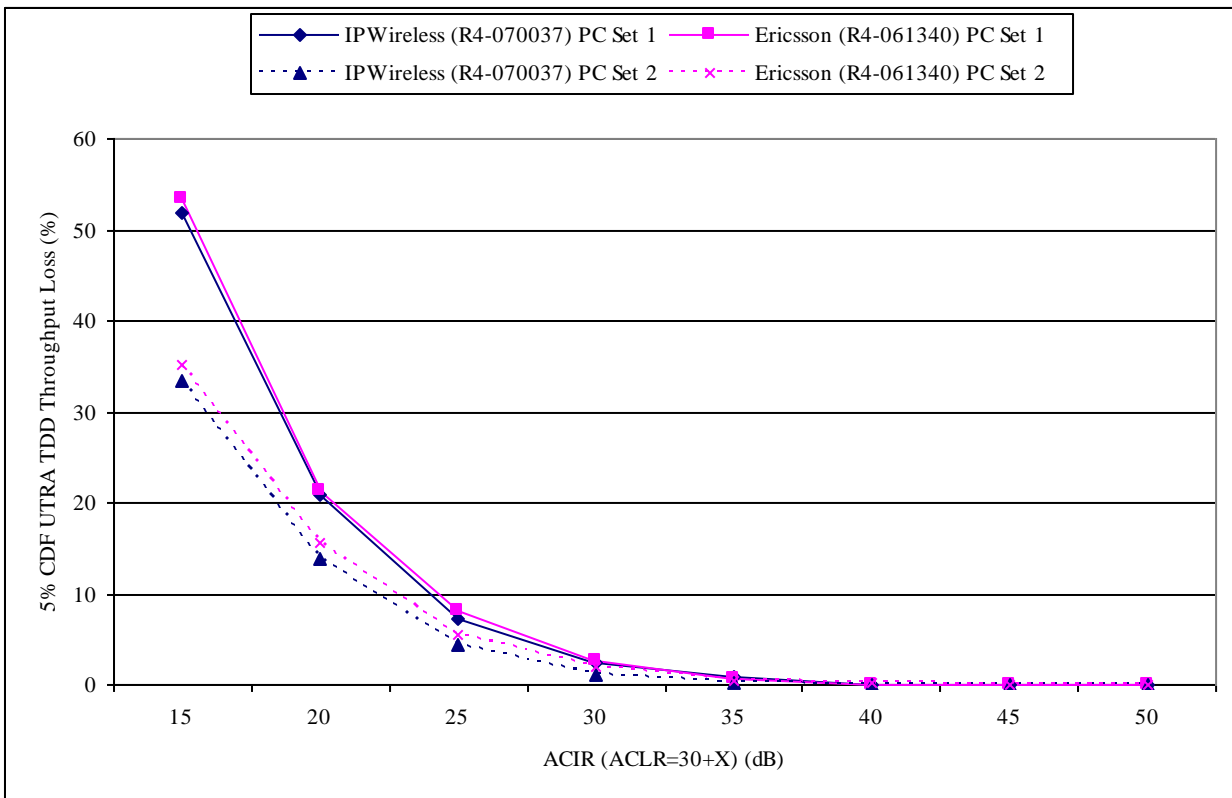

Figure 7.11: 5% CDF UTRA 3,84 Mcps TDD uplink throughput loss

### 7.1.2.5 ACIR uplink 10MHz E-UTRA interferer – 10MHz E-UTRA TDD victim

Simulations are based on the following assumptions:

Aggressor system:	10 MHz E-UTRA
Victim system:	10 MHz E-UTRA
Simulation frequency:	2000 MHz
Environment:	Macro Cell, Urban Area, uncoordinated deployment
Cell Range	500 m

Simulation results for average E-UTRA TDD uplink throughput loss are presented in table 7.10 (Power Control Parameter Set 1) and table 7.11 (Power Control Parameter Set 2). The results are also plotted in figure 7.12 (average throughput loss) and figure 7.13 (5% CDF throughput loss).

**Table 7.10: E-UTRA TDD uplink throughput loss (average & 5% CDF) – Parameter Set 1**

X (dB)	ACIR = 30 + X (dB)	Throughput Loss (%) - Parameter Set 1 (Gamma=1, CLx-ile=112)			
		IPWireless (R4-061312)		Ericsson (R4-061319)	
		Average	5% CDF	Average	5% CDF
-15	15			18.1	41.4
-10	20	12	20	9.6	17.9
-5	25	6.9	12	4.7	6.5
0	30	3.6	5.8	2.0	2.8
5	35	1.8	2.6	0.8	1.2
10	40	0.8	1.1	0.2	0.2
15	45	0.3	0.4	0.0	0.0
20	50	0.1	0.2	0.0	0.0

**Table 7.11: E-UTRA TDD uplink throughput loss (average & 5% CDF) – Parameter Set 2**

X (dB)	ACIR = 30 + X (dB)	Throughput Loss (%) - Parameter Set 2 (Gamma=0.8, CLx-ile=129)			
		IPWireless (R4-061312)		Ericsson (R4-061319)	
		Average	5% CDF	Average	5% CDF
-15	15			12.5	30.7
-10	20	10.2	14	6.1	13.1
-5	25	5.6	7.8	2.7	4.7
0	30	2.7	3.9	1.1	1.1
5	35	1.4	2.1	0.4	0.4
10	40	0.7	1.1	0.1	0.2
15	45	0.3	0.6	0.0	0.0
20	50	0.2	0.2	0.0	0.0

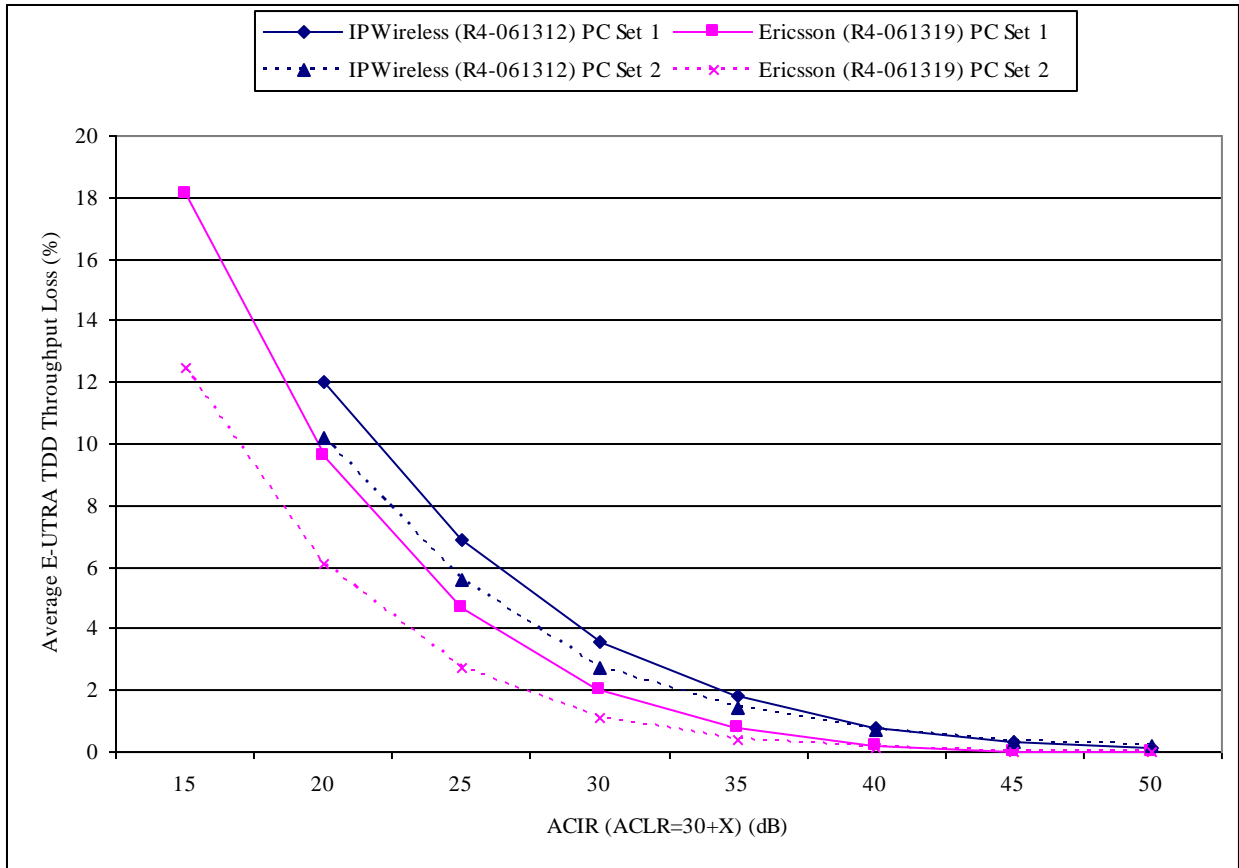

Figure 7.12: average E-UTRA TDD uplink throughput loss

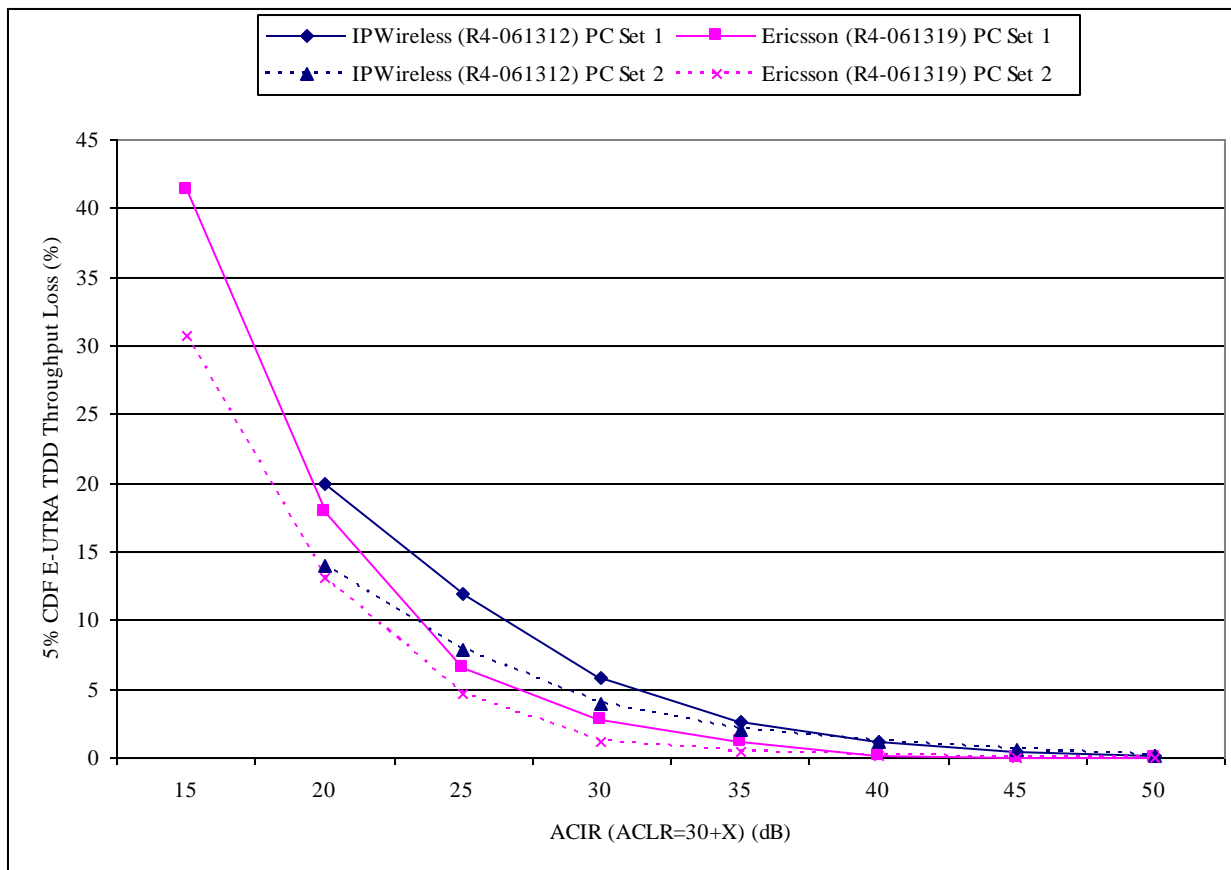

Figure 7.13: 5% CDF E-UTRA TDD uplink throughput loss

7.1.2.6 ACIR uplink 10MHz E-UTRA interferer – 10MHz E-UTRA TDD victim (LCR frame structure based)

Simulations are based on the following assumptions:

- Aggressor system: 10 MHz E-UTRA (LCR TDD frame structure based)
- Victim system: 10 MHz E-UTRA (LCR TDD frame structure based)
- Simulation frequency: 2000 MHz
- Environment: Macro Cell, Urban Area, uncoordinated deployment
- Cell Range 500 m

Link level performance is specified in Annex A.4. Simulation results for average E-UTRA uplink throughput loss are presented in figure 7.14. Simulation results for 5% CDF E-UTRA uplink throughput loss are presented in figure 7.15.

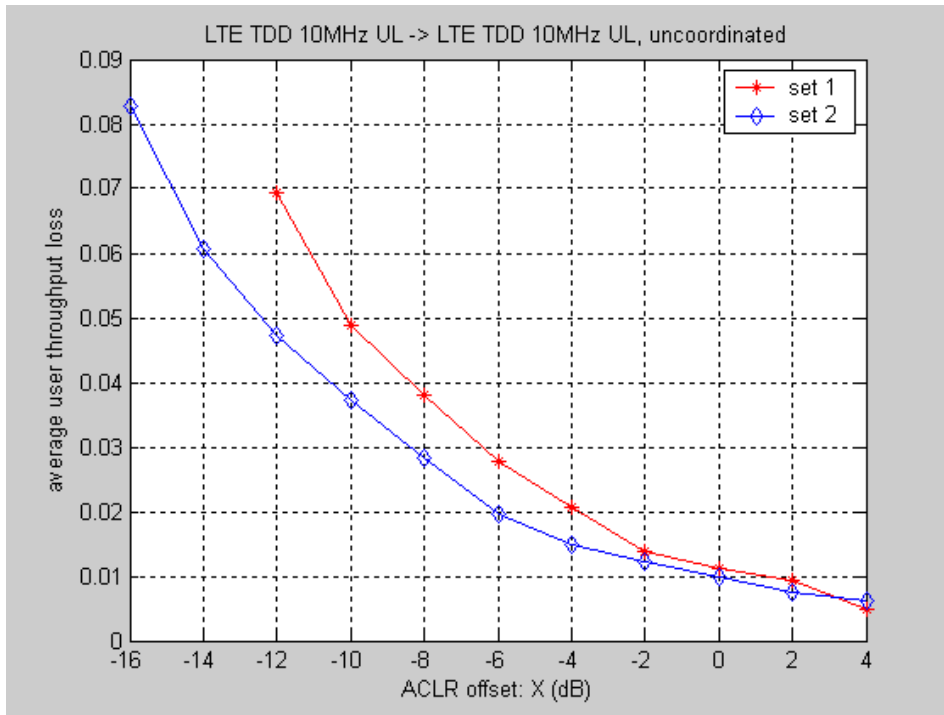

Figure 7.14: average E-UTRA TDD uplink throughput loss

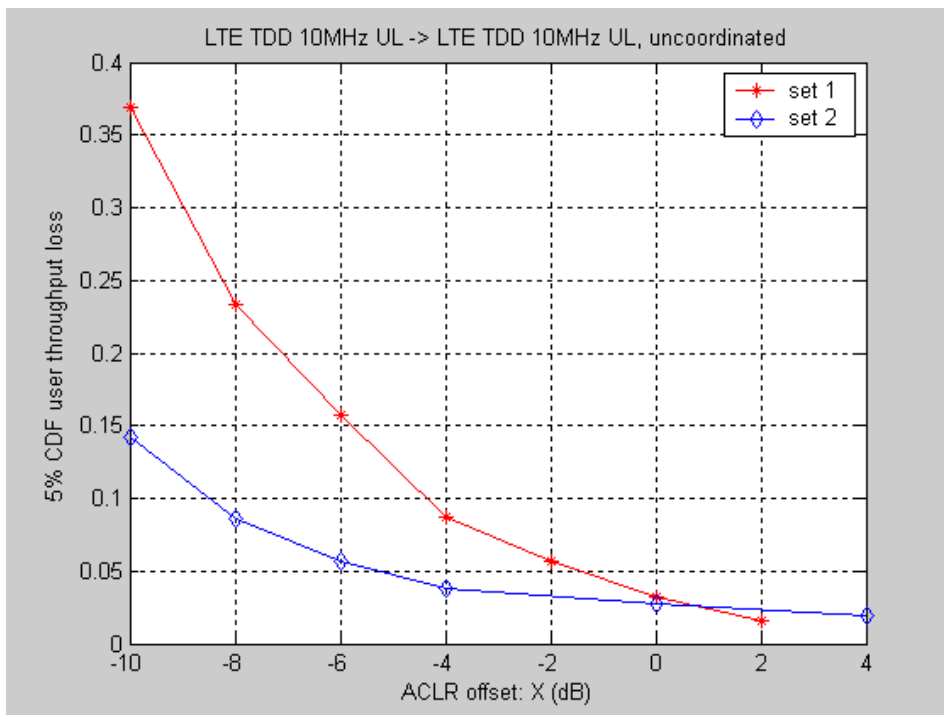

Figure 7.15: 5% CDF E-UTRA TDD uplink throughput loss

7.1.2.7 ACIR downlink 10MHz E-UTRA interferer – 10MHz E-UTRA TDD victim (LCR frame structure based)

Simulations are based on the following assumptions:

Aggressor system: 10 MHz E-UTRA (LCR TDD frame structure based)

Victim system: 10 MHz E-UTRA (LCR TDD frame structure based)

Simulation frequency: 2000 MHz  
Environment: Macro Cell, Urban Area  
Cell Range 500 m

Link level performance is specified in Annex A.4. Simulation results for average E-UTRA downlink throughput loss are presented in figure 7.16. Simulation results for 5% CDF E-UTRA downlink throughput loss are presented in figure 7.17.

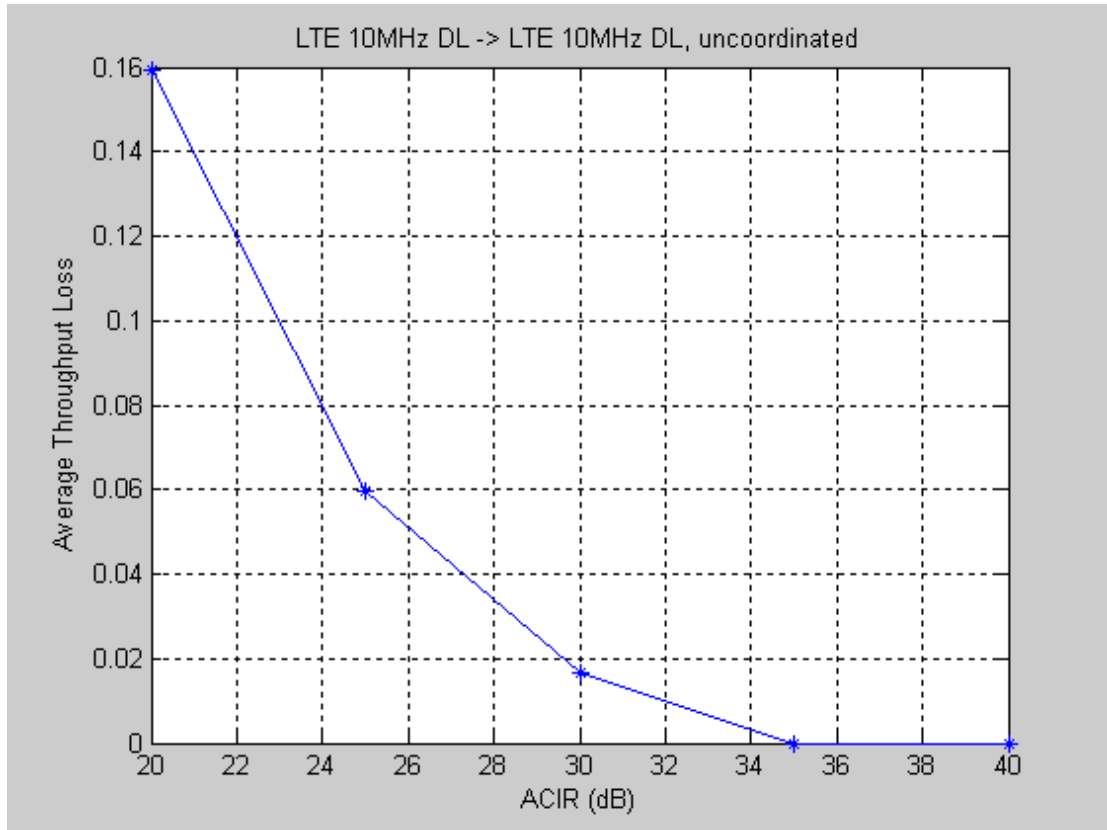

Figure 7.16: average E-UTRA TDD downlink throughput loss, uncoordinated deployment

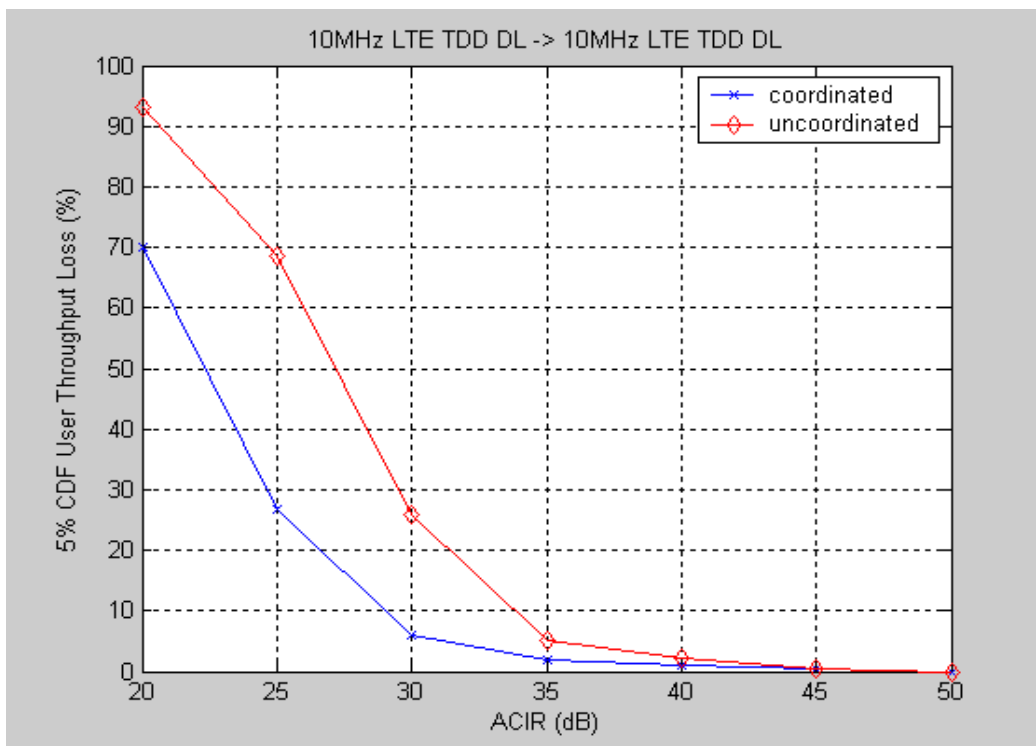

Figure 7.17: 5% CDF E-UTRA TDD downlink throughput loss, coordinated and uncoordinated deployment

### 7.1.3 Additional coexistence simulation results

In this section, additional co-existence simulation results are collected. Assumptions for these simulations may differ from those described in section 5 of the present document.

#### 7.1.3.1 ACIR downlink E-UTRA interferer – GSM victim

The key simulation parameters are summarized in table 7.12. The E-UTRA and system scenario parameters are as described in section 5 of the present document for rural macro cell environment with un-coordinated base-station deployment, and the GSM parameters are taken from [2] (Scenario\_2: UMTS (macro)-GSM (macro) in rural area). Different to the simulation assumptions in [2], no correction of LTE BS ACLR according to a spectrum mask was applied and the interference was assumed “flat” across all GSM carriers. The GSM ACS was set such that the resulting ACIR was dominated by the E-UTRA BS ACLR. For each ACIR value, E-UTRA base-stations transmit at maximum power (in order to produce maximum adjacent channel interference) and GSM UE are continuously added until the system is fully loaded. The success/failure status of a GSM UE is determined at a threshold of 0.5dB less than the required SINR target [2]. Simulation results [14] are presented in figure 7.18



**Table 7.12: Simulation parameters**

Parameters	E-UTRA	GSM	Notes
Uplink carrier frequency band	900 MHz		
Uplink System Bandwidth	1.25MHz	24 x 200kHz	
Number of carriers	1	4 cells/12 frequencies reuse, 2 carriers/sector	
Environment	Macro- Rural		
Cell radius	1km		cell range = 2 x radius = 2km
Base-stations	Un-coordinated distributed		Offset located at the edge of cell.
Transmission power	max. of 43dBm	Power controlled with UE and max. of 43dBm	
Network layout	36 cells (6x6), 108 sectors with wrap-around		

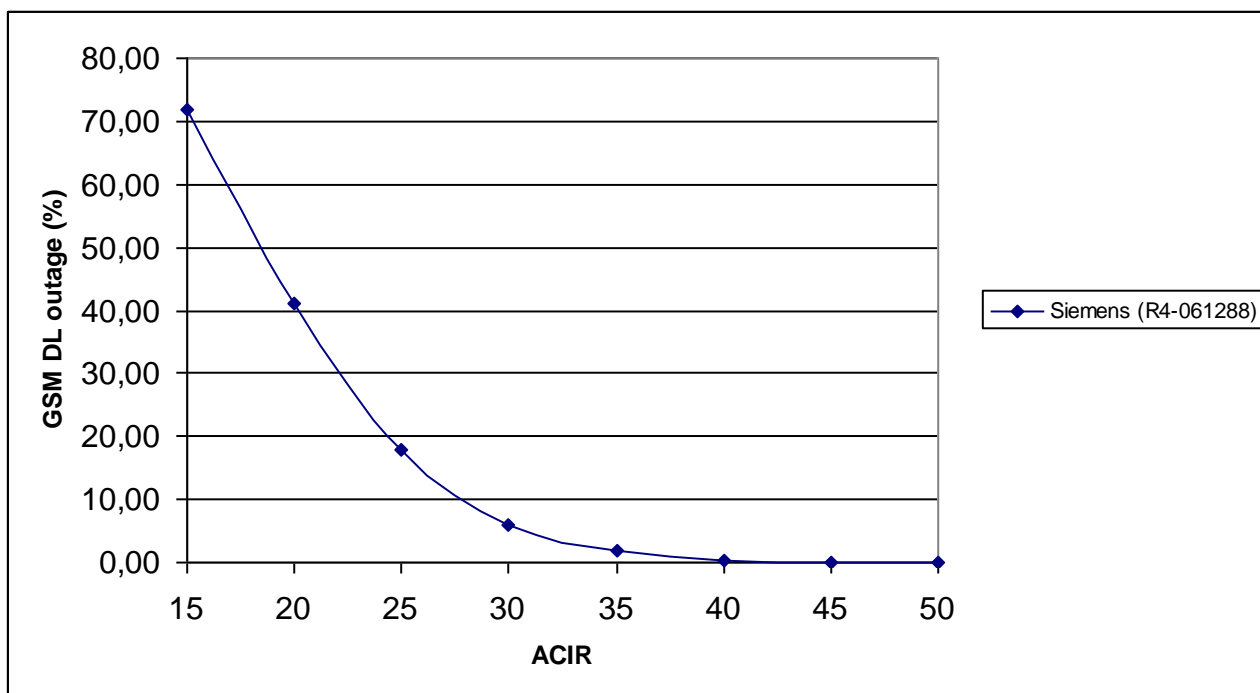

**Figure 7.19: GSM downlink outage**

An analytical investigation of E-UTRA-GSM downlink coexistence is provided in [15]. In the [2] the aggressing UTRA influence on GSM is modelled as constant ACIR over the whole GSM system bandwidth. The UTRA system load is according to [2], i.e. 5% outage.

For an E-UTRA system the interference generated to the GSM system can be modelled in the same way. Thus for a 5 MHz E-UTRA system the interference to the adjacent channel can be considered to be constant over the whole 5 MHz adjacent carrier. The other component of the ACIR in this case is the ACS of a GSM MS. In [2] this has been assumed to be significantly larger than the ACLR of the UTRA system and thus the main contribution to the ACIR is the ACLR. For coexistence with an E-UTRA aggressor and a UTRA victim the ACLR for EUTRA should be of the same order as for UTRA. In [2] the ACLR for UTRA is assumed to be 50 dB.

**Table 7.13: ACIR limit for 5% outage degradation in the GSM system for relevant system scenario s. Numbers from [2]**

Scenario 1 UMTS(macro)	GSM(macro) Urban 500m cell radius, Uncoordinated	27-31 dB
Scenario 2 UMTS(macro)	GSM(macro) Rural 5000m cell radius, Uncoordinated	26-29 dB
Scenario 5 UMTS(macro)	GSM(micro) Urban, Uncoordinated	26-40 dB

The ACIR values obtained in [2] for which 5% outage degradation occurs are listed in Table 7.13.

The difference between a UTRA and E-UTRA system is that for coexistence studies the E-UTRA system is assumed to use full power. However since the UTRA system has a reasonably high outage it will also use close to maximum power and the difference between E-UTRA and UTRA should only be a few dB.

In summary: For E-UTRA requirements on ACLR for the eNodeB similar to the requirements on UTRA, i.e. around 50 dB, the performance degradation on a GSM system is less than 5% outage degradation. This is also confirmed by the simulation results in figure 7.19. Thus the present coexistence scenario is not more constraining than the E-UTRA to E-UTRA and E-UTRA to UTRA scenarios considered so far and need not be considered when setting E-UTRA requirements.

In addition there are a number of factors that make the assumptions above slightly pessimistic:

- The interference in the neighboring channel has been assumed to be flat. In practical systems however it falls off, which makes the GSM carriers distant from the E-UTRA carrier less interfered. This will reduce the outage degradation.
- The E-UTRA system has been assumed to transmit at full power at all times. However this is rarely the case in practical systems. Thus the interference is lower and the outage degradation less.

For E-UTRA systems with narrower bandwidth than 5 MHz, e.g. 1.6 MHz the power spectral density in the interfering region is higher if we assume that the output power of an E-UTRA eNodeB is the same as for the 5 MHz system. The increase is 5 dB which would increase the requirements in table 7.13 with 5 dB. The interference will affect fewer GSM channels though since the fall off previously mentioned is steeper for a 1.6 MHz system.

### 7.1.3.2 ACIR uplink E-UTRA interferer – GSM victim

The key simulation parameters are summarized in table 7.14. The E-UTRA and system scenario parameters are as described in section 5 of the present document for rural macro cell environment with un-coordinated base-station deployment, and the GSM parameters are taken from [2] (Scenario\_2: UMTS (macro)-GSM (macro) in rural area). Simulations for two scenarios have been presented, (a) in [16] and (b) in [17]. Different to the simulation assumptions in [2], no correction of LTE UE ACLR according to a spectrum mask was applied and the interference was assumed “flat” across all GSM carriers. Consequently, the ACIR has been modelled as flat as well. The ACIR is here expressed in dBc/1x375kHz (a) and dBc/4x375kHz (b) For each ACIR value, E-UTRA UEs are firstly added to the system until it is fully loaded with 3 UEs/sector. Subsequently, GSM UEs are continuously added until the system is fully loaded. The success/failure status of a GSM UE is determined at the threshold of 0.5dB less than the required SINR target [2]. Simulation results [16, 17] are presented in figure 7.19

**Table 7.14: Simulation parameters**

Parameters	E-UTRA	GSM	Notes
Uplink carrier frequency band	900 MHz		
Uplink System Bandwidth	(a) 1.25MHz (3 frequency RBs with 1RB/UE = 3 UE/sector) (b) 5MHz (12 frequency RBs with 4RB/UE = 3 UE/sector)	(a) 24 x 200kHz (b) 12 x 200kHz	
Number of carriers	1	(a) 4 cells/12 frequencies reuse, 2 carriers/sector  (b) 4 cells/12 frequencies reuse, 1 carrier/sector	
Environment	Macro- Rural		
Cell radius	1km		cell range = 2 x radius = 2km
Base-stations	Un-coordinated distributed		Offset located at the edge of cell.
Transmission power	max. of 24dBm, min. of -30dBm	max. of 33dBm, min. of 5dBm	
Network layout	36 cells (6x6), 108 sectors with wrap-around		
Power control	PC set 1 as in section 5.1.1.6 $PL_{x-ile} = 121\text{dB}$ $\gamma = 1$	as in [2]	

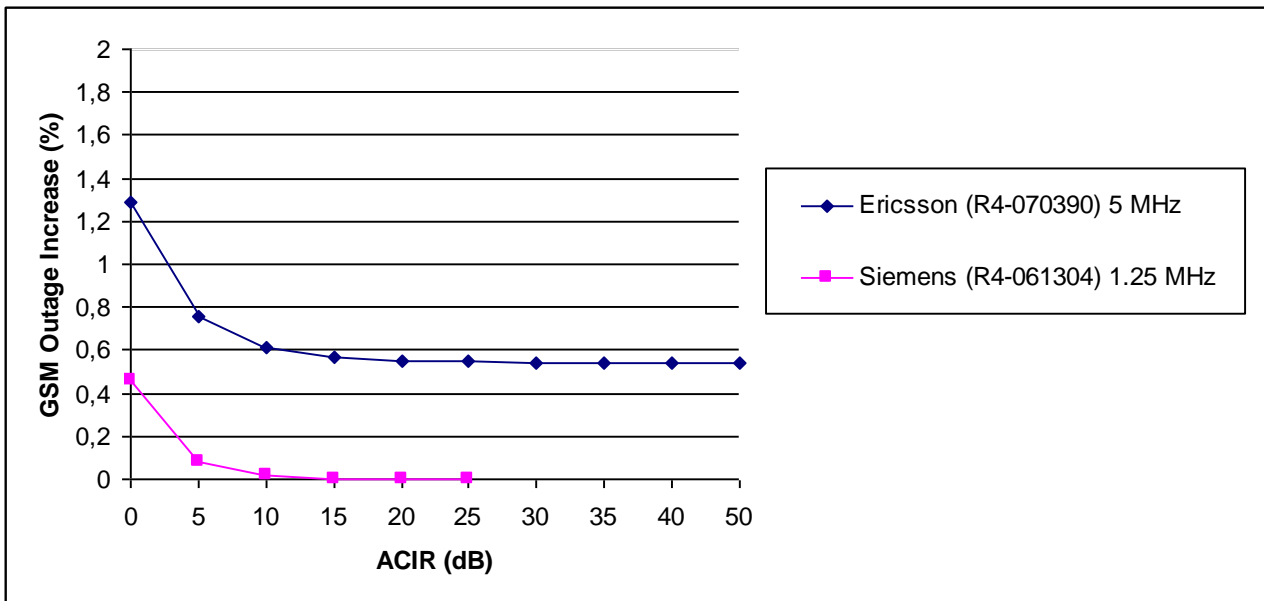

**Figure 7.19: GSM uplink outage**

The results show that the outage increase in both cases (a) and (b) is negligible even for flat ACLR/ACS and very low levels of ACIR.

### 7.1.3.3 Asymmetric coexistence 20 MHz and 5 MHz E-UTRA

Simulations are based on the following assumptions:

- Aggressor system: 20 MHz E-UTRA
- Victim system: 5 MHz E-UTRA

Simulation frequency: 2000 MHz

Environment: Macro Cell, Urban Area, uncoordinated deployment

Cell Range 500 m

Generalising from 5 MHz and 10MHz to the 20MHz bandwidth we make the following assumptions:

- 3 UEs per carrier for aggressor and victim
- The ACLR is expressed in dBc per bandwidth B occupied by the aggressing UE
- A 13dB ACLR improvement is assumed for frequency separations larger than B from the edge of the UE occupied bandwidth.

The simulation results are given in Figure 7.20 and the numerical data are presented in Table 7.15.

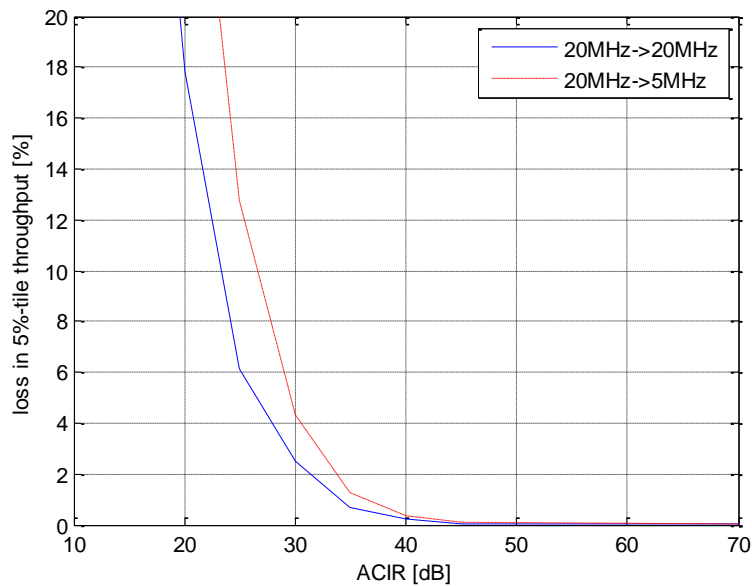

Figure 7.20: Loss in 5%-ile throughput versus ACIR [18]

Table 7.15: Numerical values [18]

ACIR (dB)	loss in 5%-ile throughput (%)	
	20MHz -> 5MHz	20MHz -> 20MHz
15	67.1%	42.3%
20	33.1%	17.8%
25	12.8%	6.2%
30	4.4%	2.5%
35	1.3%	0.7%
40	0.3%	0.2%
45	0.1%	0.1%

We also note some effects when a 5 MHz E-UTRA system aggresses a 20 MHz E-UTRA system. Considering the case where the victim network bandwidth is larger than the aggressing network bandwidth, the impact of the aggressing UEs to the victim BS is lower than for the case of symmetric bandwidth, because the "shoulder" of the ACLR of the immediately adjacent aggressing UE will cover a smaller bandwidth of the victim network. This case is therefore uncritical.

### 7.1.3.4 Impact of cell range and simulation frequency on ACIR

The impact of cell range and simulation frequency is analysed by comparing downlink scenarios with simulation frequency of 900MHz (1.25MHz system bandwidth) and 2GHz (10MHz system bandwidth) and cell ranges of 500m, 2000m and 5000m in urban and rural area environment.

For the 2GHz rural environment case 18dBi antenna gain and 45m antenna height were assumed. Propagation model for the 2GHz rural environment case is according to section 4.5.3 modified for 2GHz and 45m antenna height with the following formula:

$$L = 100,5 + 34,1\log_{10}(R)$$

Where:

R is the base station-UE separation in kilometres

Figure 7.21 presents average system throughput loss in percent relative to the reference throughput without external system interference. Figure 7.22 presents 5% CDF user throughput loss in percent relative to the reference throughput without external system interference.

**E-UTRA DL average system throughput loss vs ACIR**

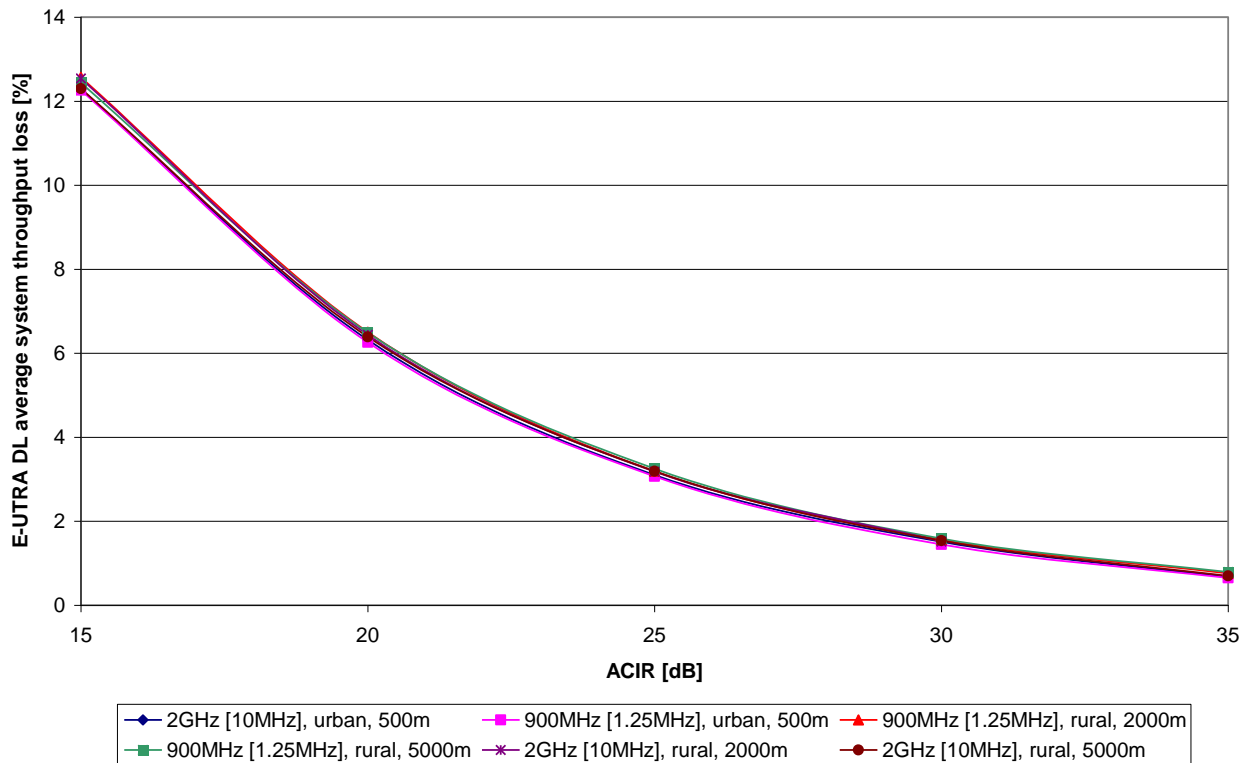

**Figure 7.21: Average system throughput loss in downlink**

5% CDF E-UTRA DL user throughput loss vs ACIR

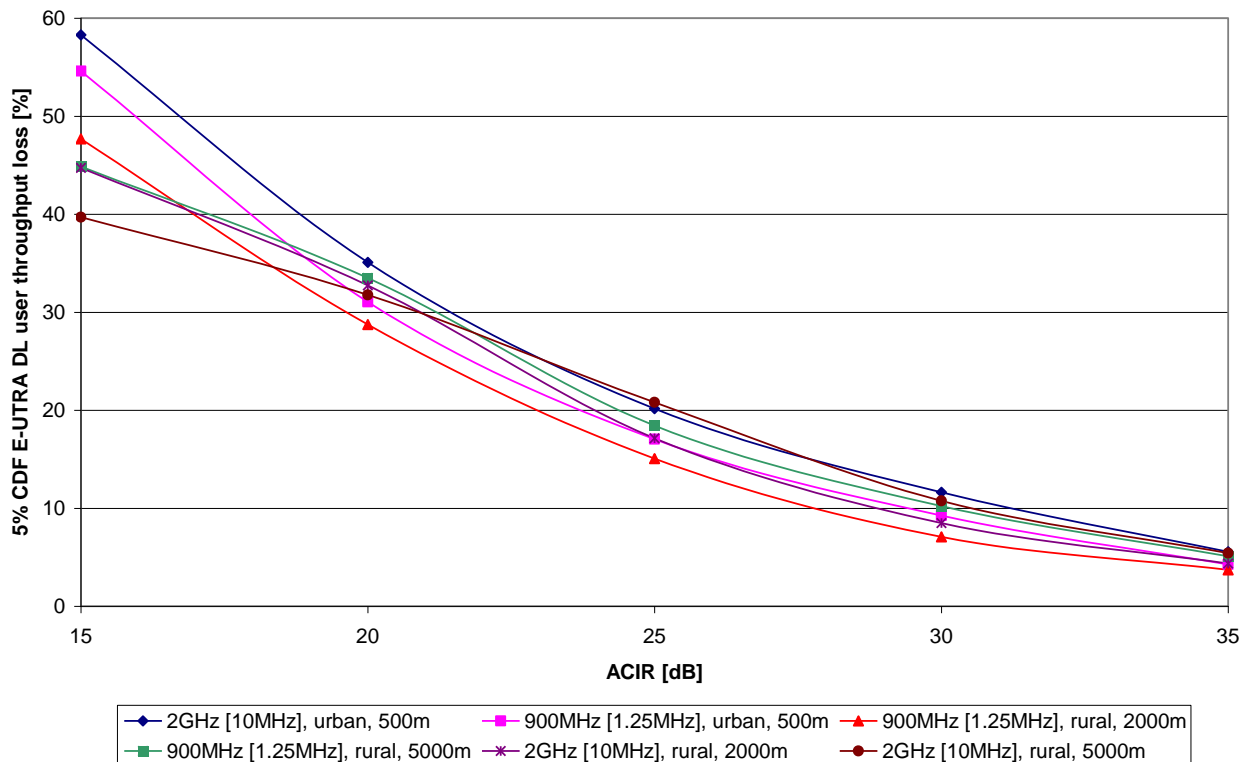

Figure 7.22: 5% CDF user throughput loss in downlink

On the basis of the simulation results it can be assumed that the worst case scenario is 2GHz, urban environment, 500m cell range.

7.1.3.5 Uplink Asymmetric coexistence TDD E-UTRA to TDD E-UTRA

Simulations are based on the base scenarios in Table 5.2B with following assumptions in Table 7.16:

Table 7.16: Simulation assumptions based on 3 base scenarios

Parameter	Scenario 1	Scenario 2	Scenario 3
Aggressor's Bandwidth	15 MHz	20 MHz	20 MHz
Victim's Bandwidth	10 MHz	10 MHz	5 MHz
Frequency	2000 MHz		
Environment	Macro Cell, Urban Area, uncoordinated deployment		
Cell range	500 m		
FACLR	0 dB		

Simulation results are presented in Table 7.17 and plotted in Figure 7.23 and 7.24 for the average throughput loss and 5% CDF throughput loss for Power Control Parameter Set 1. The symmetrical results of 10 MHz TDD E-UTRA to 10 MHz TDD E-UTRA are also plotted for reference.

Table 7.17: Simulation results for Power Control Set 1 ( $F_{ACLR} = 0, P_{ACLR} = 0$ )

ACIR (dB)		Average Throughput Loss (%)			5% CDF Throughput Loss (%)		
X	30 + X	Scenario 1	Scenario 2	Scenario 3	Scenario 1	Scenario 2	Scenario 3
-15	15	26.0	31.5	47.9	64.3	73.5	89.1
-10	20	15.0	18.0	30.8	30.4	40.9	72.3
-5	25	6.9	10.1	18.2	11.0	16.0	38.5
0	30	3.3	4.9	9.1	4.1	5.8	13.3
5	35	1.4	2.3	4.6	1.0	1.7	5.5
10	40	0.2	1.2	2.4	0.7	0.5	1.7
15	45	0.0	0.5	0.6	0.4	0.2	0.3
20	50	0.0	0.0	0.0	0.0	0.0	0.0

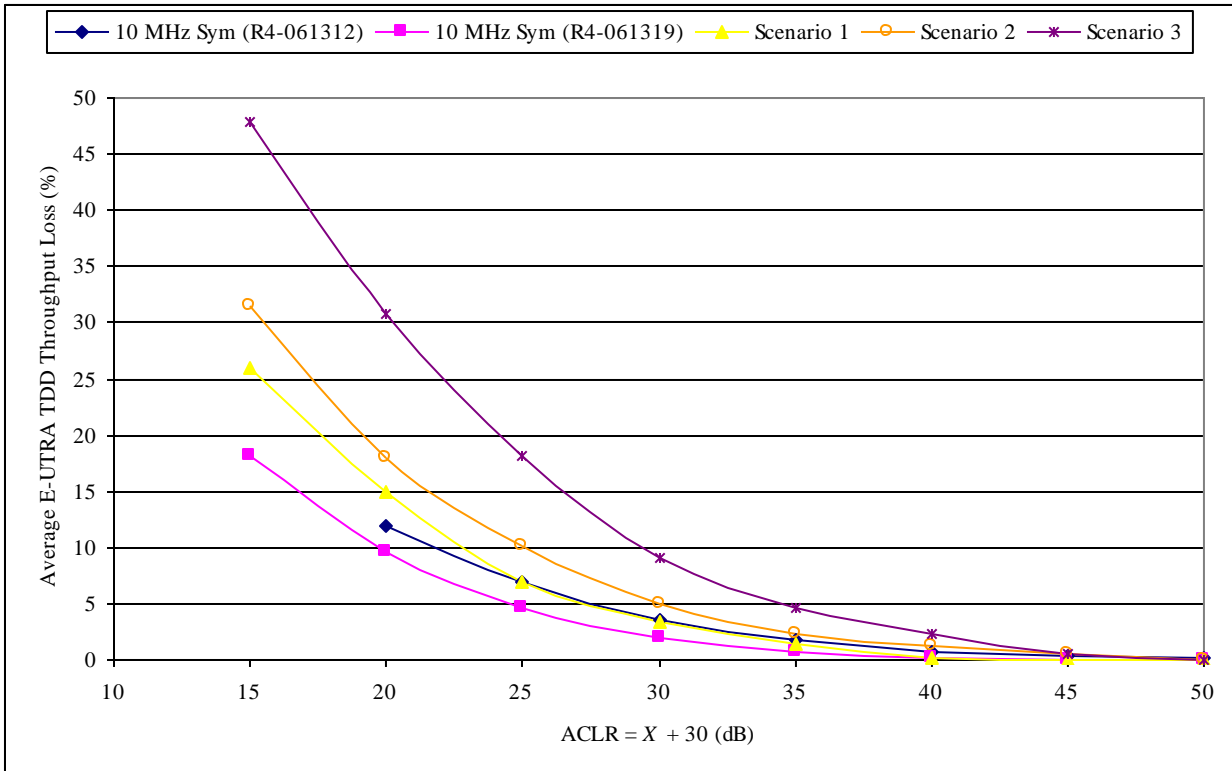

Figure 7.23: Average throughput loss (PC Set 1)

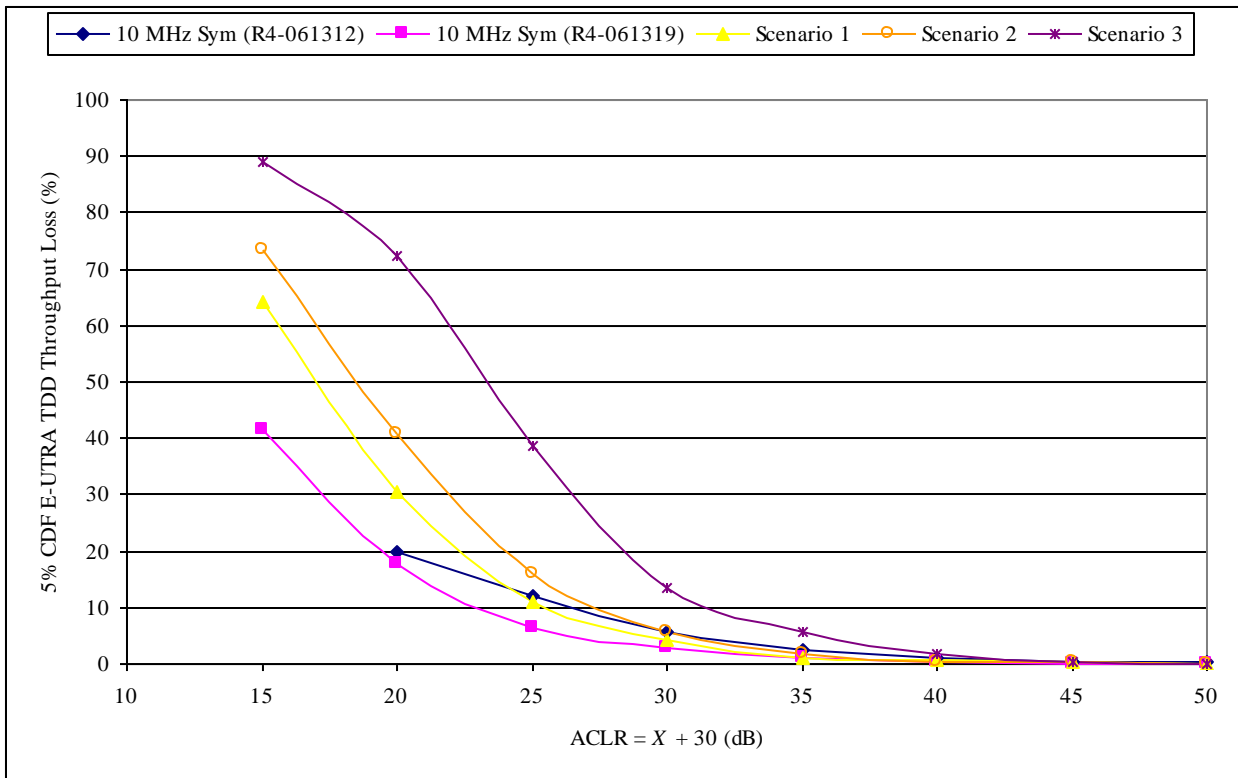

Figure 7.24: 5% CDF throughput loss (PC Set 1)

### 7.1.4 Base station blocking simulation results

Figure 7.25 and Figure 7.26 show the CDF curves of the total received power level in 10MHz bandwidth at the own system base stations in other system operating frequency (blocking scenario) from all other system terminals, using power control parameter set 1 and set 2, respectively. The signal from all own system terminals was decreased by 49dB (assuming terminal noise floor of -30dBm/1MHz it is 49dBc/3MHz for a 24dBm terminal). The same simulator and simulation assumptions were used as for coexistence studies in uplink for the E-UTRA system in 10MHz system bandwidth.



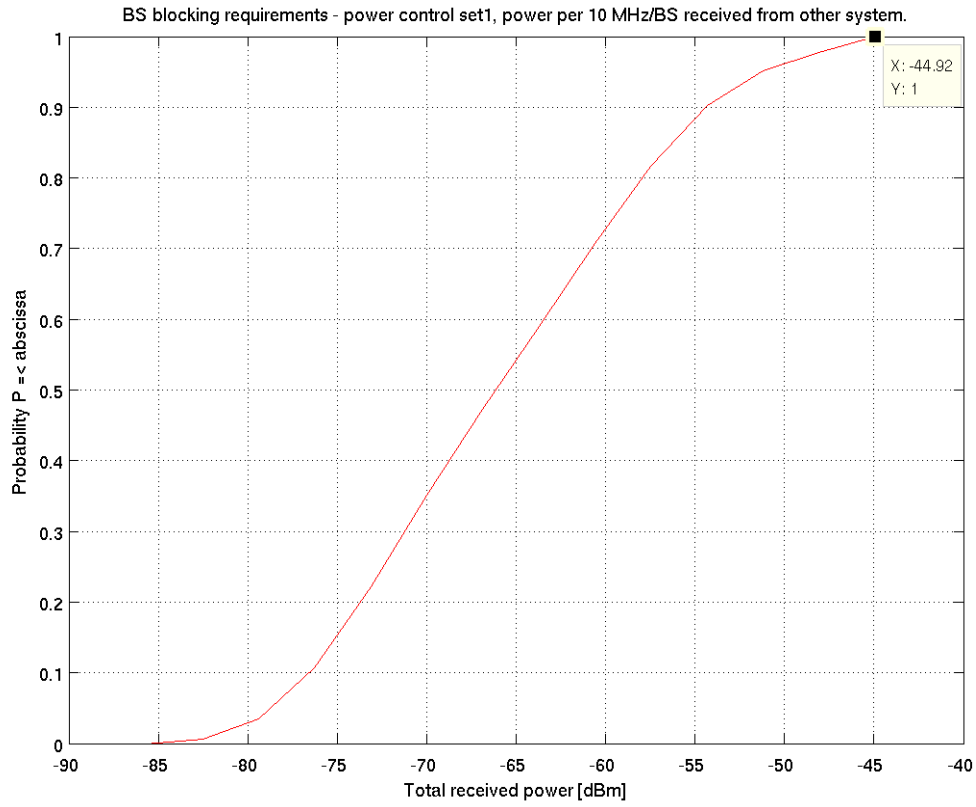
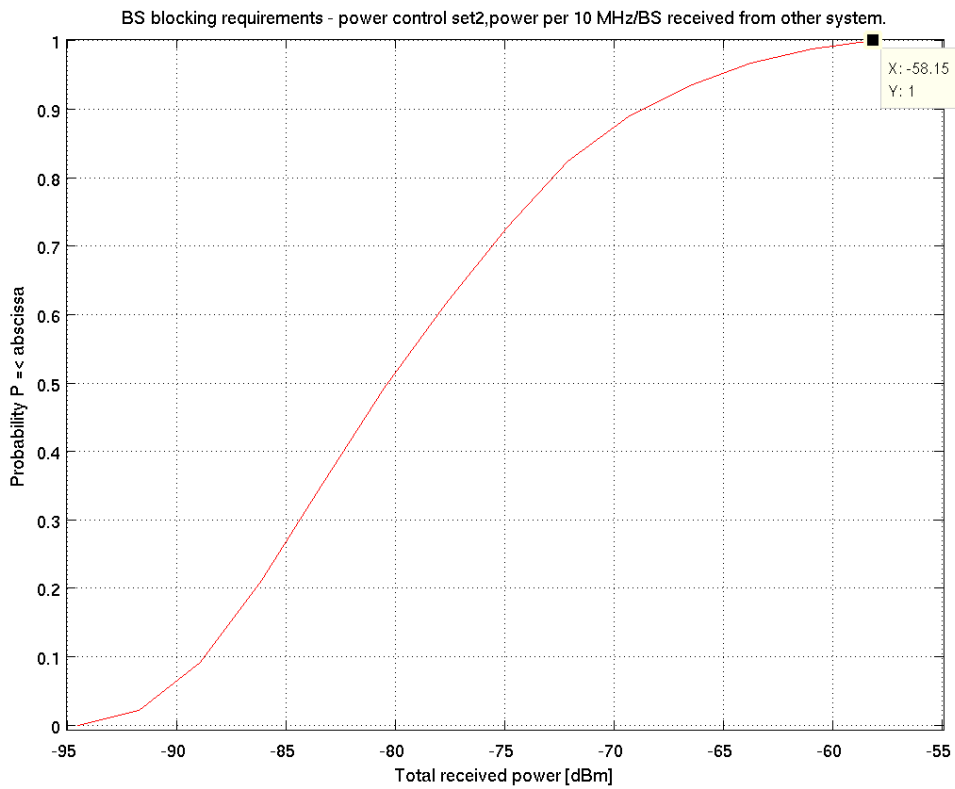

Figure 7.25: CDF of the total received power level at the own system base stations (10MHz) from all other system terminals, PC set 1



**Figure 7.26: CDF of the total received power level at the own system base stations (10MHz) from all other system terminals, PC set 2**

Total received power level was assumed here for simplicity, however it should be noted that this may be pessimistic as the most relevant RX impairments are a nonlinear function of the blocker received power levels present at the receiver input.

It is proposed the mean power of the interfering signal is equal to -43dBm which is a compromise between the 30dBm Maximum Output Power terminals defined in TR 36.803 and the 24dBm assumption in TR 36.942 under worst case MCL conditions.

## 7.2 RRM

---

# 8 Rationales for co-existence requirements

## 8.1 BS and UE ACLR

The metric for the degradation of a victim system by the presence of an interfering system on adjacent channel in the present document is the capacity loss (for UTRA as victim) or throughput loss (for E-UTRA as victim) in dependence of Adjacent Channel Interference Ratio (ACIR). ACIR is defined as

$$ACIR = \frac{1}{\frac{1}{ACLR} + \frac{1}{ACS}}$$

ACLR is the Adjacent Channel Leakage power Ratio of the interfering systems transmitter (specified as the ratio of the mean power centred on the assigned channel frequency to the mean power centred on an adjacent channel frequency) and ACS is the corresponding receiver requirement on Adjacent Channel Selectivity of the victim system receiver.

It is assumed that the capacity or throughput loss of the victim system shall not exceed 5%. It is also assumed that ACIR is dominated by the UE ACLR.

### 8.1.1 Requirements for E-UTRA – UTRA co-existence

In this case UTRA sets some constraints as ACLR and ACS as E-UTRA would need to be deployed adjacent to both UTRA and E-UTRA. The two scenarios are shown in figure 8.1

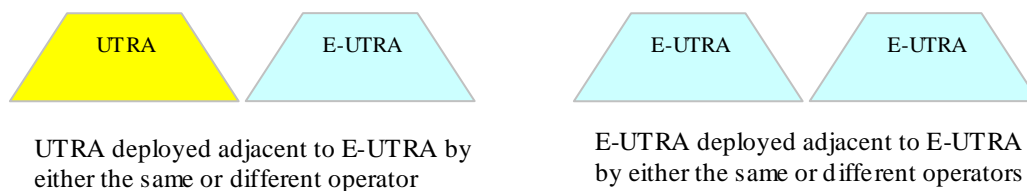

**Figure 8.1: E-UTRA deployment scenarios**

BS ACLR can be obtained from downlink simulation results presented in section 7.1.1.1. For 5% UTRA capacity loss an E-UTRA BS ACLR of at least 33dB is required. Assuming the legacy UTRA ACLR of 45dB for E-UTRA BS will result in less than 3% UTRA capacity loss.

UE ACLR can be obtained from uplink simulation results presented in section 7.1.1.3. It must be noted that the simulation assumptions represent a multiple worst case scenario which is unlikely to for real network deployments. The simulation results for power control set 1 and set 2 represent therefore the upper and lower boundary for the required

ACIR. It was demonstrated in [9] that the more aggressive power control set 1 does not improve the throughput in some scenarios. Moreover, additional improvements by more advanced schedulers demonstrated in [10], [11], [12], have not been taken into account for the simulations. Considering in addition UE implementation constraints, a UE ACLR of 33dB represents a balanced approach of system performance and UE complexity which is discussed in [13].

## 8.1.2 Requirements for E-UTRA – E-UTRA co-existence

UE ACLR can be obtained from downlink simulation results presented in section 7.1.1.4. With an E-UTRA UE ACLR of 30dB the mean and cell edge user throughput degradation is less than 3% for both power control set 1 and power control set 2 and not taking into account the additional improvements by more advanced scheduler mentioned previously.

# 9 Deployment aspects

E-UTRA provides a significant number of features which can be exploited to support operation in diverse frequency bands. The purpose of this section is to provide informative description how these features can be augmented in a practical deployment

## 9.1 UE power distribution

Three scenarios have been considered, with the simulation assumptions listed in Table 9.1. Note for scenario 3, the propagation model is adopted from TR25.814 [4], where the penetration loss is included in the propagation model.

**Table 9.1: simulation assumptions**

Simulation	CF	ISD	MCL	Propagation model	BS antenna pattern and gain
Cases	(GHz)	(meters)	(dB)	(dB)	
1	2.0	750 urban macro-cell size in 36.942	70	$128.1 + 37.6 \log(R)$ , R in kilometers	15dBi $A(\theta) = -\min \left[ 12 \left( \frac{\theta}{\theta_{3dB}} \right)^2, A_m \right]$ $\theta_{3dB} = 65$ degrees, $A_m = 20$ dB
2	2.0	1732 macro-cell size in 25.814	70	$128.1 + 37.6 \log(R)$ , R in kilometers	15dBi $A(\theta) = -\min \left[ 12 \left( \frac{\theta}{\theta_{3dB}} \right)^2, A_m \right]$ $\theta_{3dB} = 65$ degrees, $A_m = 20$ dB
3	2.0	130 micro-cell size in 25.814	53	$L[dB] = 7 + 56 \log_{10}(d[m])$ (Outdoor to indoor, penetration included)	<u>6 dBi for micro cell case with omni-antennas</u> $A(\theta) = 1$

As for LTE UL power control, each LTE UE's power is adjusted according to the following power control scheme:

$$P_t = P_{\max} \times \min \left\{ 1, \max \left[ R_{\min}, \left( \frac{CL}{CL_{x-ile}} \right)^\gamma \right] \right\}$$

where  $P_{\max} = 24\text{dBm}$ ,  $R_{\min} = -54\text{dB}$  if UE minimum power is  $-30\text{dBm}$  (or  $R_{\min} = -64\text{dB}$  if UE minimum power is  $-40\text{dBm}$ ),  $CL_{x-ile}$  and  $\gamma$  are set according to Table 9.2:

**Table 9.2: Power control algorithm parameter**

Parameter set	Gamma	CLx-ile	
		10MHz bandwidth	5 MHz bandwidth
Set 1	1	112	115
Set 2	0.8	129	133

### 9.1.1 Simulation results

Fig. 9.1 shows the UE transmit power distribution for different scenarios when different PC parameters are used. Several observations are made for the as follows:

- For each scenario, the CDF curves for  $P_{\min} = -30\text{dBm}$  and  $P_{\min} = -40\text{dBm}$  almost overlap with each other except for the power region where UEs transmit around minimum power.
- Generally speaking, UE transmit power for case 2 is greater than that for case 1 for the power region where UEs transmit at high power. This is because case 2 has larger cell size and results in higher UE power for UEs located close to cell border. This is also confirmed in Table 9.3 that presents UE mean and 95% CDF power for different scenarios.
- For case 3 where a micro cell size is simulated, UE transmit power is not always lower than that for case 1 or 2. The reason is that the pathloss model as shown in Table 9.1 includes penetration loss. As a result, the pathloss is not necessarily smaller than that in case 1 or 2, where no penetration loss is considered. Since the PC scheme is based on UE pathloss, the resulting UE power is not necessarily lower either. However, as shown in Table 9.3, the UE mean and 95% CDF power is significantly lower than their counterparts in case 1 or 2.

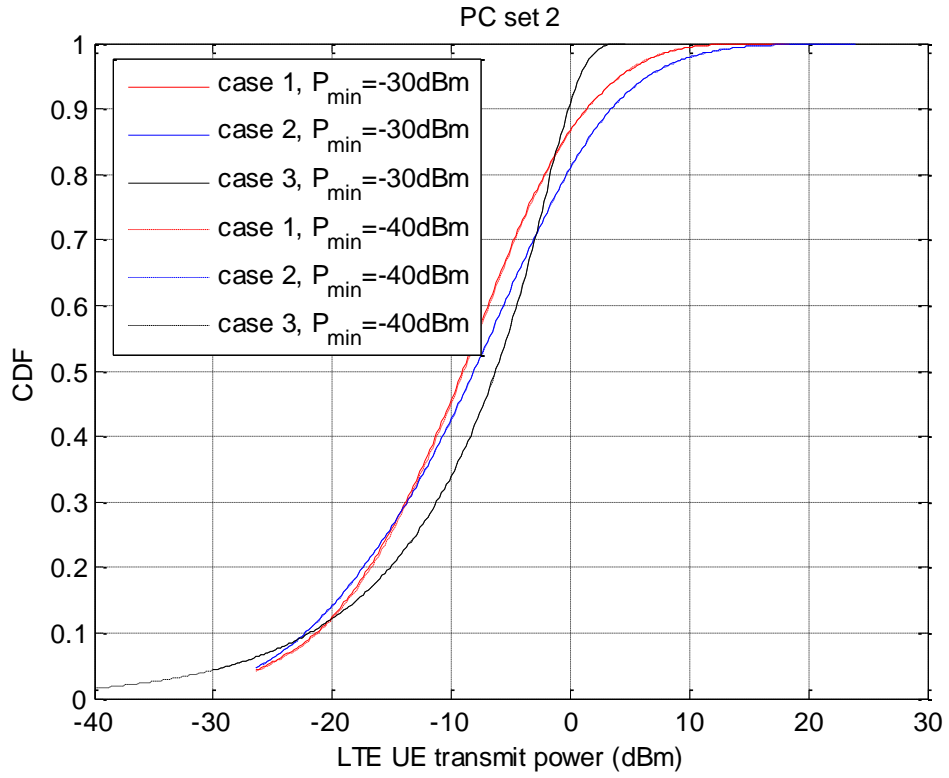

Figure 9.1: LTE UE transmit power CDF (PC set 2)

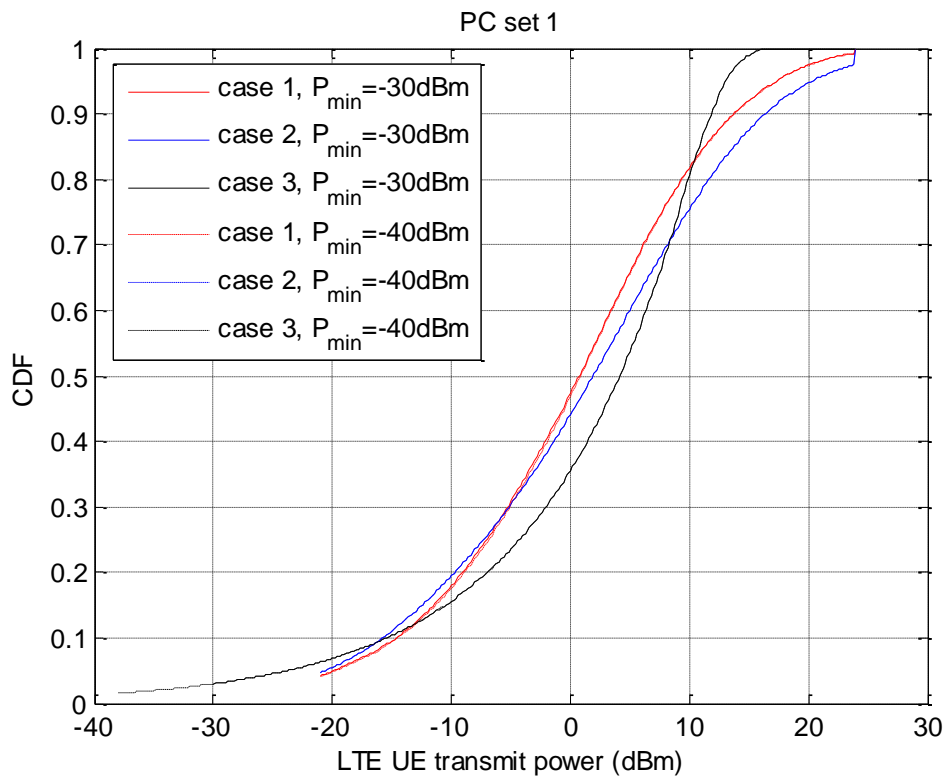

Figure 9.2: LTE UE transmit power CDF (PC set 1)

Fig. 9.2 shows the UE transmit power distribution for different scenarios when different PC parameters are used. Similar observations as mentioned for Fig. 9.1 can be made except for the fact that UEs transmit at a lower power than when PC set 1 is used, which is expected.

**Table 9.3: UE mean and 95% CDF power for PC set 1 and set 2**

Simulation Cases	Power control parameters	UE minimum power = -30dBm		UE minimum power = -40dBm	
		UE mean power (dBm)	UE 95% CDF power (dBm)	UE mean power (dBm)	UE 95% CDF power (dBm)
1	PC set 1	10.4	17.3	10.4	17.3
	PC set 2	-2.1	4.2	-2.1	4.2
2	PC set 1	12.6	20.3	12.6	20.3
	PC set 2	0.9	6.5	1	6.6
3	PC set 1	7.5	13	7.5	13
	PC set 2	-4.1	0.8	-4.1	0.8

## 10 Multi-carrier BS requirements

The purpose of this section is to provide guidance how to interpret transmitter and receiver requirements for multi-carrier BS.

### 10.1 Unwanted emission requirements for multi-carrier BS

#### 10.1.1 General

In section 6.6 of TS 36.104 [19], unwanted emission requirements for single carrier or multi-carrier BS are specified. This multi-carrier BS corresponds to the multi-carrier BS of the same channel bandwidth for E-UTRA. The following two pragmatic scenarios can be considered.

- multi-carrier BS of different E-UTRA channel bandwidths
- multi-carrier BS of E-UTRA and UTRA

Different LTE channel bandwidths have different operating band unwanted emissions requirement. Only 5 MHz and higher channel bandwidths have the same requirement. E-UTRA and UTRA have different mask requirements. In section 10.1.2 and 10.1.3, unwanted emission requirements for BS with different channel bandwidths and in case of E-UTRA and UTRA with following limited scenarios are introduced as a guideline.

- multi-carrier BS of different E-UTRA channel bandwidths covering only 5 MHz and higher channel bandwidths (less than 5 MHz is FFS)

As an example, we can assume an operation such as the channel bandwidth of 10 MHz for the 1st carrier and that of 5 MHz for the adjacent carrier as shown in Figure 10.1.

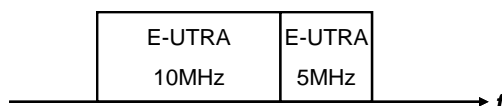

**Figure 10.1: multi-carrier BS of different E-UTRA channel bandwidths**

- multi-carrier BS of different E-UTRA and UTRA covering only 5 MHz and higher E-UTRA channel bandwidths (less than 5 MHz is FFS)

As an example, we can assume an operation such as E-UTRA with channel bandwidth of 5 MHz for 1st carrier and UTRA for adjacent carrier as shown in Figure 10.2.

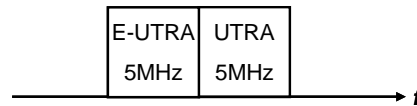

Figure 10.2: multi-carrier BS of E-UTRA and UTRA

- only multi-carrier BS with contiguous carriers are considered.
- the guidelines below assumes that the power spectral density of the multiple carriers is the same.

All other combinations of multiple carriers are ffs.

### 10.1.2 Multi-carrier BS of different E-UTRA channel bandwidths

Among the unwanted emissions, the transmitter spurious emissions requirements in [19] should be applied irrespective of channel bandwidth. Therefore, ACLR and Operating band unwanted emissions requirements for such a scenario of different channel bandwidths should be specified as follows:

For multi-carrier E-UTRA BS of different channel bandwidths ( $\geq 5$  MHz), the channel bandwidth of the outer most carrier in the operating band should be considered. That is, the corresponding requirements for the channel bandwidth of the outer most carrier should be applied at either side of the operating band as shown in Figure 10.3.

From a co-existence point of view, this guideline means that multi-carrier BS should not cause larger interference to adjacent systems than single carrier BS. From the specification's complexity point of view, this concept seems reasonable.

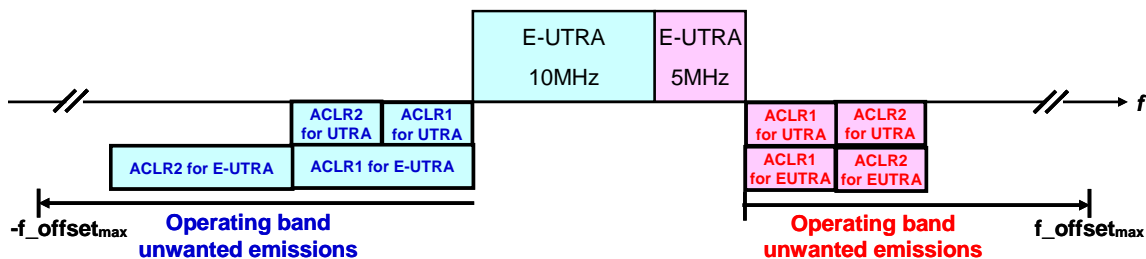

Figure 10.3: Unwanted emissions requirements for multi-carrier BS of different E-UTRA channel bandwidths

### 10.1.3 Multi-carrier BS of E-UTRA and UTRA

Among the unwanted emissions, the transmitter spurious emissions requirements in [19] should be applied for E-UTRA at frequencies within the specified frequency ranges, which are

- more than 10 MHz below the lowest frequency of the BS transmitter operating band if E-UTRA is the lowest carrier or
- more than 10 MHz above the highest frequency of the BS transmitter operating band if E-UTRA is the highest carrier.

Exceptions are the requirement in Table 6.6.4.3-2 and 6.6.4.3-3 of [19] that apply also closer than 10 MHz from operating band.

For UTRA, the transmitter spurious emissions requirements in [20] should be applied at frequencies within the specified frequency ranges, which are

- more than 12.5MHz below the first carrier used if UTRA is the lowest carrier or
- more than 12.5 MHz above the last carrier frequency used if UTRA is the highest carrier.

Exceptions are the requirement in Clause 6.6.3.5 and 6.6.3.8 of [20] that apply also closer than 12.5 MHz from the outermost carrier frequency used.

Furthermore, Spectrum emission mask (SEM) applies to a UTRA BS transmitting on single RF carrier [20]. Thus SEM should not be applied to multi-carrier BS of different RATs. Therefore, ACLR and Operating band unwanted emissions requirements for such a scenario with E-UTRA and UTRA should be specified as follows:

For multi-carrier BS of E-UTRA (channel bandwidth(s)  $\geq 5$  MHz) and UTRA, the RAT being used at the edge of the operating band should be considered. That is, the corresponding requirements for the RAT being used on the outer most carrier should be applied at either side of the operating band as shown in Figure 10.4.

From a co-existence point of view, this guideline means that multi-carrier BS should not cause larger interference to adjacent systems than single carrier BS. From the specification's complexity point of view, this concept seems reasonable.

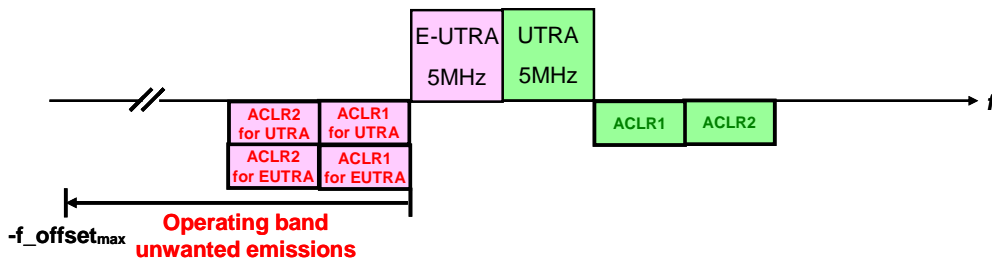

Figure 10.4: Unwanted emissions requirements for multi-carrier BS of E-UTRA and UTRA

## 10.2 Receiver requirements for multi-carrier BS

### 10.2.1 General

In a multi-carrier receiver, it is possible to set the processing bandwidth (i.e. used receiver BW) wider than a single E-UTRA channel bandwidth. Both TX and RX requirements in [19] are specified at the BS antenna connector. From this perspective there is a fundamental difference between a multi-carrier transmitter and a multi-carrier receiver. At the antenna connector, the “lowest carrier frequency used” and the “highest carrier frequency used” can be recognized via the emitted spectrum on the TX path. Therefore the same test set-up can be used for a single-carrier and a multi-carrier transmitter. However, on the RX path, as long as a test is performed with a single wanted carrier, it is impossible to identify at the antenna connector the lowest and the highest carrier frequency where *simultaneously* a certain performance is achieved. A multi-carrier receiver should therefore be tested with a multi-carrier wanted signal.

With a multi-carrier wanted signal, the same principles applied to multi-carrier TX testing can also be applied to RX testing. The manufacturer declares which frequency range and multi-carrier bandwidths that are supported. The lowest and the highest supported bandwidth are tested as specified in section 4.7 of TS 36.141[21]. A wanted signal is applied at the lower edge of the tested multi-carrier bandwidth. Another wanted signal is applied at the upper edge of the tested multi-carrier bandwidth. It is not deemed necessary to apply wanted signals between the outer carriers, because usually the worst performance is obtained at the outer channels. In the Reference sensitivity measurement only the two wanted signals are applied. In the ACS, blocking and intermodulation measurements interferers are applied at frequencies outside the tested multi-carrier bandwidth, with spacing as defined for each requirement in relation to the closest wanted signal respectively. Following the TX testing approach, no requirements are specified for interferers between the wanted channels.

Current specification allows the desensitization of the wanted signals in the presence of an interfering signal e.g., in the ACS test. It is FFS whether this desensitization should be consider further for multi-carrier case.

Regarding Dynamic range and In-channel selectivity, a similar approach as for the Reference sensitivity level can be adopted, i.e. two simultaneous wanted signals, one at the lowest assigned channel frequency and one at the highest assigned channel frequency are chosen, together with their corresponding in-channel interfering signals. That is to say, that the currently specified single carrier requirements should be simultaneously fulfilled at the lowest and highest assigned E-UTRA channel frequency.



## 10.2.2 Test principles for a multi-carrier BS of equal or different E-UTRA channel bandwidths

The following principles are proposed for receiver requirements in case of multi-carrier BS. Only 5 MHz and higher channel bandwidths are considered (less than 5 MHz is FFS):

- In a receiver that can receive multiple contiguous carrier over a declared multi-carrier bandwidth, two wanted carriers are tested simultaneously, at both edges of the multi-carrier bandwidth.
- There are no requirements for interfering signals between the wanted carriers.
- Only the highest and the lowest supported multi-carrier bandwidth are tested.
- The same set of interfering signals is used as in the equivalent single-carrier test. E.g. in a blocking test there is only one blocker at a time, even though two simultaneous wanted signals are used.
- The test is repeated for the lower and upper wanted signals, with the interfering signals below the lower and above the higher wanted signal respectively. The properties of the interferer(s) are chosen according to the requirements of the closest wanted signal.
- For the receiver tests the desensitization for the wanted signals should be the same as for the single carrier case.

---

# 11 Rationale for unwanted emission specifications

Unwanted emissions are divided into “Out-of-band emission” and “Spurious emissions” in 3GPP RF specifications. This notation is in line with ITU-R recommendations such as SM.329 [22] and the Radio Regulations [23]. ITU defines:

**Out-of-band emission** = Emission on a frequency or frequencies immediately outside the necessary bandwidth which results from the modulation process, but excluding spurious emissions.

**Spurious emission** = Emission on a frequency, or frequencies, which are outside the necessary bandwidth and the level of which may be reduced without affecting the corresponding transmission of information. Spurious emissions include harmonic emissions, parasitic emissions, intermodulation products and frequency conversion products but exclude out-of-band emissions.

**Unwanted emissions** = Consist of spurious emissions and out-of-band emissions.

Some requirements in [19] may only apply in certain regions either as optional requirements or set by local and regional regulation as mandatory requirements. It is normally not stated in the 3GPP specifications under what exact circumstances the requirements apply, since this is defined by local or regional regulation.

All requirements that may be applied differently in different regions are listed in [19] Clause 4.3.

## 11.1 Out of band Emissions

Out of band emissions are unwanted emissions immediately outside the channel bandwidth resulting from the modulation process and non-linearity in the transmitter but excluding spurious emissions. This out of band emission requirement is specified both in terms of operating band unwanted emissions and adjacent channel power ratio (ACLR) for the transmitter. ACLR is specified mainly as a measure of the capability of the transmitter to guarantee the interfering signal below an acceptable level to the adjacent system to allow co-existence. ACLR is also a regulatory requirement in certain countries. Operating band unwanted emissions is specified mainly as a measure of the capability of the transmitter to comply with certain regional regulatory requirements.

### 11.1.1 Operating band unwanted emission requirements for E-UTRA BS (spectrum emission mask)

E-UTRA should have a operating band unwanted emissions (spectrum emissions mask, SEM) requirements defined, based on the following prerequisites.

- SEM should be defined with a reference bandwidth of 100 kHz.
- The SEM limit should also be set to allow some variations due to varying power allocation between resource blocks.

- FCC requirements [25] which apply mainly in Region 2 should be defined separately as an absolute limit and may need a smaller reference bandwidth in some cases.
- In UTRA, the spectrum emissions mask is not only defined in the OOB domain, but also across the spurious domain inside the operating band. This can also be the case for the E-UTRA mask, as long as the limits in the spurious domain are consistent with recommended spurious limits in SM.329 [22]. The “unified” in-band OOB + spurious emissions for E-UTRA can be named “*unwanted emissions*” which is the agreed terminology [25] that encompasses both OOB and spurious emissions.
- The SEM limit should apply for both single and multi-carrier BS.
- FCC requirements as defined in [25] apply for bands 2, 4, 5, 10, 12, 13, 14, 17, 35 and 36 as additional limits.

The Operating band unwanted emission limits are defined as a “mask” that stretches from 10 MHz below the lowest frequency of the BS transmitter operating band up to 10 MHz above the highest frequency of the BS transmitter operating band, as shown in Figure 11.1. Parts of the mask will be in the out-of-band domain (within +/-2.5 times the necessary bandwidth of the carrier) and parts will be in the spurious domain..

The unwanted emission limit in the part of the operating band that falls in the spurious domain must be consistent with SM.329 [22]. Based on the Category B spurious emission limits in [22] a level of -25 dBm in 100 kHz (-15 dBm in 1 MHz) is selected as the lower bound for the unwanted emission limits. This is consistent with the level used for UTRA as spurious emission limit inside the operating band. Further details on the spurious emission limits and their interpretation for UTRA (and E-UTRA) are given in TR 25.942 [3], clause 14.2.

For E-UTRA Bands 2, 4, 5, 10, 12, 13, 14, 17, 35, 36, an additional Un wanted emission limit is derived from FCC Title 47 [25] Parts 22, 24 and 27. The requirement stated in [25] is interpreted as -13 dBm in a measurement bandwidth defined as 1% of the “-26 dB modulation bandwidth”. For the E-UTRA channel bandwidths, the following additional requirements are defined:

- **1.4 MHz channel bandwidth:** -14 dBm in 10 kHz, which assumes that the “-26 dB modulation bandwidth” is < 1.26 MHz.
- **3 MHz channel bandwidth:** -13 dBm in 30 kHz, which assumes that the “-26 dB modulation bandwidth” is < 3.0 MHz.
- **5 MHz channel bandwidth:** -15 dBm in 30 kHz, which assumes that the “-26 dB modulation bandwidth” is < 4.75 MHz.
- **10 MHz channel bandwidth:** -13 dBm in 100 kHz, which assumes that the “-26 dB modulation bandwidth” is < 10 MHz.
- **15 MHz channel bandwidth:** -15 dBm in 100 kHz, which assumes that the “-26 dB modulation bandwidth” is < 15.8 MHz.
- **20 MHz channel bandwidth:** -16 dBm in 100 kHz, which assumes that the “-26 dB modulation bandwidth” is < 20 MHz.

The additional limit outside the first MHz adjacent to the channel bandwidth, for all channel bandwidths, is -13dBm/100kHz for E-UTRA Bands 5, 12, 13, 14, 17, and -13dBm/1MHz for E-UTRA Bands 2, 4, 10, 35 and 36.

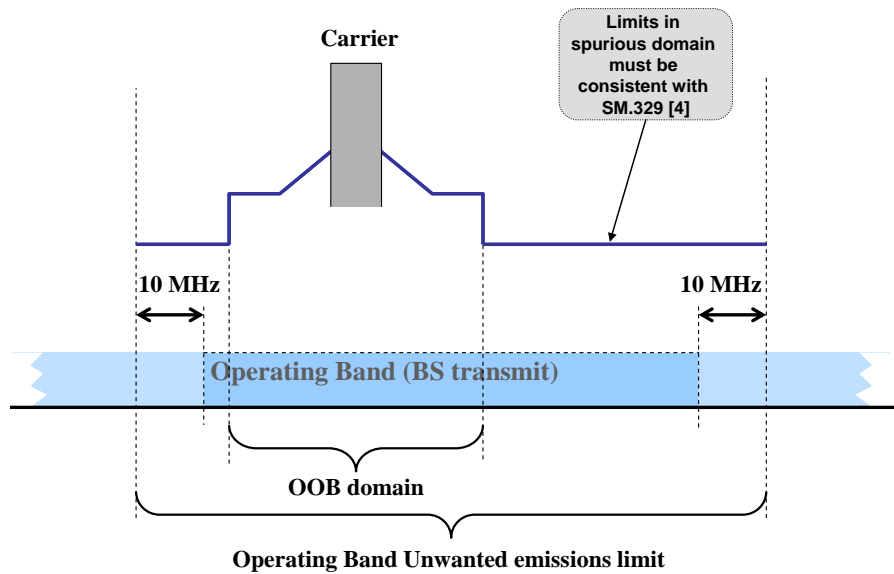

**Figure 11.1 Defined frequency range for Operating band unwanted emissions with an example RF carrier and related mask shape.**

The requirements shall apply whatever the type of transmitter considered (single carrier or multi-carrier). It applies for all transmission modes foreseen by the manufacturer's specification.

Emissions shall not exceed the maximum level specified in [19] for [any] BS maximum output power, where:

- $\Delta f$  is the separation between the channel edge frequency and the nominal -3dB point of the measuring filter closest to the carrier frequency.
- $f_{\text{offset}}$  is the separation between the channel edge frequency and the centre of the measuring filter.
- $f_{\text{offset}_{\text{max}}}$  is the offset to the frequency 10 MHz outside the operating band edge.
- $\Delta f_{\text{max}}$  is equal to  $f_{\text{offset}_{\text{max}}}$  minus half of the bandwidth of the measuring filter.

Minimum BS requirements for Category A and Category B are specified in [19].

## 11.1.2 ACLR requirements for E-UTRA BS

If there is to be both an ACLR-type requirement with carrier-wide reference bandwidth and a mask (SEM) with much narrower reference bandwidth, the ACLR limit should be somewhat stricter than the integrated SEM. In this way, the ACLR can capture the “average” behaviour over a carrier, while the SEM can take into account the variations in the spectrum emissions resulting from variations in power allocations.

Since it is important to assess sharing properties both with adjacent UTRA systems and with E-UTRA carriers the ACLR is defined with different bandwidths:

- ACLR/UTRA in a 1st and 2nd adjacent channel with 5 MHz and/or 1.6 MHz reference bandwidth depending on paired or unpaired spectrum.
- ACLR/E-UTRA (reference bandwidth equal to E-UTRA channel bandwidth) in a 1st and 2nd adjacent channel.
- For carriers with channel bandwidth larger than 5 MHz positioned close to or adjacent to the band edge, the 1<sup>st</sup> or 2<sup>nd</sup> adjacent channel that define the ACLR/E-UTRA may fall partly or fully outside the point 10 MHz from the band edge. If it is fully outside, it should not be defined. If it is partly outside it can still be defined, but may not be limiting compared to the unwanted emission limits defined by SEM and spurious emissions.
- ACLR should apply for both single and multi-carrier BS.

ACLR measured in other reference bandwidths (smaller or larger) than the E-UTRA carrier or 5 MHz are indirectly defined by the mask.

ACLR is defined for two cases as shown in Figure 11.2, i.e. for 1<sup>st</sup> and 2<sup>nd</sup> adjacent E-UTRA carriers of the same bandwidth and for 1<sup>st</sup> and 2<sup>nd</sup> adjacent UTRA carriers. Separate limits are defined for each channel bandwidth. The requirements can be stated with two tables, one for adjacent E-UTRA and one for adjacent UTRA.

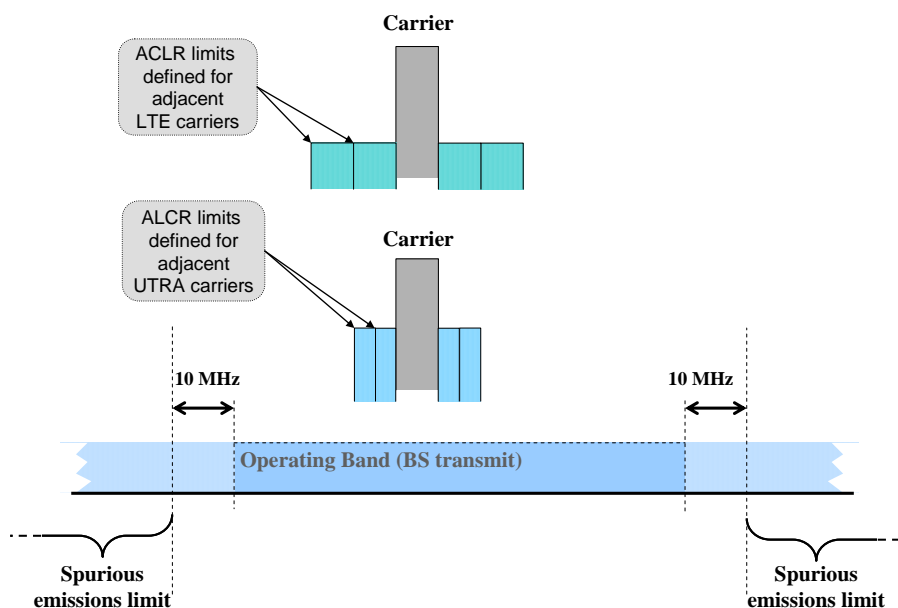

**Figure 11.2 The two defined ACLR measures, one for 1<sup>st</sup> and 2<sup>nd</sup> adjacent E-UTRA carriers and one for 1<sup>st</sup> and 2<sup>nd</sup> adjacent UTRA carrier.**

Minimum BS requirements for Category A and Category B are specified in [19]. BS ACLR requirements are captured for E-UTRA operating in paired spectrum and in unpaired spectrum. For Category A, either the limits in [19] or the absolute limit of -13dBm/MHz (Note 2) apply, whatever is less stringent. For Category B, the numbers are based on the co-existence simulations outlined in this TR 36.942. Either the limits in [19] or the absolute limit of -15dBm/MHz apply, whatever is less stringent.

NOTE: Whether the absolute limit is applicable to other base station classes is ffs.

NOTE2 Since the limits -13 dBm and -15 dBm are regulatory requirements taken from Category A and B spurious emissions respectively, the test requirement shall also be -13dBm and -15 dBm respectively, i.e. the test tolerance shall be zero when deriving the test limit.

The ACLR2 for the UTRA is set to be the same as ACLR1. It was revealed in [26] and [27] that the second adjacent channel interference contributes only little to overall ACIR because ACLR/ACS in the second adjacent channel is significantly higher than the UTRA UE ACS1.

It was pointed out in [28] that an E-UTRA BSs must not cause larger interference (in terms of absolute power) to the co-existing UTRA system than the one allowed in the current 3GPP requirements, irrespective of its channel bandwidth.

For the deployment in Japan, additional spurious emission requirement to protect co-existing (domestic) wireless systems may be required for certain bands (i.e. E-UTRA Band 1, 6, 9, and 11) in order to limit the ACI in 10, 15, and 20 MHz Channel BW options.

The measurement filter for the transmitted E-UTRA carrier and the adjacent E-UTRA carrier is a rectangular filter with a bandwidth equal to the transmission bandwidth configuration  $N_{RB} \cdot 180$  kHz. For ACLR/UTRA, the power of the adjacent carrier is measured using an RRC filter with roll-off factor  $\alpha = 0.22$ .

Adjacent Channel Leakage power Ratio (ACLR) is the ratio of the filtered mean power centered on the assigned channel frequency to the filtered mean power centred on an adjacent channel frequency.

The requirements shall apply whatever the type of transmitter considered (single carrier or multi-carrier). It applies for all transmission modes foreseen by the manufacturer's specification.

## 11.2 Spurious emissions

### 11.2.1 BS Spurious emissions

Spurious emissions are defined in ITU-R Radio Regulations [23] and SM.329 [22].

The UTRA core requirements for spurious emissions are specified for the BS in TS 25.104 [20].

References for the spurious emissions requirements are summarised in Table 11.1 for the BS. The tables give references to RAN4 core specs, to where the term is defined and to some relevant regulatory references. These regulatory references have either defined the limit value in 3GPP or they have used it as a basis for studies or recommendations.

**Table 11.1 Summary of regulatory references for BS spurious emissions limits.**

Spurious emissions requirement	RAN4 TS 25.104 [20]	Definition	Some relevant regulatory references
General	6.6.3.1	ITU-R SM.329 [22]	ITU-R M.1580 (Annex 1.4) [29]: Band I limits included. ITU-R SM.329[22]: 1.4 Necessary bandwidth 4.1 Reference bandwidths 4.2 Category A limits 4.3 Category B limits Annex 7. Reference BW (Cat. B) ITU-R M.2039 [30]: Limits included by reference. ETSI EN 301 908-3 [31]: Category B limits included.
Co-existence with other bands	6.6.3.2 to 6.6.3.7	Developed and defined in 3GPP.	ITU-R M.1580 (Annex 1.4) [29]: Band I limits included. ITU-R. M.2039 [30]: Limits included by reference. ETSI EN 301 908-3 [31]: Limits to protect GSM900 and GSM1800 in the same area included.

### 11.2.2 General spurious emissions requirements for E-UTRA BS

The definition of “Operating band unwanted emissions” for E-UTRA covers not only the OOB domain, but also the spurious domain inside the operating band, including the 10 MHz of spectrum immediately above and below the operating band. For that reason, there is no need to define spurious emission limits inside the operating band as shown in Figure 11.3. The implication is that the rule that spurious emissions start at a point separated from the carrier centre by 250% of the necessary bandwidth is not applied. Note however that since parts of the Operating band unwanted emission limits will fall inside the spurious domain, they are bound by the same regulatory limits that define spurious emissions. The operating band unwanted emission limits are further discussed in Clause 11.1.1.

Since the spurious emission limits defined here does not cover the frequency range of the spurious domain inside the operating band, they should be named “Spurious emissions outside the operating band”, in order to distinguish them from the definition of spurious emissions in the spurious domain in ITU-R SM.329 [22].

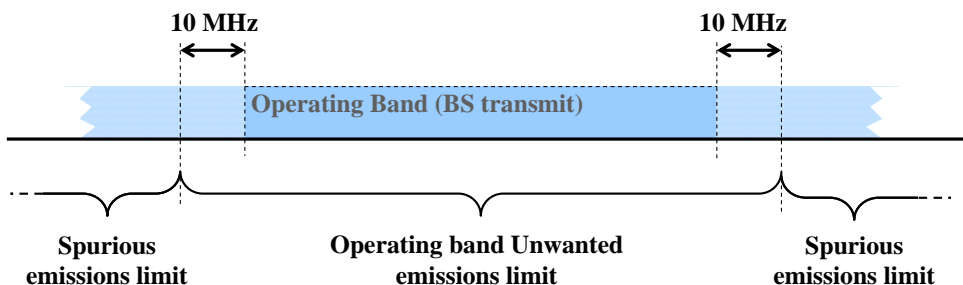

**Figure 11.3 Defined frequency ranges for spurious emissions and operating band unwanted emissions**

Spurious emission limits as defined in ITU-R SM.329[22] are divided into several Categories, where Category A and B are applied for 3GPP as regional requirements. The Category A and Category B spurious emission limits in Tables 11.2 and 11.3 are in line with ITU-R SM.329[22]. They would apply outside of the region where the limits for “Operating

band unwanted emissions” are defined (operating band plus 10 MHz on each side). Further details on the spurious emission limits and their interpretation for UTRA (and E-UTRA) are given in TR 25.942 [3], clause 14.2.

### 11.2.3 Specification of BS Spurious emissions outside the operating band

The spurious emission limits (except the protection of PHS and Public Safety operations) apply in frequency ranges that are more than 10 MHz below the lowest BS transmitter frequency of the operating band and more than 10 MHz above the highest BS transmitter frequency of the operating band. The requirements shall apply whatever the type of transmitter considered (single carrier or multi-carrier). It applies for all transmission modes foreseen by the manufacturer's specification.

**Table 11.2: BS Spurious emission limits outside the operating band, Category A**

Band	Maximum level	Measurement Bandwidth	Note
9kHz - 150kHz	-13 dBm	1 kHz	Note 1
150kHz - 30MHz		10 kHz	Note 1
30MHz - 1GHz		100 kHz	Note 1
1GHz - 12.75 GHz		1 MHz	Note 2
NOTE 1: Bandwidth as in ITU-R SM.329 [22] , s4.1			
NOTE 2: Bandwidth as in ITU-R SM.329 [22] , s4.1. Upper frequency as in ITU-R SM.329 [22] , s2.5 table 1			

**Table 11.3: BS Spurious emissions limits outside the operating band, Category B**

Band	Maximum Level	Measurement Bandwidth	Note
9 kHz ↔ 150 kHz	-36 dBm	1 kHz	Note 1
150 kHz ↔ 30 MHz	-36 dBm	10 kHz	Note 1
30 MHz ↔ 1 GHz	-36 dBm	100 kHz	Note 1
1 GHz ↔ 12.75 GHz	-30 dBm	1 MHz	Note 2
NOTE 1: Bandwidth as in ITU-R SM.329 [22] , s4.1			
NOTE 2: Bandwidth as in ITU-R SM.329 [22] , s4.1. Upper frequency as in ITU-R SM.329 [22] , s2.5 table 1			

Minimum BS spurious emissions requirements are specified in [19] including Category A, Category B, protection of the BS receiver of own or different BS, co-existence with other systems in the same geographical area, limits for BS in geographic coverage area of PHS, limits for protection of public safety operations and co-location with other base stations.

BS Spurious emissions limits for BS co-located with another BS in [19] do not apply for the 10 MHz frequency range immediately outside the BS transmit frequency range of an operating band. This is also the case when the transmit frequency range is adjacent to the Band for the co-location requirement. The current state-of-the-art technology does not allow a single generic solution for co-location with other system on adjacent frequencies for 30dB BS-BS minimum coupling loss. However, there are certain site-engineering solutions that can be used. These techniques are addressed in TR 25.942 [3].

### 11.2.4 Additional spurious emissions requirements

These requirements may be applied for the protection of system operating in frequency ranges other than the E-UTRA BS operating band. The limits may apply as an optional protection of such systems that are deployed in the same geographical area as the E-UTRA BS, or they may be set by local or regional regulation as a mandatory requirement for an E-UTRA operating band. It is in some cases not stated in [19] whether a requirement is mandatory or under what exact circumstances that a limit applies, since this is set by local or regional regulation. An overview of regional requirements is given in [19] Clause 4.3.

## 12 LTE-Advanced co-existence

### 12.1 Methodology and simulation assumptions for co-existence simulations

This section describes the method of used for LTE-Advanced co-existence study to focus the modified methodology and assumptions.

#### 12.1.1 Simulation scenarios

Table 12.1 and Table 12.2 show the simulation scenario for LTE-Advanced coexistence and BS/UE model for LTE-A coexistence evaluation respectively.

**Table 12.1: Simulation scenarios for LTE-Advanced coexistence**

Scenario #	Aggressor system	Victim system	Simulation frequency	Environment	ISD	Cell Range	Priority
1	DL: 40 MHz, UL: 40 MHz LTE-A	10 MHz LTE	2000 MHz	Urban Area	750 m	500 m	High
2	DL: 40 MHz, UL: 40 MHz LTE-A	DL: 40 MHz, UL: 40 MHz LTE-A	2000 MHz	Urban Area	750 m	500 m	High
3	DL: 40 MHz, UL: 40 MHz LTE-A	5 MHz UTRA FDD	2000 MHz	Urban Area	750 m	500 m	High
4	DL: 40 MHz, UL: 40 MHz LTE-A	1.6MHz UTRA TDD	2000 MHz	Urban Area	750 m	500 m	High

**Table 12.2 BS and UE model for LTE-A coexistence**

Parameters	Assumptions
Deployment scenario	Macro cell, Urban area, Uncoordinated deployment
Total BS transmit power	43 dBm for UTRA FDD, 34 dBm for UTRA TDD, 46 dBm for 10 MHz LTE, 49 dBm for 40 MHz LTE-A
BS noise figure	5 dB
UE Tx power	21 dBm for 5MHz UTRA, 24dBm for 1.6MHz UTRA 23 dBm for 10 MHz LTE/ 40MHz LTE-A
UE noise figure	9 dB

#### 12.1.2 Number of UEs per sub-frame

For downlink, the number of UEs per sub-frame would not affect the simulation results, because the total transmission power for the system would be constant. The number of UEs per sub-frame for downlink is presented in Table 12.3.

**Table 12.3 Number of UEs per sub-frame for downlink**

System	Number of UEs per subframe	Number of RBs per UE
LTE	1 UEs	50 RBs
LTE-Advanced	1 UEs	200 RBs

For uplink, the number of UEs per sub-frame might affect the simulation results, because the total transmission power for the system would depend on the number of UEs per sub-frame. Since the number of resource blocks for one UE would be typically 8~16 in the actual UL scheduler, it is proposed that the number of UEs per sub-frame is calculated as follows:

$$(\text{Number of UEs per sub-frame}) = \text{round down} ((\text{Total number of RBs for the system}) / 16)$$

The number of UEs per sub-frame for uplink is presented in Table 12.4.

**Table 12.4 Number of UEs per sub-frame for uplink**

System	Number of UEs per subframe	Number of RBs per UE
LTE	3 UEs	16 RBs (Total: 48 RBs)
LTE-Advanced	12 UEs	16 RBs (Total: 192 RBs)

Note: The resource block size should be 180 kHz instead of 375 kHz.

### 12.1.3 ACIR model

The ACIR is defined as the ratio of the total power transmitted from an aggressor transmitter (BS or UE) to the total interference power affecting a victim receiver, resulting from both transmitter and receiver imperfections. Thus,  $ACIR = P_{\text{aggressor}} - P_{\text{victim}}$  (all in dB), where  $P_{\text{aggressor}}$  is the transmit power of an aggressor and  $P_{\text{victim}}$  is the interference power at the victim receiver.

#### 12.1.3.1 Uplink ACIR model

For uplink, it is assumed that the ACIR is dominated by the UE ACLR. As shown in Figure 12.1 and Table 12.5, the bandwidth for each ACIR value was assumed to be the same as the transmission bandwidth of LTE-A UE. Outside ACIR1/2 regions, ACIR3 was used for all the regions. Those models are modified model, in which the ACIR3 is smaller than ACIR2 based on the actual spectrum shape.

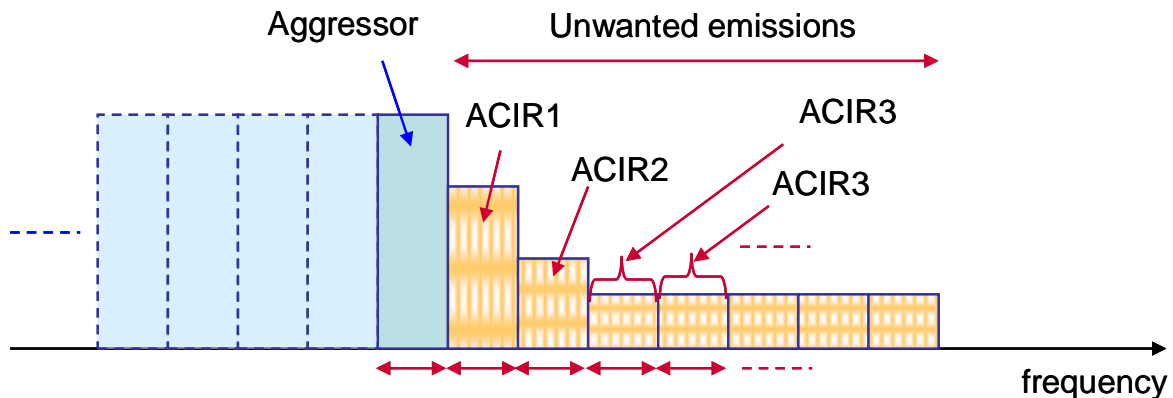

**Figure 12.1 Uplink ACIR models**

**Table 12.5 ACIR models for LTE-A coexistence**

	ACIR value	(Ref. LTE model)
ACIR1	30 + X	30 + X
ACIR2	43 + X	43 + X
ACIR3	50 + X	43 + X

The bandwidth of victim UEs are same that of aggressor UEs in Scenario #1 and #2 (victim in LTE or LTE-Advanced). ACIR value could be calculated from uplink ACIR model shown in table 12.6.



**Table 12.6 ACIR value for Scenario#1 and #2**

Frequency offset between aggressor (16 RBs) and victim (16RBs)	ACIR value
0 RBs	30 + X
16 RBs	43 + X
≥32RBs	50 + X

For Scenario #3 (3.84 MHz UTRA victim), the bandwidth of victim UEs are larger than that of aggressor UEs (2.88 MHz = 180 kHz x 16 RBs). As shown in figure 12.2, 12.3 and 12.4, victim UE suffer from the interference composed by two ACIR regions from an aggressor UE in asymmetrical bandwidths case. Based on the method described in 5.1.1.4.2, ACIR value from a UE could be calculated as shown in table 12.7.

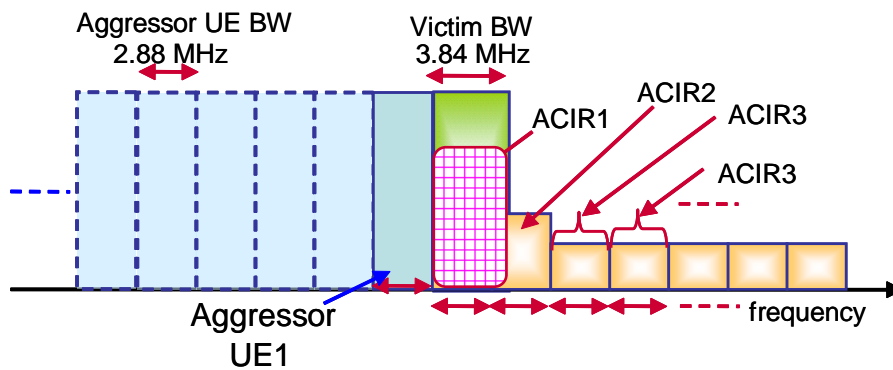

**Figure 12.2 Uplink ACIR models from aggressor UE1 for LTE-A vs. UTRA case**

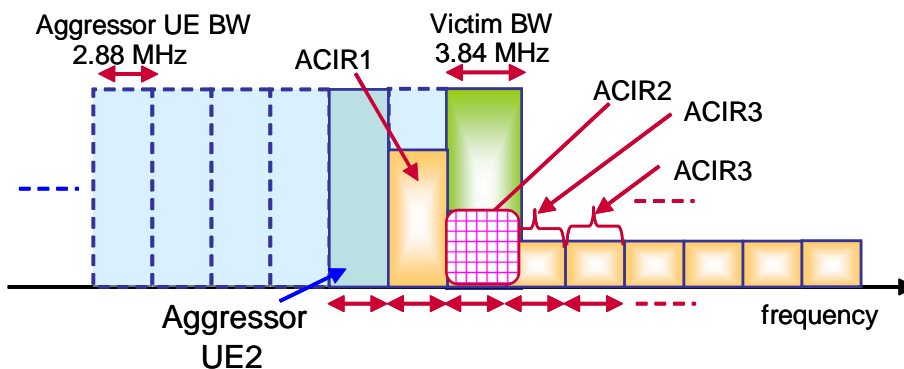

**Figure 12.3 Uplink ACIR models from aggressor UE2 for LTE-A vs. UTRA case**

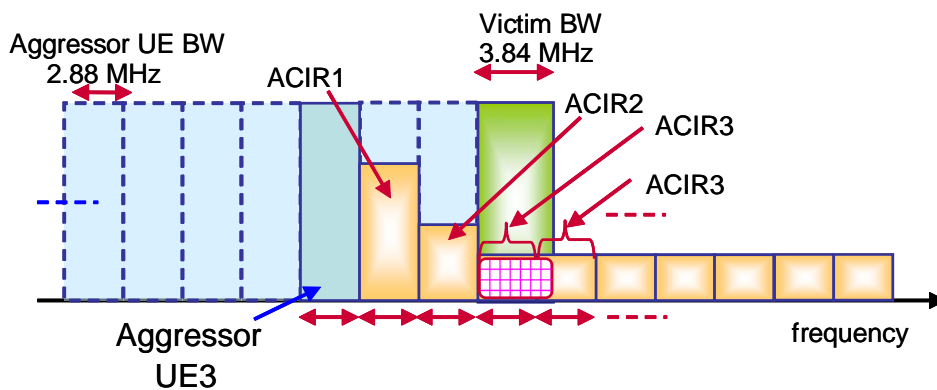
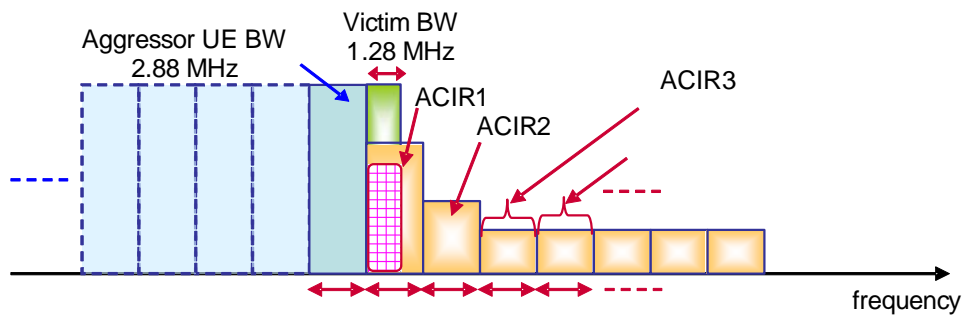

**Figure 12.4 Uplink ACIR models from aggressor UE3 for LTE-A vs. UTRA case**

**Table 12.7 ACIR value for Scenario#3**

Frequency offset between aggressor (16 RBs) and victim (16RBs)	ACIR value
0 RBs	30 + X
16 RBs	43 + X
≥32RBs	49 + X

For Scenario #4 (1.28 MHz UTRA victim), the bandwidth of victim UEs are smaller than that of aggressor UEs (2.88 MHz = 180 kHz x 16 RBs). As shown in figure 12.5, 12.6 and 12.7, victim UE suffer from the interference one ACIR region from an aggressor UE. Based on the method described in 5.1.1.4.2, ACIR value from a UE could be calculated as shown in table 12.8.



**Figure 12.5 Uplink ACIR models from aggressor UE1 for LTE-A vs. UTRA case**

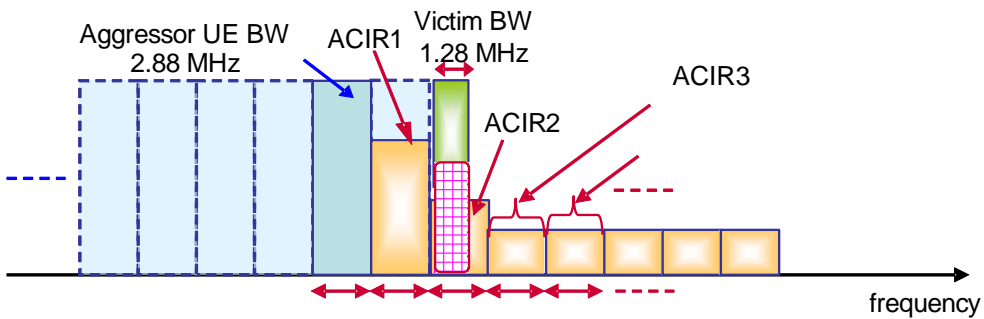

**Figure 12.6 Uplink ACIR models from aggressor UE2 for LTE-A vs. UTRA case**

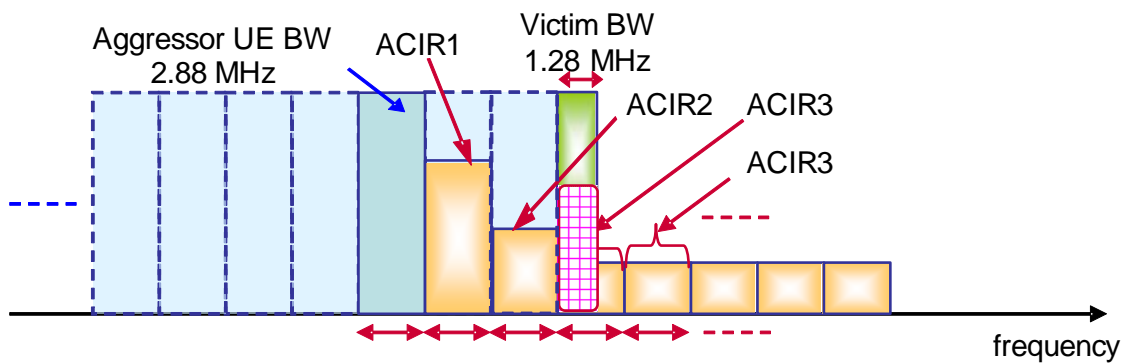

**Figure 12.7 Uplink ACIR models from aggressor UE3 for LTE-A vs. UTRA case**

**Table 12.8 ACIR value for Scenario#4**

Frequency offset between aggressor (16 RBs) and victim (16RBs)	ACIR value
0 RBs	33.5 + X
16 RBs	46.5+X
≥32RBs	53.5+X

12.1.3.2 Downlink ACIR model

For downlink a common ACIR obtained from the LTE-A BS ACLR and the victim UE ACS requirements can be used for all frequency resource blocks independent of their position in the aggressor channel. The ACLR of the LTE-A BS is much bigger than the ACS of the victim ACS and therefore has negligible impact on ACIR performance. In other words, the BS ACLR can be assumed as infinite and ACIR is only a function of the victim UE ACS, which can be mathematically described as ACIR = Average + X (in dB), where X is an offset relative to the “Average”. For Scenarios 1 and 3, the “Average” is determined from the UE ACS requirements (ACS1, ACS2 and ACS3) according to the respective specifications by the following relation (all parameters in dB):

$$\frac{1}{10^{0.1 \cdot \text{Average}}} = \frac{1}{40} * \left( \frac{5}{10^{0.1 \cdot \text{ACS1}}} + \frac{5}{10^{0.1 \cdot \text{ACS2}}} + \frac{30}{10^{0.1 \cdot \text{ACS3}}} \right)$$

For Scenario 2, the “Average” is based on an assumption for the 40 MHz LTE-A ACS.

For Scenarios 4, the “Average” is determined from the UE ACS requirements (ACS1, ACS2 and ACS3) according to the respective specifications by the following relation (all parameters in dB):

$$\frac{1}{10^{0.1 \cdot \text{Average}}} = \frac{1}{40} * \left( \frac{1.6}{10^{0.1 \cdot \text{ACS1}}} + \frac{1.6}{10^{0.1 \cdot \text{ACS2}}} + \frac{36.8}{10^{0.1 \cdot \text{ACS3}}} \right)$$

As shown in figure 12.8, figure 12.9, figure 12.10 and table 12.9, the ACIR offset calculated from the victim UE performance in TR25.101 for UTRA and TR36.101 for LTE of UE ACS.

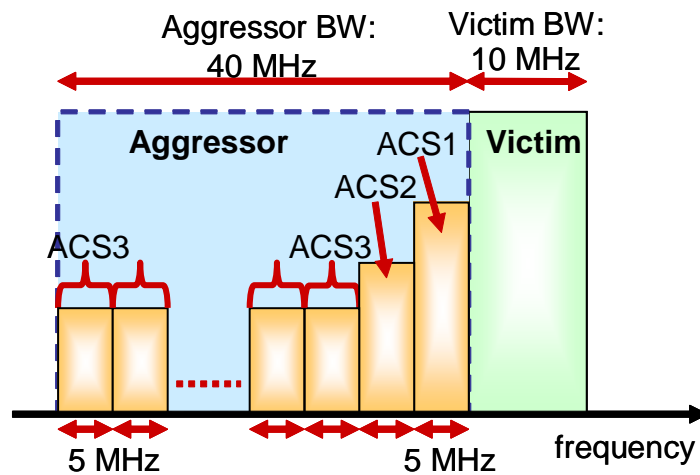

**Figure 12.8 Downlink ACIR model for Scenario #1**

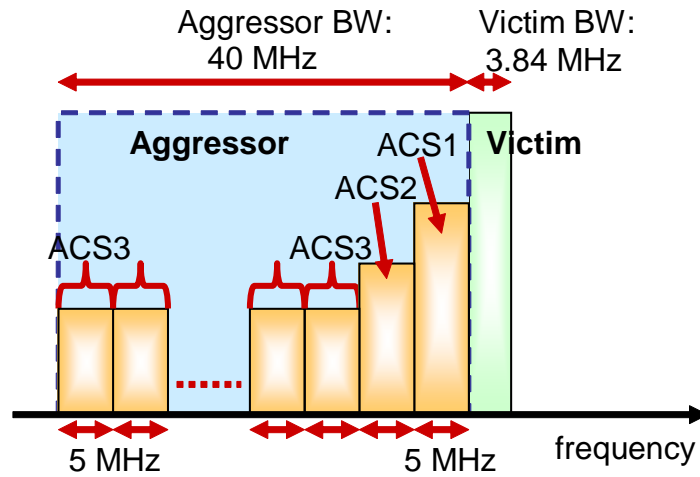

Figure 12.9 Downlink ACIR model for Scenario #3

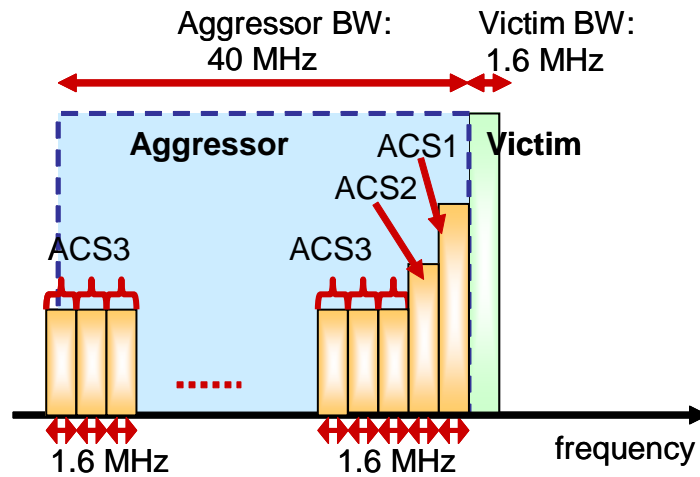

Figure 12.10 Downlink ACIR model for Scenario #4

Table 12.9 ACS and ACIR value for LTE-A coexistence

	Victim system			
	10 MHz LTE	40 MHz LTE-A	5 MHz UTRA	1.6 MHz UTRA
ACS1 [dB]	33.0	—	33.0	33.0
ACS2 [dB]	34.3	—	43.0	43.0
ACS3 [dB]	46.3	—	55.0	55.0
ACIR [dB]	39 + X	30 + X	42 + X	46 + X

### 12.1.4 Uplink power control

For downlink, no power control scheme is applied and the transmission power per RB should be constant.

For LTE coexistence study, the fractional power control was used for the initial uplink coexistence simulations. It is noted that the parameter CL<sub>x</sub>-ile in the table below is the same for both 40 MHz and 10 MHz systems because it is assumed that each UE is assigned 16 RBs in either system.

Table 12.10 Power control algorithm parameter of LTE coexistence

Parameter Set	Gamma	CL <sub>x-ile</sub>	
		40MHz	10MHz
Set 1	1	112- $\Delta$	112- $\Delta$
Set 2	0.8	129- $\Delta$	129- $\Delta$
Note: $\Delta = 21 \log_{10}(f_c / 2.0)$ , adjustment parameter related to different carrier frequency point. For $f_c=2\text{GHz}$ , $\Delta = 0\text{dB}$ .			

In RAN1 TS36.213, The setting of the UE Transmit power  $P_{\text{PUSCH}}$  for the physical uplink shared channel (PUSCH) transmission in subframe  $i$  is defined by:

$$P_{\text{PUSCH}}(i) = \min(P_{\text{CMAX}}, 10 \log_{10}(M_{\text{PUSCH}}(i)) + P_{\text{O\_PUSCH}}(j) + \alpha(j) \cdot PL + \Delta_{\text{TF}}(i) + f(i))$$

Note 1:  $\Delta_{\text{TF}}(i) = 0 \text{ dB}$ ,  $f(i) = 0 \text{ dB}$ , and  $PL$  in the above equation is equivalent to  $CL$  defined in TR 36.942 Section 5.1.1.6.

Note 2:  $P_{\text{O\_PUSCH}}(j)$  should be derived from  $CL_{\text{x-ile}}$  so that the actual transmission power should be the same as the one for PC Set 1/2. Following this principle,  $P_{\text{O\_PUSCH}}(j)$  can be obtained and included in the table below, assuming each UE occupies 16RBs (as shown in Section 12.1.2):

**Table 12.11**  $P_{\text{O\_PUSCH}}(j)$  value (in dBm)

Parameter Set	Alpha	$P_{\text{O\_PUSCH}}(j)$ [dBm]	
		40 MHz (LTE-A)	10 MHz (LTE)
Set 1	1	-101	-101
Set 2	0.8	-92.2	-92.2

Note that when calculating  $P_{\text{O\_PUSCH}}(j)$ , it is assumed that  $P_{\text{CMAX}}$  is equal to  $P_{\text{PowerClass}}$ . In other words, no MPR, A-MPR or power tolerances are considered for simplicity.

## 12.2 Results

### 12.2.1 Radio reception and transmission

#### 12.2.1.1 ACIR Downlink 40 MHz Advanced E-UTRA interferer – 10 MHz E-UTRA victim

Simulations are based on the following assumptions:

Aggressor system:	40 MHz Advanced E-UTRA
Victim system:	10 MHz E-UTRA
Simulation frequency:	2000 MHz
Environment:	Macro Cell, Urban Area, uncoordinated deployment
Cell Range	500 m

Simulation results for average E-UTRA downlink cell throughput loss are presented in table 12.12 and figure 12.11. Simulation results for 5% CDF E-UTRA downlink user throughput loss are presented in table 12.13 and figure 12.12.

Table 12.12 average E-UTRA downlink throughput loss

ACIR offset X [dB]	average	Qualcomm (R4-102147)	LGE (R4-101144)	NTT DOCOMO (R4-101350)	Huawei (R4-101353)	Alcatel-Lucent (R4-101114)	CATT (R4-101173)	CMC (R4-101278)	CATR (R4-101589)	ZTE (R4-101700)	Samsung (R4-101842)	Motorola (R4-102076)
-25	17.6		15.3	20.2				17.3				
-20	9.9		8.1	11.2	9.99		11.17	9.2	10.26	8.81	10.7	
-15	5.1		3.8	5.8	4.94	5.8	5.79	4.4	5.38	4.79	5.3	
-10	2.6	2.8	1.6	2.8	2.18	2.7	2.82	2.1	2.57	2.35	2.4	4.2
-5	1.1	1.3	0.6	1.2	0.85	1.1	1.22	0.8	1.14	1.06	1	1.8
0	0.4	0.56	0.2	0.5	0.29	0.4	0.53	0.4	0.46	0.44	0.4	0.7
5	0.2	0.24	0.1	0.2	0.1	0.2	0.19	0.1	0.17	0.17	0.1	0.25
10	0.1	0.09		0.1	0.032	0.1	0.09		0.05	0.06	0.1	0.07
15	0.0			0.0	0.01	0				0.02	0	

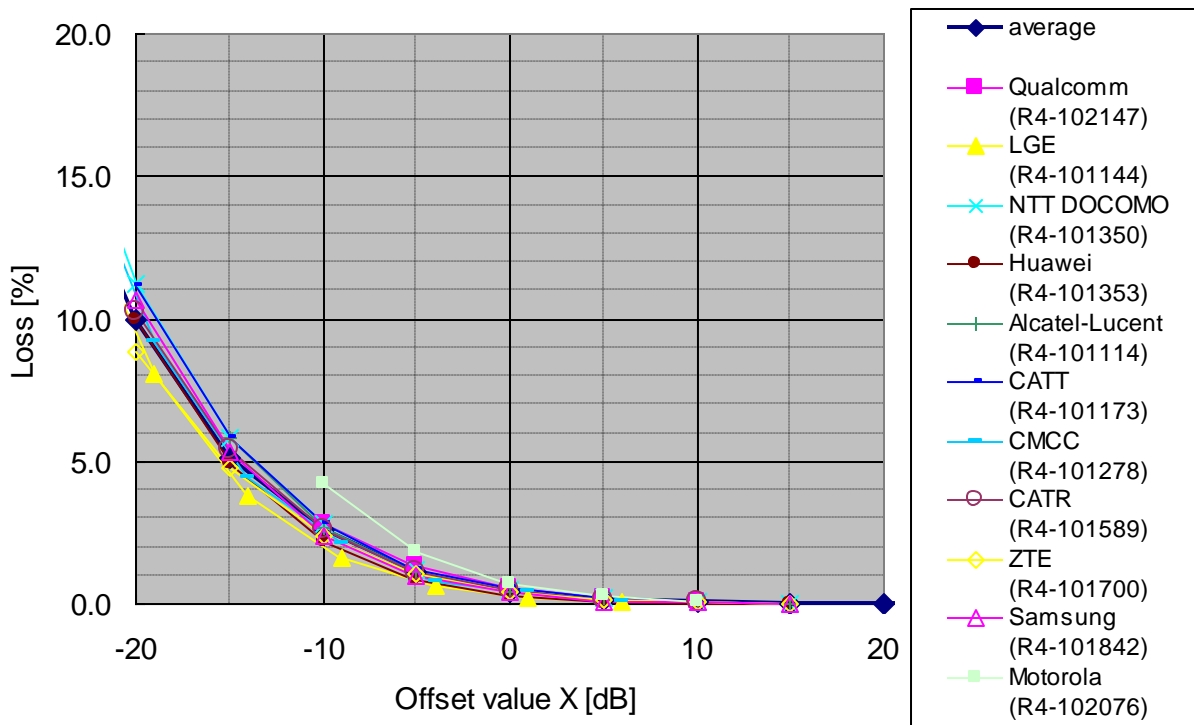

Figure 12.11 average E-UTRA downlink throughput loss

Table 12.13 5%-ile E-UTRA downlink throughput loss

ACIR Offset X [dB]	average	Qualcomm (R4-102147)	LGE (R4-101144)	NTT DOCOMO (R4-101350)	Huawei (R4-101353)	Alcatel-Lucent (R4-101114)	CATT (R4-101173)	CMC (R4-101278)	CATR (R4-101589)	ZTE (R4-101700)	Samsung (R4-101842)	Motorola (R4-102076)
-25	83.0		70.8	100.0				78.3				
-20	47.8		37.3	47.1	100		52.29	40.4	44.74	21.68	39.1	
-15	22.0		16.2	23.4	46.54	18.2	24.17	18.7	23.52	8.05	18.8	

-10	8.9	11.5	6.2	10.6	11.65	7.7	10.7	8.2	10.93	2.69	7.9	10.3
-5	3.4	4.6	2.1	5.0	2.81	1.4	5.33	3.2	4.7	0.87	3.2	4.5
0	1.3	1.8	0.6	1.2	0.78	0.8	2.23	1.3	1.8	0.28	1.6	1.5
5	0.5	0.77	0.2	0.6	0.27	0.7	0.84	0.4	0.53	0.09	0	0.56
10	0.2	0.39		0.2	0.087	0.6	0.38		0.2	0.03	0	0.21
15	0.0			0	0.029	0.2				0.01	0	

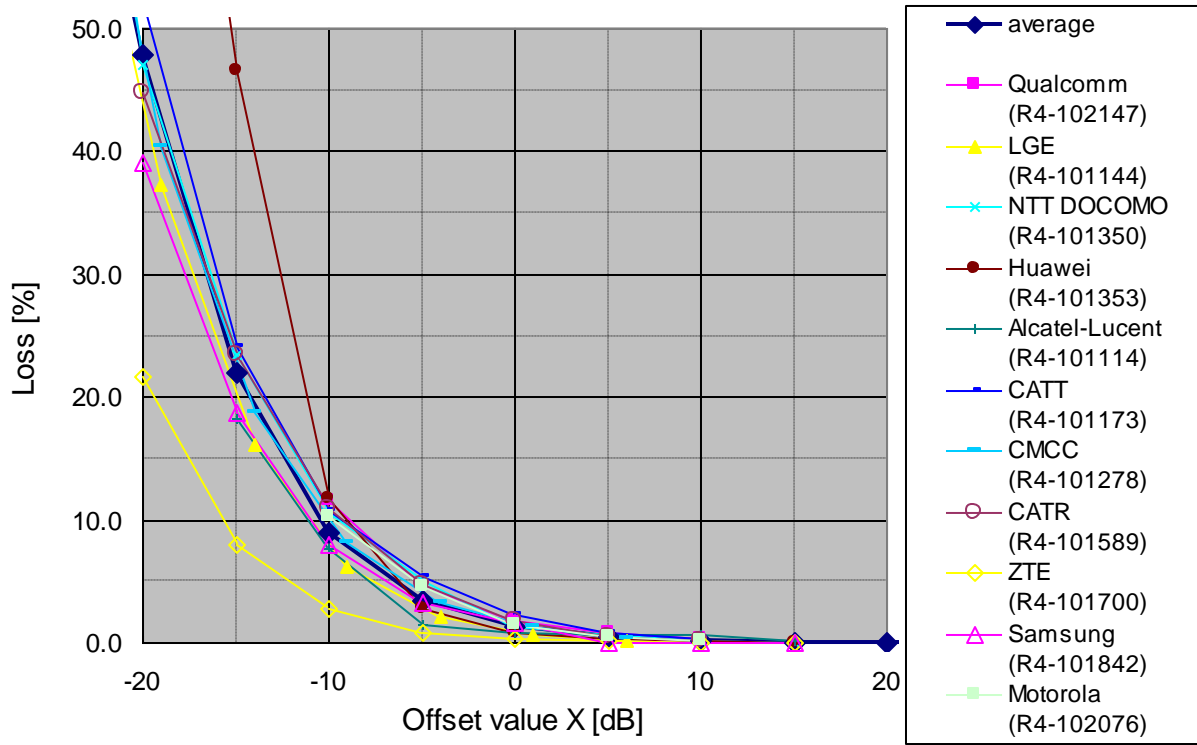

Figure 12.12 5%-ile E-UTRA downlink throughput loss

12.2.1.2 ACIR Uplink 40 MHz Advanced E-UTRA interferer – 10 MHz E-UTRA victim

Simulations are based on the following assumptions:

- Aggressor system: 40 MHz Advanced E-UTRA
- Victim system: 10 MHz E-UTRA
- Simulation frequency: 2000 MHz
- Environment: Macro Cell, Urban Area, uncoordinated deployment
- Cell Range 500 m

Simulation results for average E-UTRA uplink cell throughput loss are presented in table 12.14 and figure 12.13 for TPC set 1 and table 12.15 and figure 12.14 for TPC set 2 respectively. Simulation results for 5% CDF E-UTRA uplink user throughput loss are presented in table 12.16 and figure 12.15 for TPC set 1 and table 12.17 and figure 12.16 for TPC set 2 respectively.

Table 12.14 average E-UTRA uplink throughput loss (TPC set 1)

Offset value X [dB]	average	Qualcomm (R4-101307)	LGE (R4-101144)	NTT DOCOMO (R4-101341)	NOKIA (R4-101389)	Huawei (R4-102054)	Alcatel-Lucent (R4-101114)	CATT (R4-101173)	CMCC (R4-101278)	ZTE (R4-101700)	Samsung (R4-101842)	Motorola (R4-102076)
-20	27.9					35.90				19.84		
-15	22.5		34.7	25.6		21.73	21.8		18.7	11.09	23.6	
-10	12.5	13.16	18.6	13.2	20.41	11.53	10.6	10.29	9	5.46	10.7	14.8
-5	5.7	5.71	8.8	6.1	10.33	5.29	4.7	4.65	3.8	2.27	4.4	6.3
0	2.4	2.60	3.8	2.6	4.7	2.11	2.3	1.98	1.6	0.81	1.7	2.4
5	0.9	1.18	1.5	1.0	1.97	0.75	0.9	0.77	0.5	0.27	0.6	0.95
10	0.4	0.50	0.6	0.4	0.78	0.25	0.4	0.3	0.2	0.09	0.2	0.28
15	0.1		0.2	0.0		0.08	0.1	0.1	0.1	0.03	0.1	
20	0.0							0.04				

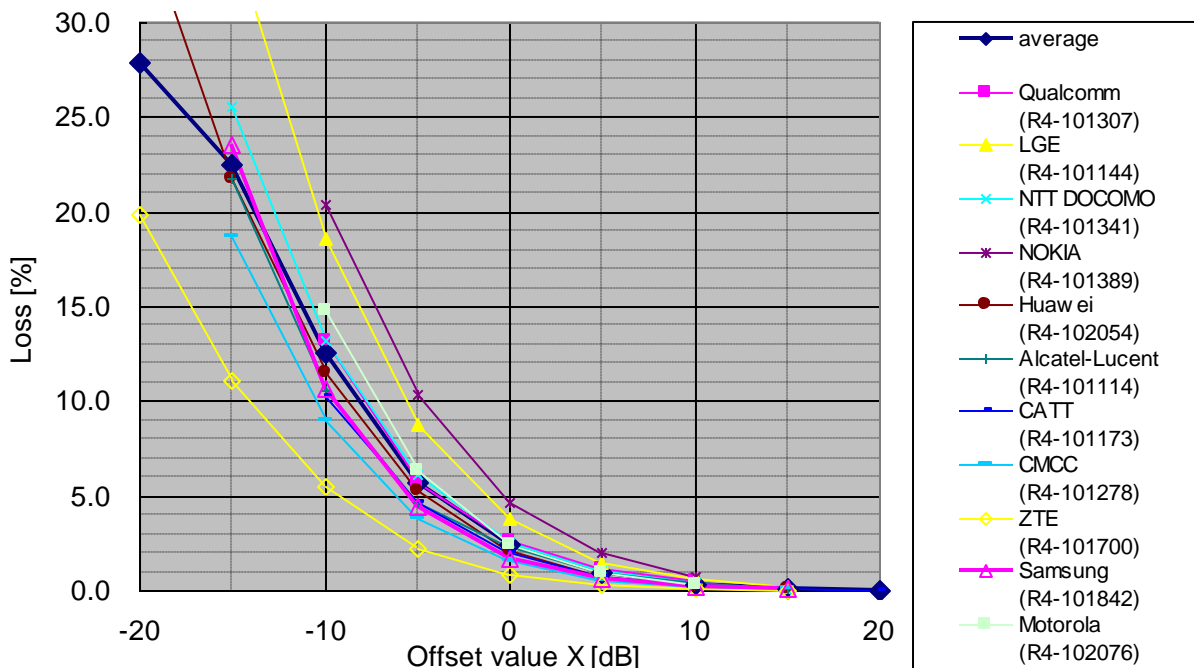

Figure 12.13 average E-UTRA uplink throughput loss (TPC set 1)

Table 12.15 average E-UTRA uplink throughput loss (TPC set 2)

Offset value X [dB]	average	Qualcomm (R4-101307)	LGE (R4-101144)	NTT DOCOMO (R4-101341)	NOKIA (R4-101389)	Huawei (R4-102054)	Alcatel-Lucent (R4-101114)	CATT (R4-101173)	CMCC (R4-101278)	ZTE (R4-101700)	Samsung (R4-101842)	Motorola (R4-102076)
-20	19.0					28.35				9.64		
-15	15.3		22.6	17.5		15.35	15.7		12.4	5.25	18.2	
-10	7.5	7.8	10.9	8.3	10.6	7.16	7.4	6.2	5.4	2.22	8.4	8.49
-5	3.2	3.34	4.7	3.6	4.72	2.90	3.2	2.62	2.2	0.79	3.5	3.34
0	1.2	1.31	1.9	1.4	1.95	1.05	1.3	1.04	0.8	0.26	1.4	1.23
5	0.5	0.61	0.7	0.5	0.76	0.35	0.5	0.39	0.4	0.08	0.5	0.42
10	0.2	0.29	0.3	0.2	0.28	0.11	0.2	0.14	0.2	0.03	0.2	0.13



15	0.1		0.1	0.0		0.04	0.1	0.06	0.1	0.01	0.1	
20	0.0							0.02				

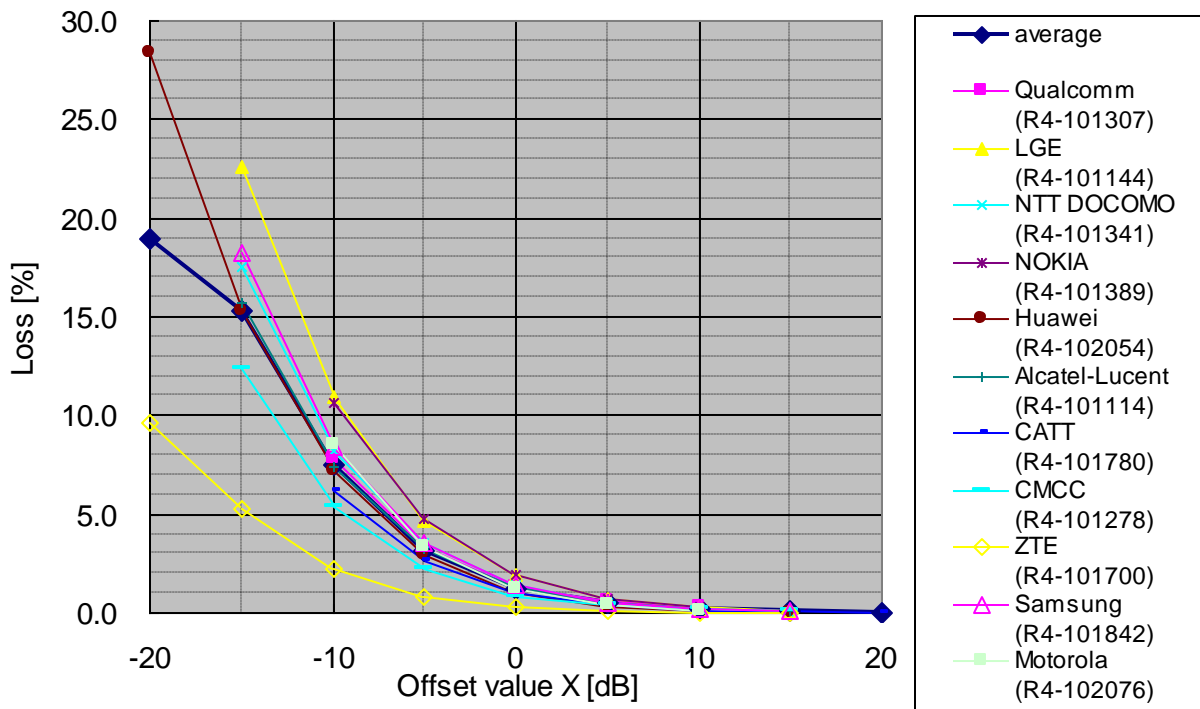

Figure 12.14 average E-UTRA uplink throughput loss (TPC set 2)

Table 12.16 5%-ile E-UTRA uplink throughput loss (TPC set 1)

Offset value X [dB]	average	Qualcomm (R4-101307)	LGE (R4-101144)	NTT DOCOMO (R4-101341)	Huawei (R4-102054)	Alcatel-Lucent (R4-101114)	CATT (R4-101178)	CMCC (R4-101278)	ZTE (R4-101700)	Samsung (R4-101842)	Motorola (R4-102076)
-20	53.2				51.49				54.93		
-15	39.4		90.2	42.4	25.83	36.7		34.2	17.51	29.1	
-10	14.5	17.22	29.8	17.1	8.25	14.6	11.74	12.9	5.55	11.5	16.6
-5	5.6	6.42	11	6.5	2.32	7.9	5.17	4.6	1.76	4.2	5.8
0	1.9	2.24	4	2.9	0.57	2.6	1.99	1.5	0.56	1.8	1.3
5	0.7	1.09	1.5	1.3	0.19	0.6	0.64	0.5	0.18	0.6	0.62
10	0.2	0.56	0.3	0.4	0.06	0.1	0.14	0.2	0.06	0	0.14
15	0.0		0	0.0	0.02	0	0.06	0.2	0.02	0	
20	0.0						0.02				

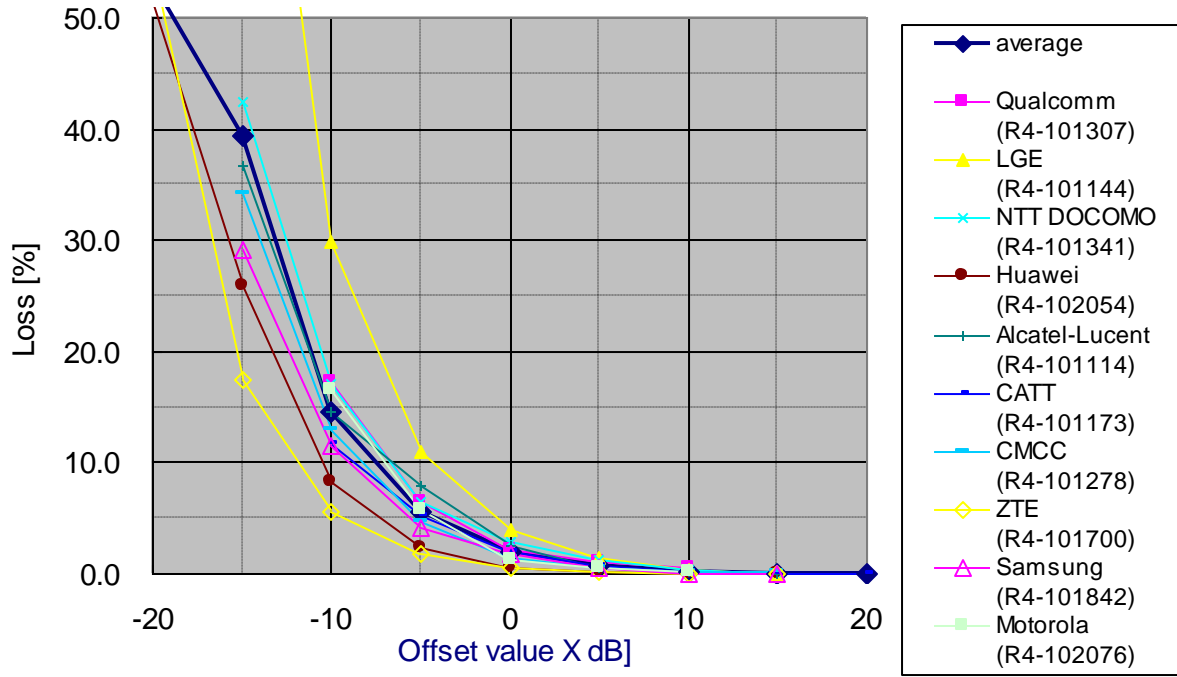

Figure 12.15 5%-ile E-UTRA uplink throughput loss (TPC set 1)

Table 12.17 5%-ile E-UTRA uplink throughput loss (TPC set 2)

Offset value X [dB]	average	Qualcomm (R4-101307)	LGE (R4-101144)	NTT DOCOMO (R4-101341)	Huawei (R4-102054)	Alcatel-Lucent (R4-101114)	CATT (R4-101780)	CMCC (R4-101278)	ZTE (R4-101700)	Samsung (R4-101842)	Motorola (R4-102076)
-20	32.2				41.14				23.27		
-15	26.6		52.8	31.7	17.91	30.8		23.9	7.37	21.6	
-10	11.6	15.7	20.7	13.0	6.41	14.6	10.13	9.5	2.33	8.8	14.39
-5	4.2	5.5	7.6	5.2	1.68	5.4	3.94	3.2	0.74	4	4.75
0	1.3	1.81	2.7	1.8	0.51	1.3	0.97	0.9	0.23	1.6	1.05
5	0.5	0.8	0.8	0.7	0.17	0.3	0.34	0.3	0.07	0.8	0.3
10	0.1	0.13	0.1	0.2	0.05	0	0.06	0.1	0.02	0.1	0.09
15	0.0		0	0	0.02	0	0.01	0.1	0.01	0	
20	0.0						0				

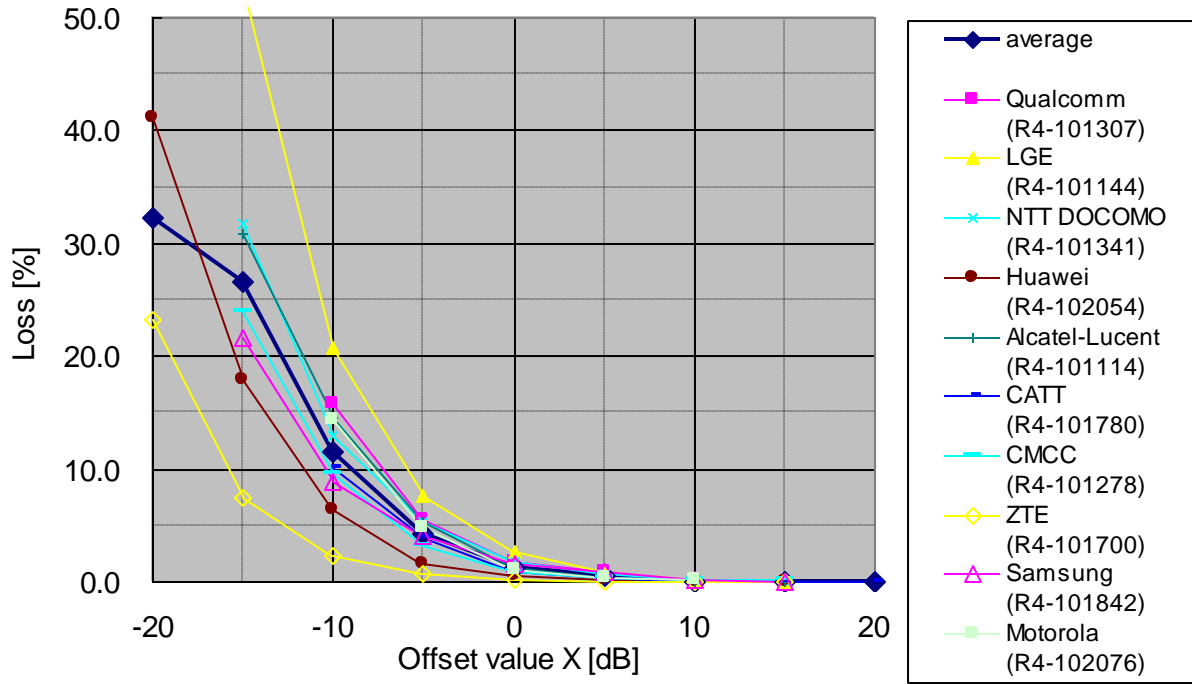

Figure 12.16 5%-ile E-UTRA uplink throughput loss (TPC set 2)

12.2.1.3 ACIR Downlink 40 MHz Advanced E-UTRA interferer – 40 MHz Advanced E-UTRA victim

Simulations are based on the following assumptions:

- Aggressor system: 40 MHz Advanced E-UTRA
- Victim system: 40 MHz Advanced E-UTRA
- Simulation frequency: 2000 MHz
- Environment: Macro Cell, Urban Area, uncoordinated deployment
- Cell Range 500 m

Simulation results for average Advanced E-UTRA downlink cell throughput loss are presented in table 12.18 and figure 12.17. Simulation results for 5% CDF Advanced E-UTRA downlink user throughput loss are presented in table 12.19 and figure 12.18.

Table 12.18 average Advanced E-UTRA downlink throughput loss

ACIR offset X [dB]	average	Qualcomm (R4-101446)	LGE (R4-101145)	NTT DOCOMO (R4-101350)	Huawei (R4-101354)	Alcatel-Lucent (R4-101114)	CMCC (R4-101279)	CATR (R4-101589)	ZTE (R4-101701)	Samsung (R4-101843)	Motorola (R4-102077)
-20	20.8			21.9	14.61				25.81		
-15	12.1		10.5	12.4	7.66	12.8	11.9		17.53	12.2	
-10	6.4	6.4	5.2	6.5	3.62	6.6	6.1	6.18	10.93	6.1	5.92
-5	3.1	3.2	2.3	3.2	1.51	3.2	2.7	3.04	6.43	2.8	2.69
0	1.4	1.47	0.9	1.4	0.55	1.4	1.1	1.37	3.66	1.2	1.03

5	0.7	0.48	0.3	0.6	0.18	1.3	0.4	0.55	2.03	0.5	0.54
10	0.3	0.16	0.1	0.2	0.05	0.2	0.2	0.21	1.10	0.2	0.14
15	0.1		0	0.1	0.006	0.1	0	0.07	0.60	0.1	
20	0.0			0.0							

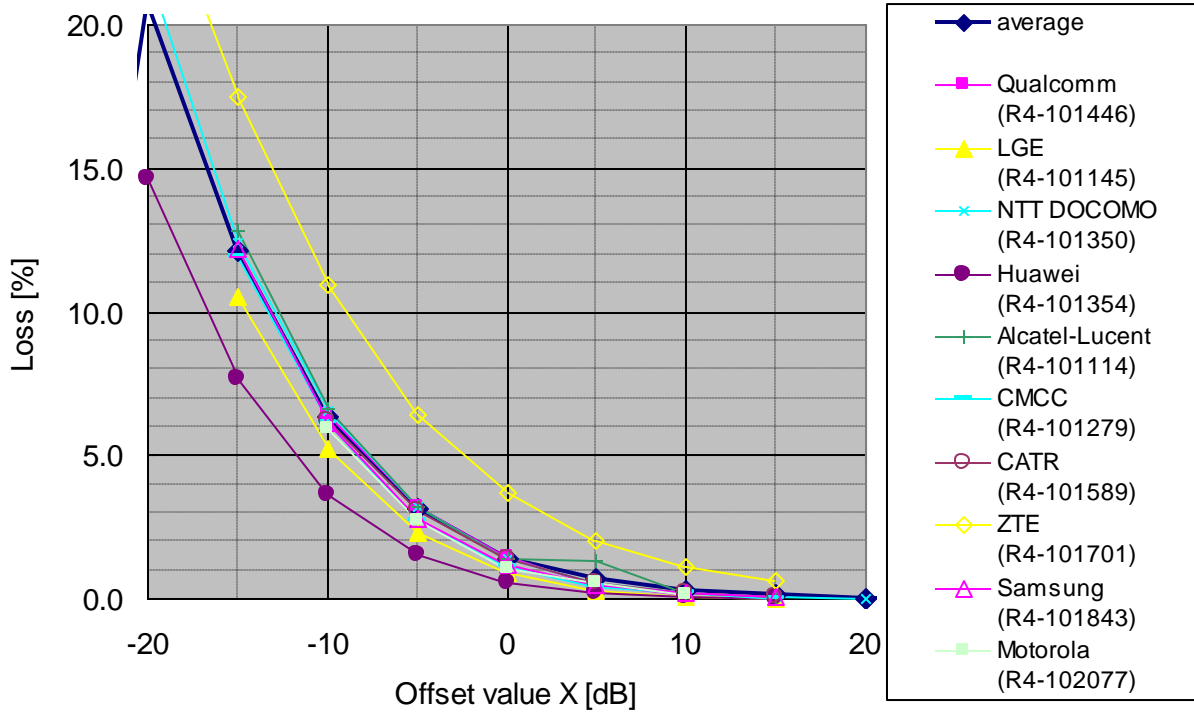

Figure 12.17 average Advanced E-UTRA downlink throughput loss

Table 12.19 5%ile Advanced E-UTRA downlink throughput loss

ACIR offset X [dB]	average	Qualcomm (R4-101446)	LGE (R4-101145)	NTT DOCOMO (R4-101350)	Huawei (R4-101354)	Alcatel-Lucent (R4-101114)	CMCC (R4-101279)	CATR (R4-101589)	ZTE (R4-101701)	Samsung (R4-101843)	Motorola (R4-102077)
-25	100.0			100.0	100.0						
-20	93.7			100.0	100				81.15		
-15	55.6		49.2	54.4	83.17	48.7	52.6		57.67	43.4	
-10	25.8	27.9	23	28.8	26.3	21.2	25.7	26.82	30.11	21.9	26.71
-5	11.1	12.9	9.2	14.1	8.71	8.9	11.4	12.86	12.00	9.4	11.32
0	4.3	5.8	3.2	6.0	2.4	2.3	4.3	5.43	4.13	4.7	4.28
5	1.6	2.2	0.9	2.40	1.11	1.7	1.4	1.91	1.35	1.6	1.76
10	0.5	0.68	0.4	0.75	0.32	0.8	0.4	0.74	0.43	0	0.72
15	0.2		0.1	0.15	0.19	0.6	0.1	0.23	0.14	0	
20	0.2			0.15							

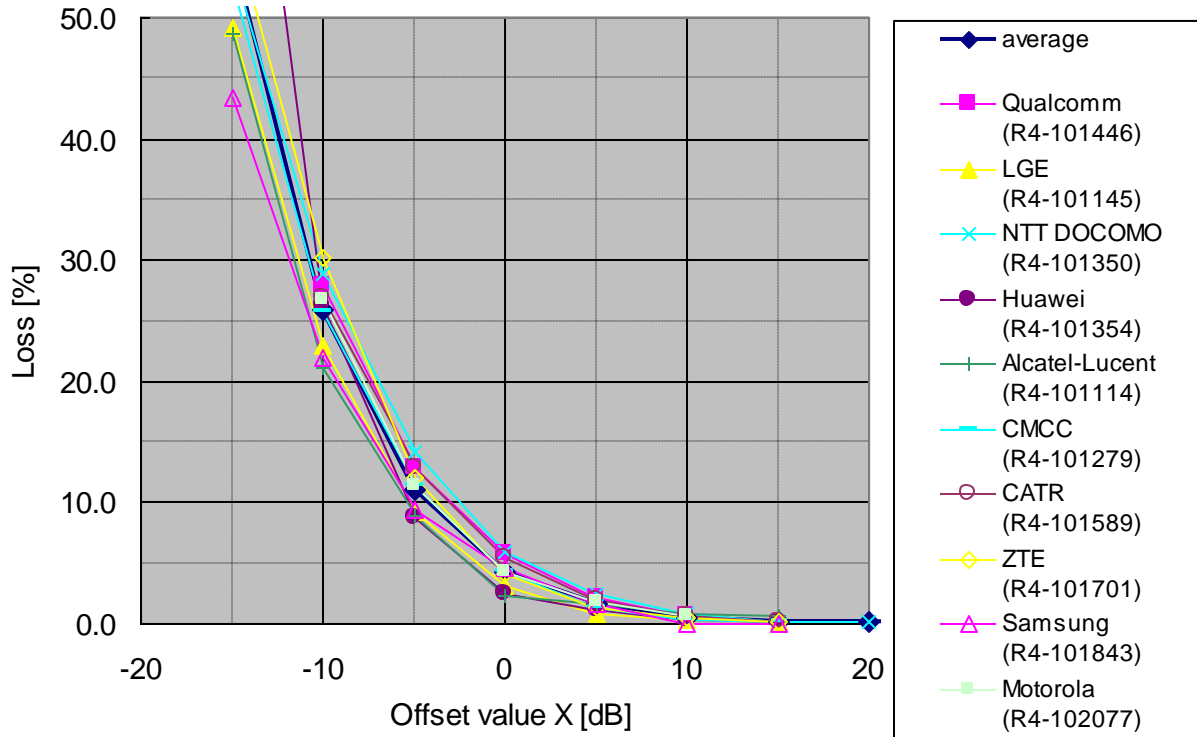

Figure 12.18 5%-ile Advanced E-UTRA downlink throughput loss

12.2.1.4 ACIR Uplink 40 MHz Advanced E-UTRA interferer – 40 MHz Advanced E-UTRA victim

Simulations are based on the following assumptions:

- Aggressor system: 40 MHz Advanced E-UTRA
- Victim system: 40 MHz Advanced E-UTRA
- Simulation frequency: 2000 MHz
- Environment: Macro Cell, Urban Area, uncoordinated deployment
- Cell Range 500 m

Simulation results for average Advanced E-UTRA uplink cell throughput loss are presented in table 12.20 and figure 12.19 for TPC set 1 and table 12.21 and figure 12.20 for TPC set 2 respectively. Simulation results for 5% CDF Advanced E-UTRA uplink user throughput loss are presented in table 12.22 and figure 12.21 for TPC set 1 and table 12.23 and figure 12.22 for TPC set 2 respectively.

Table 12.20 average Advanced E-UTRA uplink throughput loss (TPC set 1)

Offset value X [dB]	average	Qualcomm (R4-101307)	LGE (R4-101145)	NTT DOCOMO (R4-101341)	NOKIA (R4-101389)	Huawei (R4-102054)	Alcatel-Lucent (R4-101114)	CATT (R4-101173)	CMCC (R4-101965)	ZTE (R4-101701)	Samsung (R4-101843)	Motorola (R4-102077)
-20	25.7					34.53			27.4	15.2573		
-15	18.0		31.2	19.1		20.60	17.7		13.5	6.8806	16.9	

-10	9.7	8.78	16	9.1	16.48	10.72	8.1	10.29	5.8	2.9315	6.9	11.12
-5	4.2	3.64	7.2	3.8	7.72	4.78	3.3	4.65	2.3	1.1669	2.5	5.13
0	1.7	1.37	2.9	1.5	3.2	1.85	1.2	1.98	0.8	0.427	0.9	2.32
5	0.6	0.52	1.1	0.6	1.23	0.64	0.4	0.77	0.3	0.1448	0.3	0.94
10	0.2	0.19	0.4	0.2	0.45	0.21	0.1	0.3	0.1	0.047	0.1	0.35
15	0.0		0.1	0.0		0.07	0	0.1		0.015	0	
20	0.0							0.04				

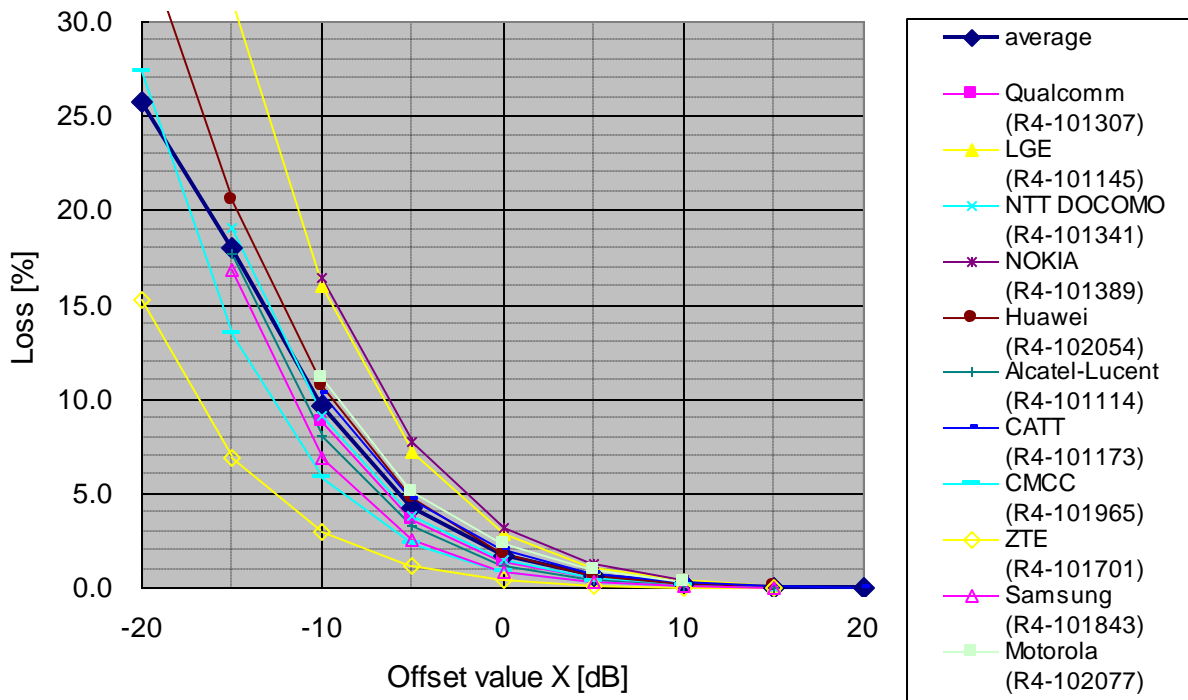

Figure 12.19 average Advanced E-UTRA uplink throughput loss (TPC set 1)

Table 12.21 average Advanced E-UTRA uplink throughput loss (TPC set 2)

Offset value X [dB]	average	Qual comm (R4-101307)	LGE (R4-101145)	NTT DOCOMO (R4-101341)	NOKIA (R4-101389)	Hua wei (R4-102054)	Alcatel-Lucent (R4-101114)	CMCC (R4-101965)	ZTE (R4-101701)	Sam sung (R4-101843)	Moto rola (R4-102077)
-20	19.3					26.97		18.5	12.51		
-15	11.8		18.4	12.3		14.34	11.3	8.2	5.22	12.6	
-10	5.8	7.8	8.2	5.3	7.43	6.54	4.6	3.2	1.99	5.2	7.91
-5	2.3	3.34	3.3	2.1	2.95	2.58	1.7	1.1	0.69	1.9	3.63
0	0.9	1.31	1.2	0.8	1.1	0.91	0.6	0.4	0.23	0.7	1.42
5	0.3	0.61	0.4	0.3	0.4	0.30	0.2	0.2	0.07	0.2	0.51
10	0.1	0.29	0.1	0.1	0.14	0.10	0.1	0	0.02	0.1	0.26
15	0.0		0	0		0.03	0	0	0.01	0	

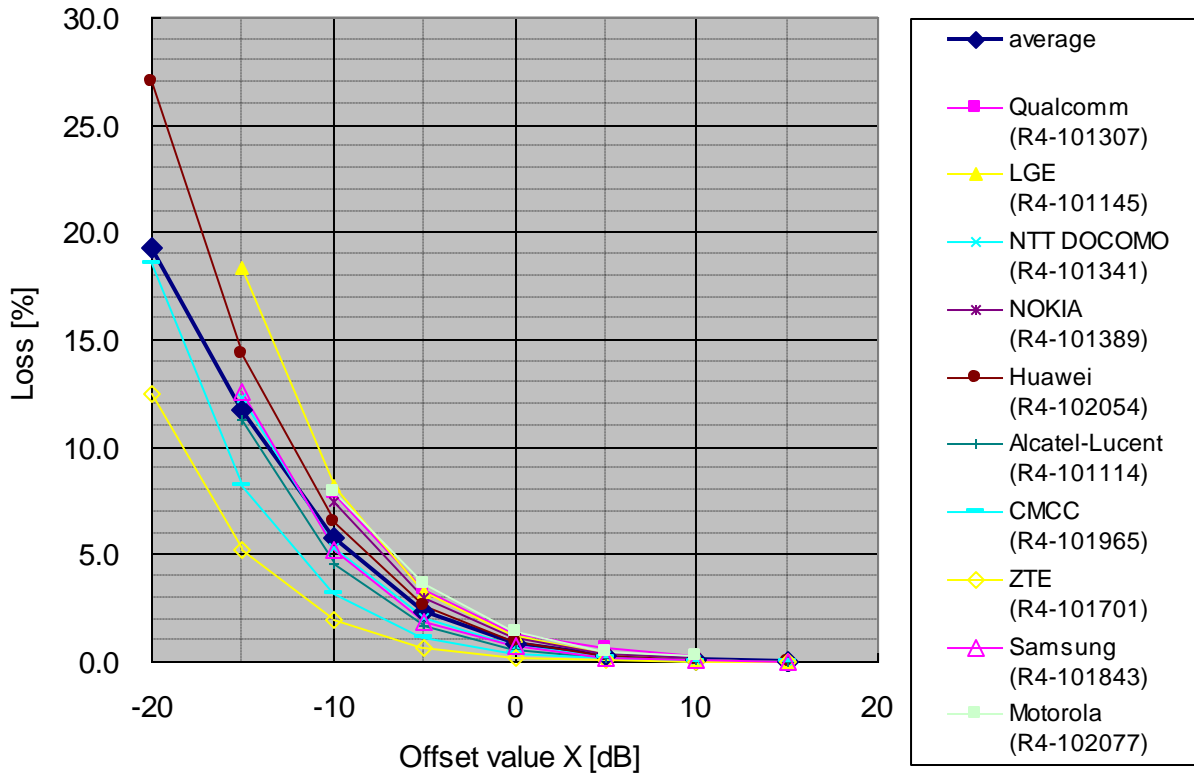

Figure 12.20 average Advanced E-UTRA uplink throughput loss (TPC set 2)

Table 12.22 5%-ile Advanced E-UTRA uplink throughput loss (TPC set 1)

Offset value X [dB]	average	Qual comm (R4-101307)	LGE (R4-101145)	NTT DOCOMO (R4-101341)	Hua wei (R4-102054)	Alcatel-Lucent (R4-101114)	CMCC (R4-101965)	CATT (R4-101173)	ZTE (R4-101701)	Sam sung (R4-101843)	Moto rola (R4-102077)
-20	49.4				45.39		43		59.7369		
-15	25.2		54.1	26.4	21.29	22.5	16		19.6959	16.4	
-10	8.8	7.42	20.8	8.2	6.42	6.3	5	11.74	6.3135	5.5	10.38
-5	3.0	2.4	6.5	2.4	1.75	1.9	1.7	5.17	2.0052	1.8	4.36
0	1.0	0.81	1.9	1.0	0.46	0.6	0.5	1.99	0.635	0.1	1.73
5	0.3	0.29	0.6	0.3	0.14	0.1	0.2	0.64	0.2009	0	0.42
10	0.1	0.12	0.2	0.0	0.05	0	0	0.14	0.0635	0	0.18
15	0.0		0.1	0	0.01	0	0	0.06	0.0201	0	
20	0.0							0.02			

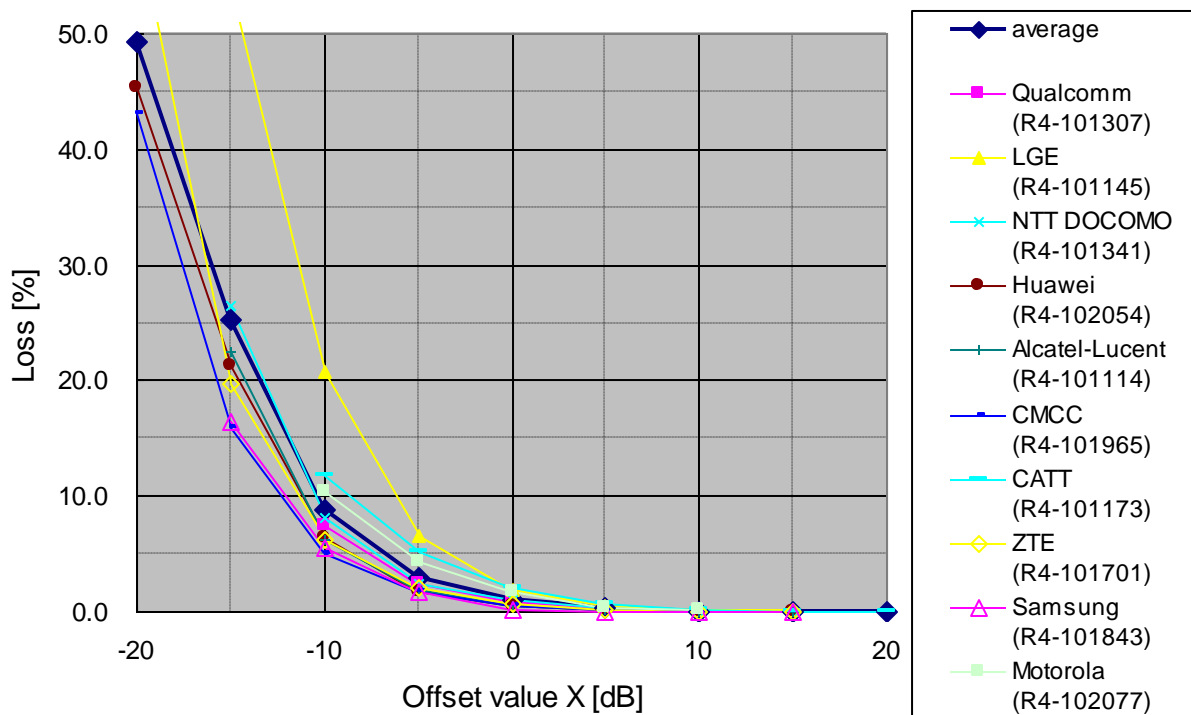

Figure 12.21 5%-ile Advanced E-UTRA uplink throughput loss (TPC set 1)

Table 12.23 5%-ile Advanced E-UTRA uplink throughput loss (TPC set 2)

Offset value X [dB]	average	Qual comm (R4-101307)	LGE (R4-101145)	NTT DOCOMO (R4-101341)	Hua wei (R4-102054)	Alcatel-Lucent (R4-101114)	CMCC (R4-101965)	ZTE (R4-101701)	Sam sung (R4-101843)	Moto rola (R4-102077)
-20	30.7				38.89		28.5	24.8201		
-15	16.3		33.3	19.3	16.04	13.5	11.2	9.4545	11.2	
-10	6.2	6.69	12.5	8.0	5.79	4.4	4	3.1966	4	7.28
-5	2.2	1.93	4.2	2.8	1.40	1.6	1.3	1.0335	1.6	3.63
0	0.8	0.803	1.4	1.3	0.38	0.6	0.4	0.3291	0.8	1.21
5	0.2	0.183	0.4	0.2	0.12	0.2	0.1	0.1043	0	0.23
10	0.0	0.01	0.1	0.0	0.04	0.1	0	0.033	0	0.1
15	0.0		0	0	0.01	0	0	0.0104	0	



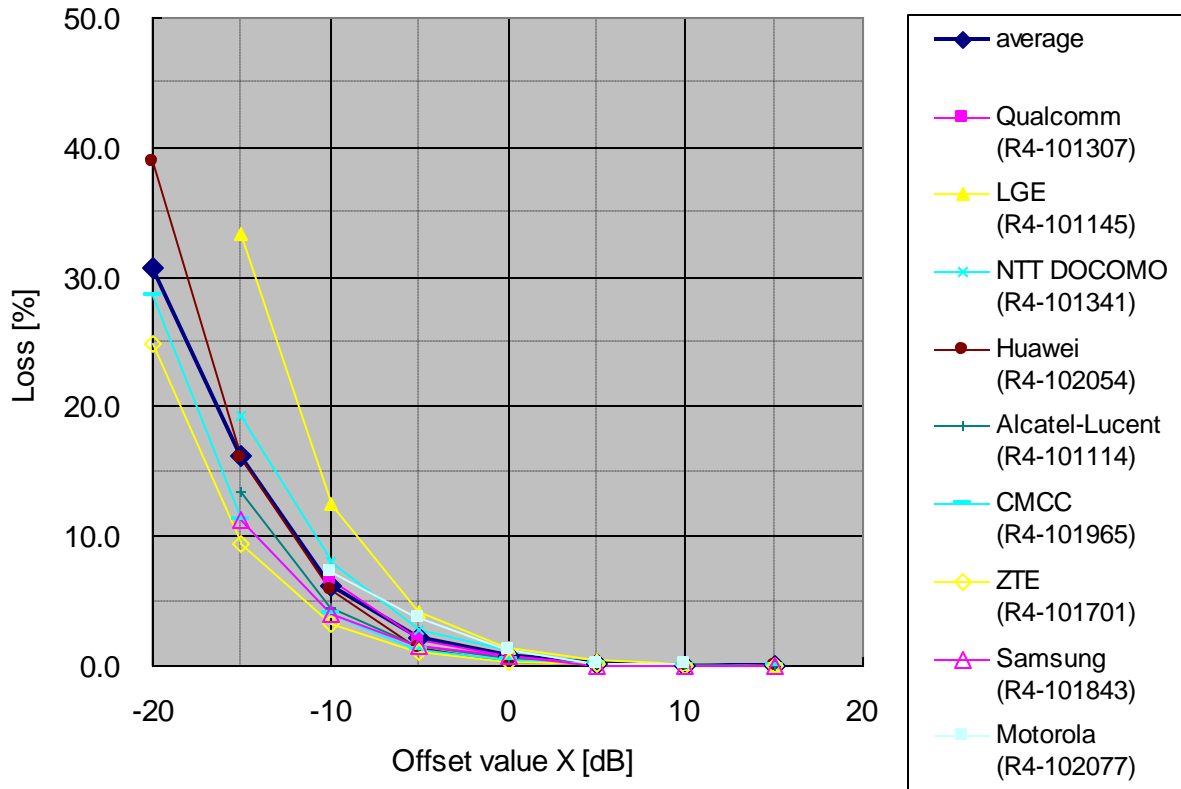

Figure 12.22 5%-ile Advanced E-UTRA uplink throughput loss (TPC set 2)

12.2.1.5 ACIR Downlink 40 MHz Advanced E-UTRA interferer – 5 MHz UTRA victim

Simulations are based on the following assumptions:

- Aggressor system: 40 MHz Advanced E-UTRA
- Victim system: 5 MHz UTRA
- Simulation frequency: 2000 MHz
- Environment: Macro Cell, Urban Area, uncoordinated deployment
- Cell Range 500 m

Simulation results for 5 MHz UTRA downlink capacity loss are presented in table 12.24 and figure 12.23.

Table 12.24 average 5 MHz UTRA downlink capacity loss

Offset value X [dB]	average	NTT DOCOMO (R4-101350)	Huawei (R4-101355)	Alcatel-Lucent (R4-101114)	Qualcomm (R4-102147)	ZTE (R4-102188)
-20	24.1	35.7	11.59			25
-15	16.0	19.1	6.31	22.3		16.3265
-10	8.9	10.2	3.03	11.1	9.83	10.2041
-5	4.7	5.1	1.23	4.5	4.29	8.1633
0	2.0	1.9	0.38	2.1	1.72	4.0816
5	0.9	0.6	0.09	0.7	0.57	2.3168

10	0.5	0.6	0.006	0	0.19	1.5
15	0.0	0	0.004	0		0.063

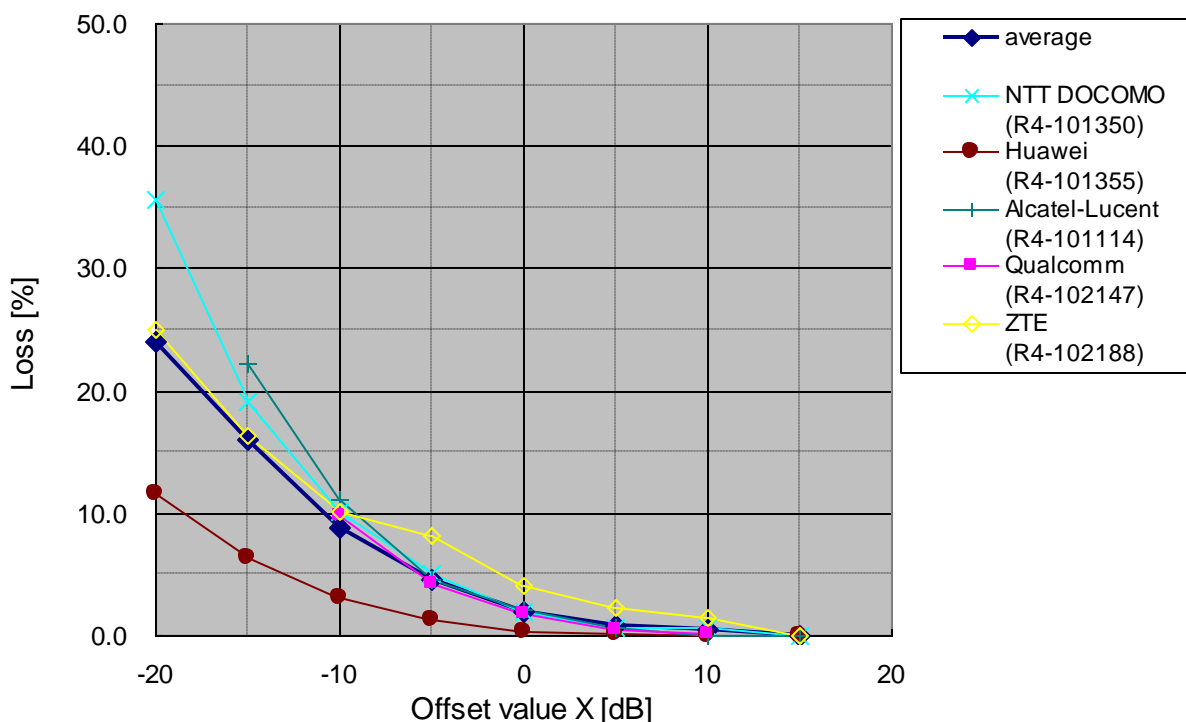

Figure 12.23 average 5 MHz UTRA downlink capacity loss

12.2.1.6 ACIR Uplink 40 MHz Advanced E-UTRA interferer – 5 MHz UTRA victim

Simulations are based on the following assumptions:

- Aggressor system: 40 MHz Advanced E-UTRA
- Victim system: 5 MHz UTRA
- Simulation frequency: 2000 MHz
- Environment: Macro Cell, Urban Area, uncoordinated deployment
- Cell Range 500 m

Simulation results for 5 MHz UTRA uplink capacity loss are presented in table 12.25 and figure 12.24 for Advanced E-UTRA TPC set 1 and in table 12.26 and figure 12.25 for Advanced E-UTRA TPC set 2.

Table 12.25 average 5 MHz UTRA uplink capacity loss (TPC set 1)

Offset value X [dB]	average	Qualcomm (R4-101307)	NTT DOCOMO (R4-101341)	NOKIA (R4-101389)	Huawei (R4-102054)	Alcatel-Lucent (R4-101114)	ZTE (R4-102188)
-20	100.0				100		
-15	100.0		100.0		100	100	
-10	93.1	100	100.0	100	83.42	100	75

-5	86.3	100	100.0	100	69.59	100	48.0969
0	53.5	69.6	70.0	50	41.69	72.1	17.7778
5	16.5	19.7	21.4	15.15	10.79	25.2	6.6667
10	5.6	6.2	6.4	6.06	4.78	6.5	3.3333
15	2.2	2.2	2.857142857	1.52	2.11	2.4	2.3684

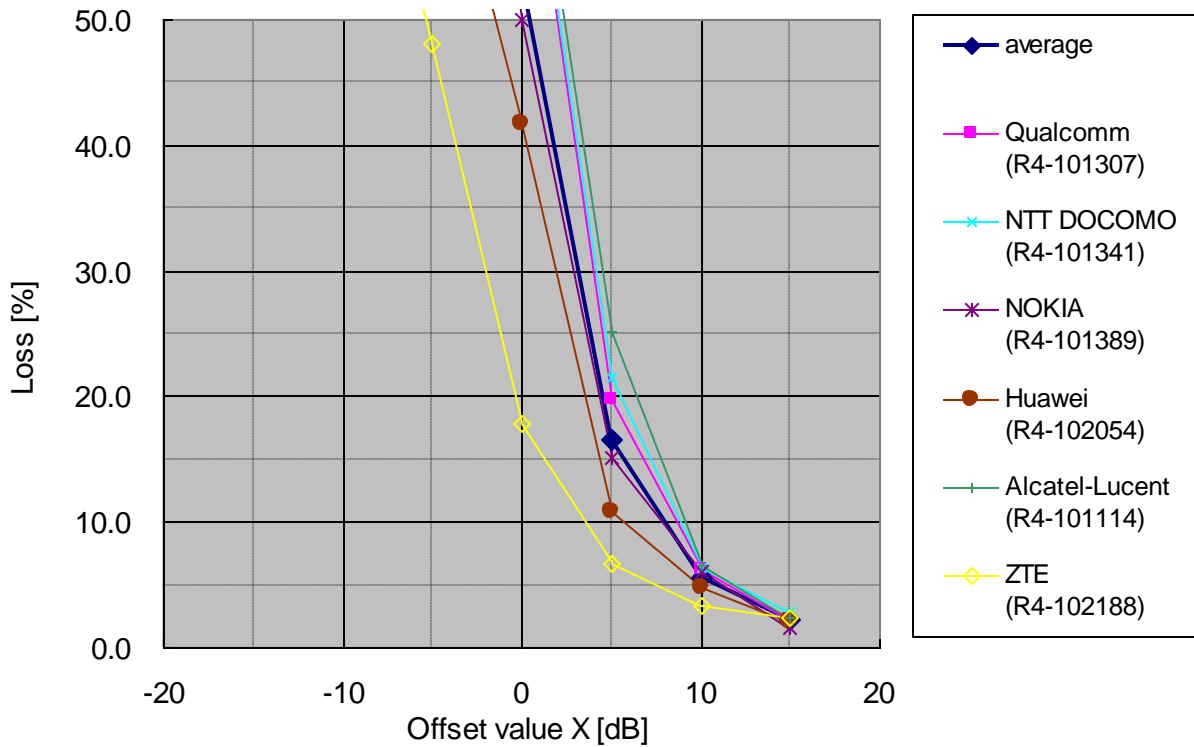

Figure 12.24 average 5 MHz UTRA uplink capacity loss (TPC set 1)

Table 12.26 average 5 MHz UTRA uplink capacity loss (TPC set 2)

Offset value X [dB]	average	Qualcomm (R4-101307)	NTT DOCOMO (R4-101341)	NOKIA (R4-101389)	Huawei (R4-102054)	Alcatel-Lucent (R4-101114)	ZTE (R4-102188)
-20	100.0				100		
-15	83.6		100.0		50.87	100	
-10	37.4	46.04	46.4	33.33	11.89	44.9	41.746
-5	15.4	14.05	14.3	10.61	10.19	16.6	26.6667
0	5.0	4.58	5.0	4.55	2.11	5.2	8.3333
5	2.1	1.66	2.1	1.52	2.11	1.7	3.3333
10	1.1	0.68	1.4	1.52	0.87	0.5	1.6384
15	1.0		0.714285714	1.52	0.87	0.2	1.6384

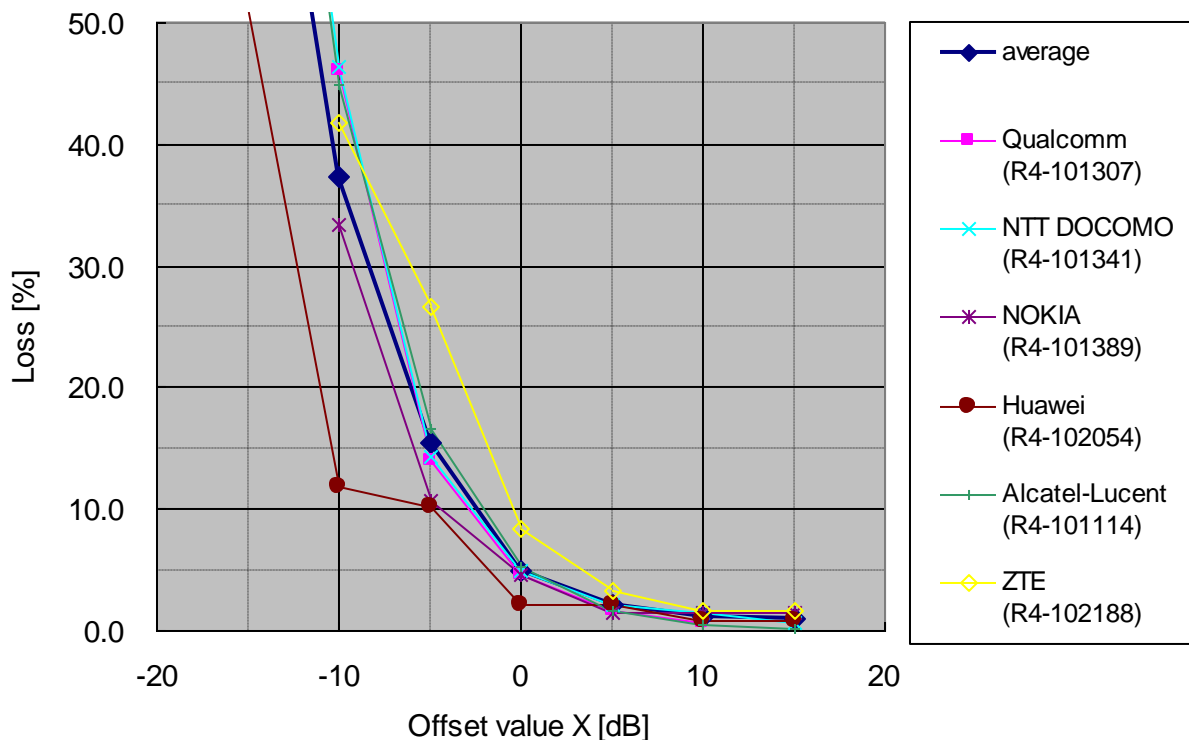

Figure 12.25 average 5 MHz UTRA uplink capacity loss (TPC set 2)

12.2.1.5 ACIR Downlink 40 MHz Advanced E-UTRA interferer – 1.6 MHz UTRA victim

Simulations are based on the following assumptions:

- Aggressor system: 40 MHz Advanced E-UTRA
- Victim system: 1.6 MHz UTRA
- Simulation frequency: 2000 MHz
- Environment: Macro Cell, Urban Area, uncoordinated deployment
- Cell Range 500 m

Simulation results for 1.6 MHz UTRA downlink capacity loss are presented in table 12.27 and figure 12.26.

Table 12.27 average 1.6 MHz UTRA downlink capacity loss

Offset value X [dB]	CMCC (R4-102996)	CATT (R4-102476)	Huawei (R4-103090)	ZTE (R4-103305)	Td-tech (R4-103078)
-20			100.0	99.40	100
-15	97.2	91.33	86.1	99.12	90.41
-10	78.9	26.34	28.5	74.56	29.56
-5	15.2	11.18	10.4	14.56	12.29
0	5.5	5.03	4.18	5.22	4.21
5	2	2.51	3.94	3.54	2.32
10	0.5	1.04	1.89	0.54	0.7
15	0	0		0.06	0

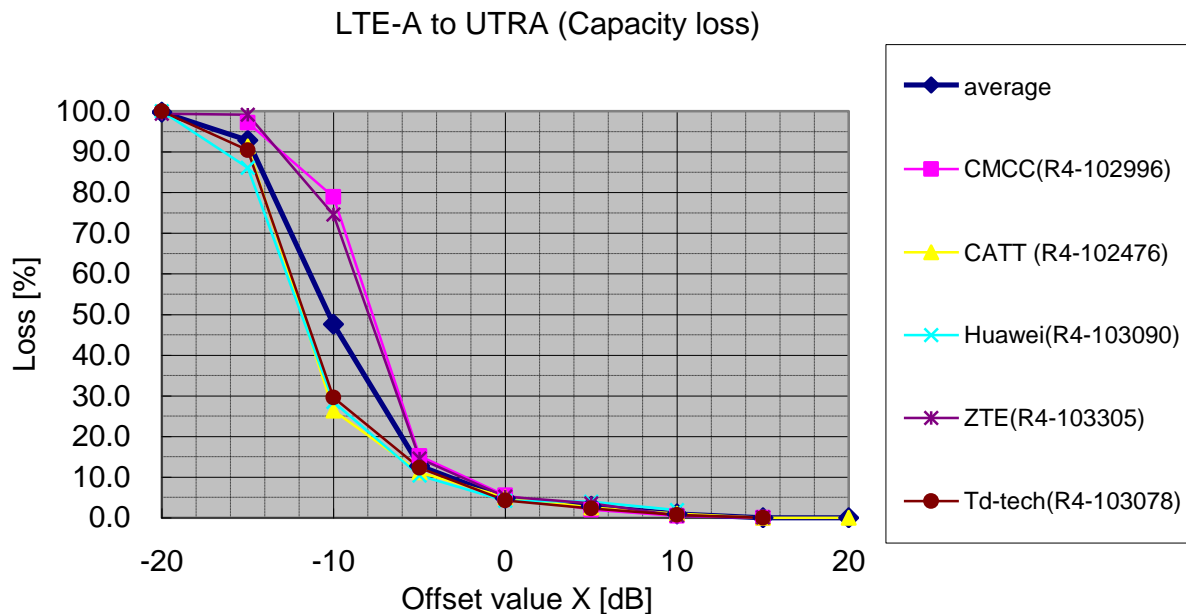

Figure 12.26 average 1.6 MHz UTRA downlink capacity loss

12.2.1.6 ACIR Uplink 40 MHz Advanced E-UTRA interferer – 1.6 MHz UTRA victim

Simulations are based on the following assumptions:

- Aggressor system: 40 MHz Advanced E-UTRA
- Victim system: 1.6 MHz UTRA
- Simulation frequency: 2000 MHz
- Environment: Macro Cell, Urban Area, uncoordinated deployment
- Cell Range 500 m

Simulation results for 5 MHz UTRA uplink capacity loss are presented in table 12.28 and figure 12.27 for Advanced E-UTRA TPC set 1 and in table 12.29 and figure 12.28 for Advanced E-UTRA TPC set 2.

Table 12.28 average 1.6 MHz UTRA uplink capacity loss (TPC set 1)

Offset value X [dB]	CMCC (R4-102996)	CATT (R4-102913)	Huawei (R4-103090)	ZTE (R4-103305)
-20	0	0	0	0
-15	0	0	0	0
-10	0	0	0	0
-5	0	0	0	0
0	0	0	0	0
5	0	0	0	0
10	0	0	0	0

LTE-A to LTE-A (Cell throughput, PC set 1)

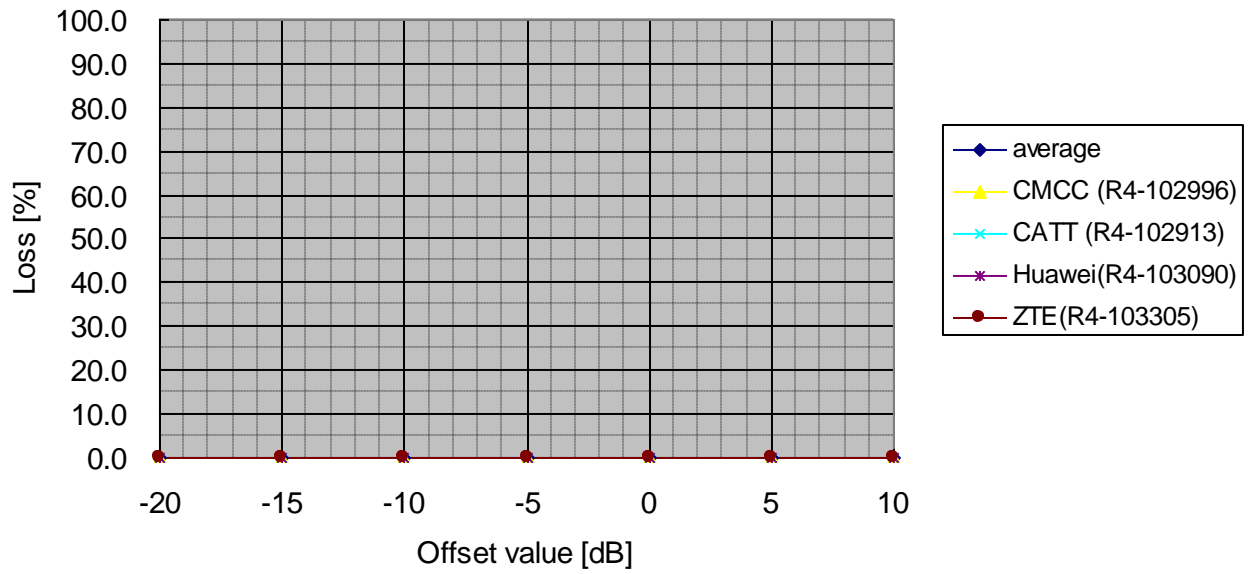

Figure 12.27 average 1.6 MHz UTRA uplink capacity loss (TPC set 1)

Table 12.29 average 1.6 MHz UTRA uplink capacity loss (TPC set 2)

Offset value X [dB]	CMCC (R4-102996)	CATT (R4-102913)	Huawei (R4-103090)	ZTE (R4-103305)
-20	0	0	0	0
-15	0	0	0	0
-10	0	0	0	0
-5	0	0	0	0
0	0	0	0	0
5	0	0	0	0
10	0	0	0	0

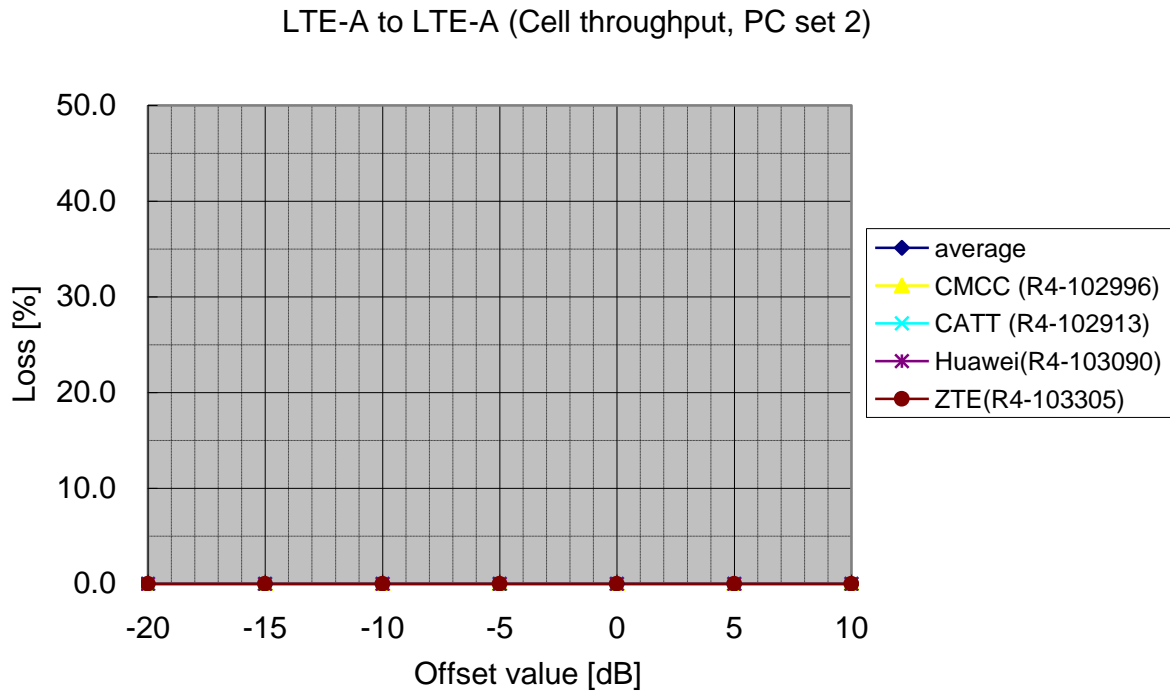

Figure 12.28 average 1.6 MHz UTRA uplink capacity loss (TPC set 2)

## Annex A (informative): Link Level Performance Model

### A.1 Description

Annex A.2 provides detail on how the baseline throughput curves are derived. It shows that the throughput of a modem with link adaptation can be approximated by an attenuated and truncated form of the Shannon bound. (The Shannon bound represents the maximum theoretical throughput than can be achieved over an AWGN channel for a given SNR). The following equations approximate the throughput over a channel with a given SNR, when using link adaptation:

$$\text{Throughput, } Thr, \text{ bps / Hz} = \begin{cases} Thr = 0 & \text{for SNIR} < SNIR_{\text{MIN}} \\ Thr = \alpha \cdot S(\text{SNIR}) & \text{for } SNIR_{\text{min}} < SNIR < SNIR_{\text{MAX}} \\ Thr = Thr_{\text{MAX}} & \text{for } SNIR > SNIR_{\text{MAX}} \end{cases}$$

Where:  $S(\text{SNIR})$  is the Shannon bound:  $S(\text{SNIR}) = \log_2(1+\text{SNIR})$  bps/Hz

$\alpha$	Attenuation factor, representing implementation losses
$SNR_{\text{MIN}}$	Minimum SNIR of the codeset, dB
$Thr_{\text{MAX}}$	Maximum throughput of the codeset, bps/Hz
$SNIR_{\text{MAX}}$	SNIR at which max throughput is reached $S^{-1}(Thr_{\text{MAX}})$ , dB

The parameters  $\alpha$ ,  $SNR_{\text{MIN}}$  and  $THR_{\text{MAX}}$  can be chosen to represent different modem implementations and link conditions. The parameters proposed in table 1 represent a baseline case, which assumes:

- 1:2 antenna configurations
- Typical Urban fast fading channel model (10kmph DL, 3kmph UL)
- Link Adaptation (see table 1 for details of highest and lowest rate codes)
- Channel prediction
- HARQ

**Table A.1 Parameters describing baseline Link Level performance for E-UTRA Co-existence simulations**

Parameter	DL	UL	Notes
$\alpha$ , attenuation	0.6	0.4	Represents implementation losses
$SNR_{\text{MIN}}$ , dB	-10	-10	Based on QPSK, 1/8 rate (DL) & 1/5 rate (UL)
$Thru_{\text{MAX}}$ , bps/Hz	4.4	2.0	Based on 64QAM 4/5 (DL) & 16QAM 3/4 (UL)

Table A.1 shows parameters proposed for the baseline E-UTRA DL and UL. Table A.2 shows the resulting look up table, which is plotted in Figure A.1. Table A.2 gives throughput in terms of spectral efficiency (bps per Hz), and per 375kHz Resource Block (RB), in kbps.



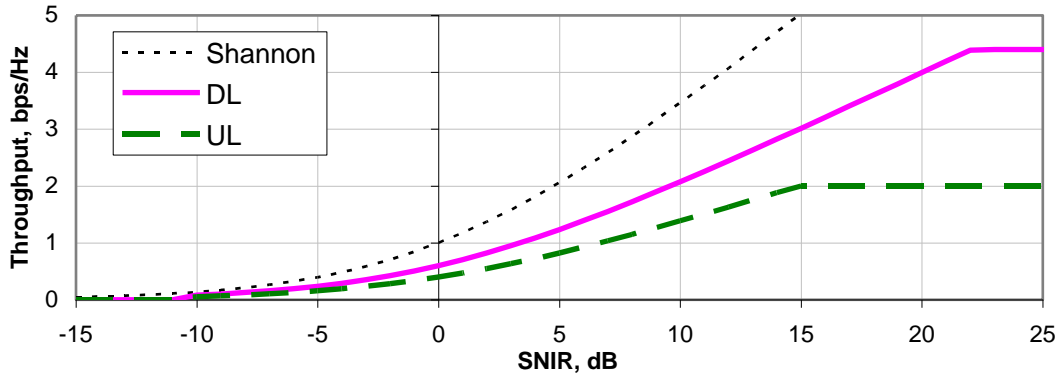
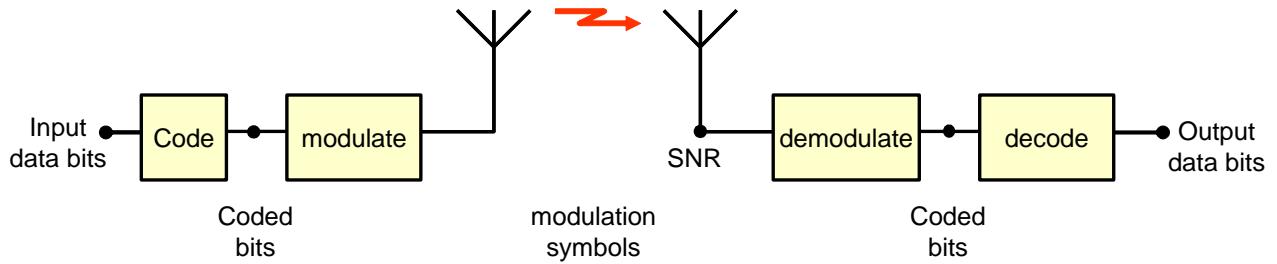

Figure A.1 Throughput vs SNIR for Baseline E-UTRA Coexistence Studies

Table A.2 Look-Up-Table of UL and DL Throughput vs. SNIR for Baseline E-UTRA Coexistence Studies

SNIR dB	Throughput			
	bps/Hz		kbps per 375kHz RB	
	DL	UL	DL	UL
-15	0	0	0	0
-14	0	0	0	0
-13	0	0	0	0
-12	0	0	0	0
-11	0	0	0	0
-10	0.08	0.06	31	21
-9	0.10	0.07	38	26
-8	0.13	0.08	48	32
-7	0.16	0.10	59	39
-6	0.19	0.13	73	48
-5	0.24	0.16	89	59
-4	0.29	0.19	109	73
-3	0.35	0.23	132	88
-2	0.42	0.28	159	106
-1	0.51	0.34	190	127
0	0.60	0.40	225	150
1	0.71	0.47	265	176
2	0.82	0.55	308	206
3	0.95	0.63	356	237
4	1.09	0.72	408	272
5	1.23	0.82	463	309
6	1.39	0.93	521	347
7	1.55	1.04	582	388
8	1.72	1.15	646	430
9	1.90	1.26	711	474
10	2.08	1.38	778	519
11	2.26	1.51	847	565
12	2.44	1.63	917	611
13	2.63	1.76	988	658
14	2.82	1.88	1059	706
15	3.02	2.00	1131	750
16	3.21	2.00	1204	750
17	3.41	2.00	1277	750
18	3.60	2.00	1350	750
19	3.80	2.00	1424	750
20	3.99	2.00	1498	750
21	4.19	2.00	1572	750
22	4.39	2.00	1646	750
23	4.40	2.00	1650	750
24	4.40	2.00	1650	750
25	4.40	2.00	1650	750

## A.2 Modelling of Link Adaptation

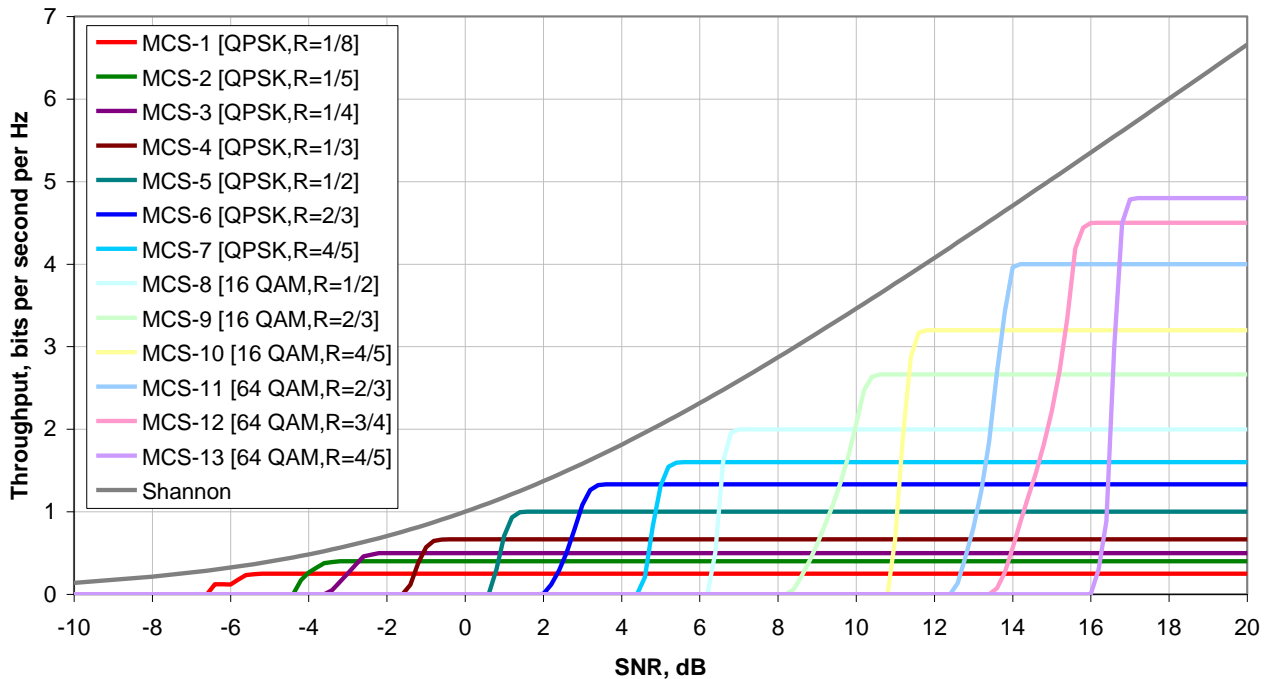

**Figure A.3 Coding and Modulation for Transmission of data over a radio link**

Figure A.3 shows a radio transmitter and receiver. The throughput over a radio link is the number of data bits that can be successfully transmitted per modulation symbol. Coding (more specifically, Forward Error Correction) adds redundant bits to the data bits which can correct errors in the received bits. The degree of coding is determined by its *rate*, the proportion of data bits to coded bits. This typically varies from  $1/8^{\text{th}}$  to  $4/5^{\text{th}}$ . Coded bits are then converted into modulation symbols. The order of the modulation determines the number coded bits that can be transmitted per modulation symbol. Typical examples are QPSK and 16 QAM, which have 2 and 4 bits per modulation symbol, respectively.

The maximum throughput of a given MCS (Modulation and Coding Scheme) is the product of the rate and the number of bits per modulation symbol. Throughput has units of data bits per modulation symbol. This is commonly normalised to a channel of unity bandwidth, which carries one symbol per second. The units of throughput then become bits per second, per Hz.

A given MCS requires a certain SNIR (measured at the rx antenna) to operate with an acceptably low BER (Bit Error Rate) in the output data. An MCS with a higher throughput needs a higher SNIR to operate. AMC (Adaptive Modulation and Coding) works by measuring and feeding back the channel SNIR to the transmitter, which then chooses a suitable MCS from a ‘codeset’ to maximise throughput at that SNIR. A codeset contains many MCS’s and is designed to cover a range of SNRs. An example of a codeset is shown in Figure A.4. Each MCS in the codeset has the highest throughput for a 1-2dB range of SNIR.



**Figure A.4 Throughput of a set of Coding and Modulation Combinations, AWGN channels assumed**

Figure A.4 also shows the Shannon bound, which represents the maximum theoretical throughput that can be achieved over an AWGN channel with a given SNR. The example AMC system achieves around 0.75x the throughput of the

Shannon bound, over the range of SNR which it operates. We can approximate the performance of AMC with an attenuated and truncated form of the Shannon bound as shown in Figure A.5.

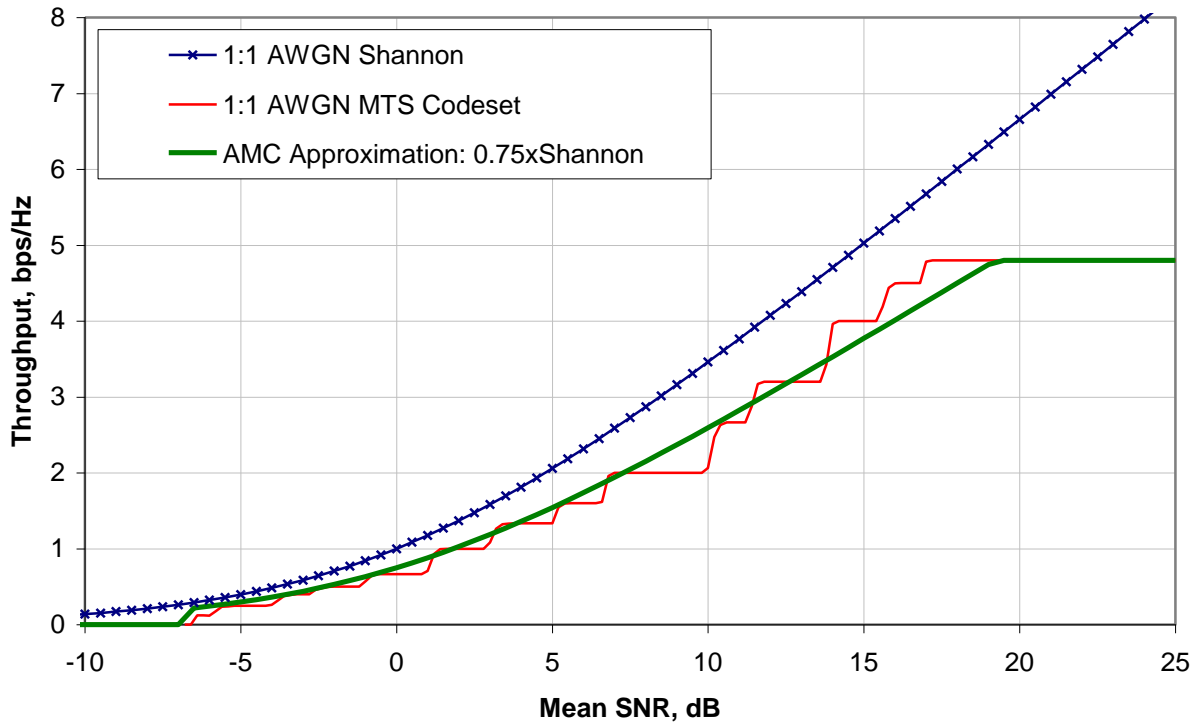

Figure A.5 Approximating AMC With an Attenuated and Truncated form of the Shannon Bound

The following equations approximate the throughput over a channel with a given SNR, when using AMC:

$$Throughput, Thr = \begin{cases} Thr = 0 & \text{for } SNIR < SNIR_{MIN} \\ Thr = \alpha \cdot S(SNIR) & \text{for } SNIR_{min} < SNIR < SNIR_{MAX} \\ Thr = Thr_{MAX} & \text{for } SNIR > SNIR_{MAX} \end{cases}$$

Where:

S(SNIR) is the Shannon bound:  $S(SNIR) = \log_2(1+SNIR)$

$\alpha$  Attenuation factor (0.75 for the example codeset)

$SNR_{MIN}$  Minimum SNIR of the codeset (-6.5dB for the example codeset)

$Thr_{MAX}$  Maximum throughput (4.8 bit/sec/Hz for the example codeset)

$SNIR_{MAX}$  SNIR at which max throughput is reached  $S^{-1}(Thr_{MAX})$  (17dB for the example codeset)

### A.3 UTRA 3.84 Mcps TDD HSDPA Link Level Performance

The throughput is derived from the HSDPA link level results of [8] and is found to match a truncated Shannon bound with an attenuation of 0.5. The HSDPA UTRA 3.84 Mcps TDD throughput is normalised to 15 timeslots and the spectral efficiency is found assuming a bandwidth of 5MHz. The spectral efficiency in table A.3 is presented as a function of the SINR in a timeslot. Figure A.6 shows the UTRA 3.84 Mcps TDD spectral efficiency as a function of SINR in a timeslot and the attenuated Shannon approximation. NOTE: RX Diversity is not employed.

Table A.3 SINR in a timeslot to spectral efficiency mapping

SINR in timeslot (dB)	spectral efficiency (bps / Hz)
-6.5	0.11
-3.5	0.22
-0.5	0.44

1.8	0.66
5.0	0.99
7.0	1.32
11.2	1.99
14.2	2.38

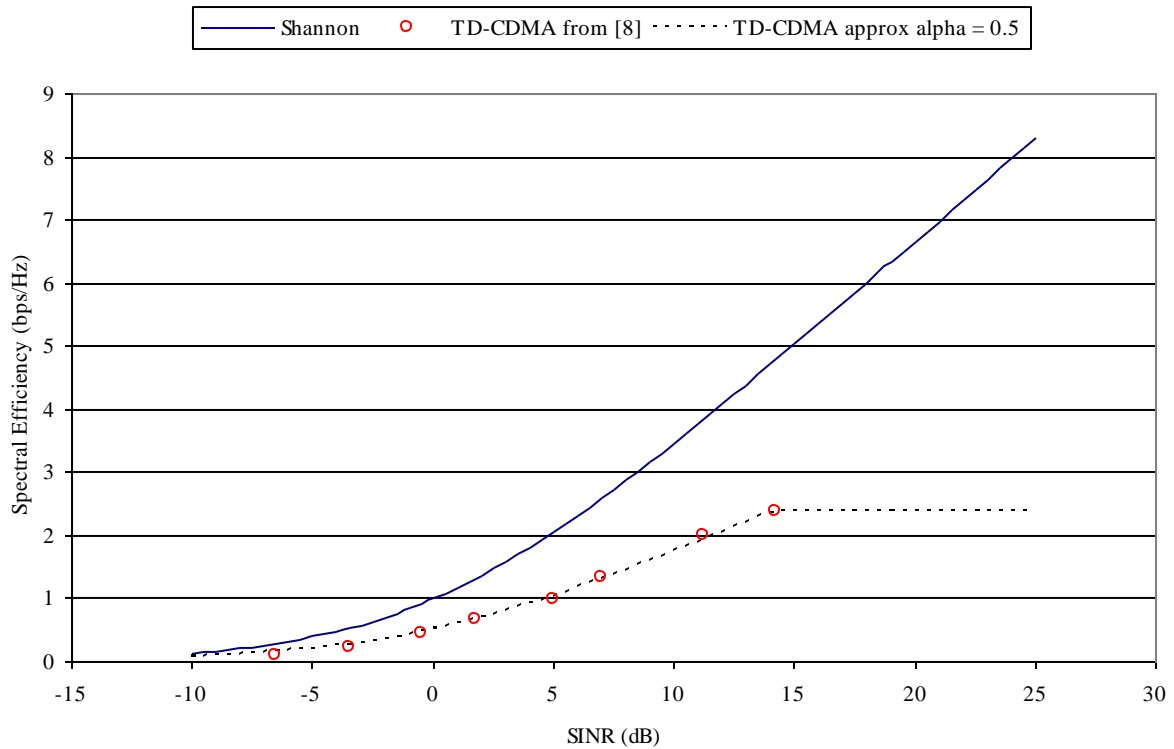

**Figure A.6 Throughput per DL Channel vs. SINR for Downlink UTRA 3.84 Mcps TDD (HSDPA)**

The attenuated Shannon approximation to UTRA 3.84 Mcps TDD spectral efficiency is based on the approach used for E-UTRA. The maximum spectral efficiency is derived assuming a code rate of 0.9 and 16QAM modulation. The Shannon approximation to UTRA 3.84 Mcps TDD spectral efficiency is:

$$Throughput, Thr, bps / Hz = \begin{cases} Thr = 0 & \text{for } SNIR < SNIR_{MIN} \\ Thr = \alpha \cdot S(SNIR) & \text{for } SNIR_{min} < SNIR < SNIR_{MAX} \\ Thr = Thr_{MAX} & \text{for } SNIR > SNIR_{MAX} \end{cases}$$

where the following parameters are applied:

**Table A.4 Parameters describing baseline UTRA 3.84 Mcps TDD performance Look-Up-table**

Parameter	DL	Notes
$\alpha$ , attenuation	0.5	Represents implementation losses
$SNIR_{MIN}$ , dB	-10	Based on QPSK, 1/12 rate (DL) without Rx Diversity
$Thru_{MAX}$ , bps/Hz	2.38	Based on 16QAM rate 0.9 (DL)
$SNIR_{MAX}$ , dB	14.20	

## A.4 Link Level Performance for E-UTRA TDD (LCR TDD frame structure based)

The throughput of a modem with link adaptation can be approximated by an attenuated and truncated form of the Shannon bound. (The Shannon bound represents the maximum theoretical throughput than can be achieved over an AWGN channel for a given SNR). The following equations approximate the throughput over a channel with a given SNR, when using link adaptation:

$$\text{Throughput, Thr, bps/Hz} = \begin{cases} \text{Thr} = 0 & \text{for SNIR} < \text{SNIR}_{\text{MIN}} \\ \text{Thr} = \alpha \cdot S(\text{SNIR}) & \text{for SNIR}_{\text{min}} < \text{SNIR} < \text{SNIR}_{\text{MAX}} \\ \text{Thr} = \text{Thr}_{\text{MAX}} & \text{for SNIR} > \text{SNIR}_{\text{MAX}} \end{cases}$$

Where:

$S(\text{SNIR})$  Shannon bound,  $S(\text{SNIR}) = \log_2(1 + \text{SNIR})$  bps/Hz

$\alpha$  Attenuation factor, representing implementation losses

$\text{SNR}_{\text{MIN}}$  Minimum SNIR of the codeset, dB

$\text{Thr}_{\text{MAX}}$  Maximum throughput of the codeset, bps/Hz

$\text{SNIR}_{\text{MAX}}$  SNIR at which max throughput is reached  $S^{-1}(\text{Thr}_{\text{MAX}})$ , dB

The parameters  $\alpha$ ,  $\text{SNR}_{\text{MIN}}$  and  $\text{THR}_{\text{MAX}}$  can be chosen to represent different modem implementations and link conditions. The parameters proposed in table 1 represent a baseline case, which assumes:

- 1:1 antenna configurations
- AWGN channel model
- Link Adaptation (see table A.X for details of highest and lowest rate codes)
- No HARQ

**Table A.5 Parameters describing baseline Link Level performance for E-UTRA TDD Co-existence simulations**

Parameter	UL	DL	Notes
$\alpha$ , attenuation	0.55	0.6	Represents implementation losses
$\text{SNIR}_{\text{MIN}}$ , dB	-4.9	-4.5	Based on BPSK, 1/7 rate for UL and QPSK 1/8 for DL
$\text{SNIR}_{\text{MAX}}$ , dB	11.45	16.72	Based on 16QAM, 4/5 rate
$\text{Thru}_{\text{MAX}}$ , bps/Hz	2.15	3.4	Based on 16QAM, 4/5 rate

Throughput vs. SNR curves are plotted in Figure A.7 for uplink and Figure A.8 for downlink. Table A.6 and table A.7 present throughput in terms of spectral efficiency (bps/Hz), and per 375kHz Resource Block (RB), in kbps.

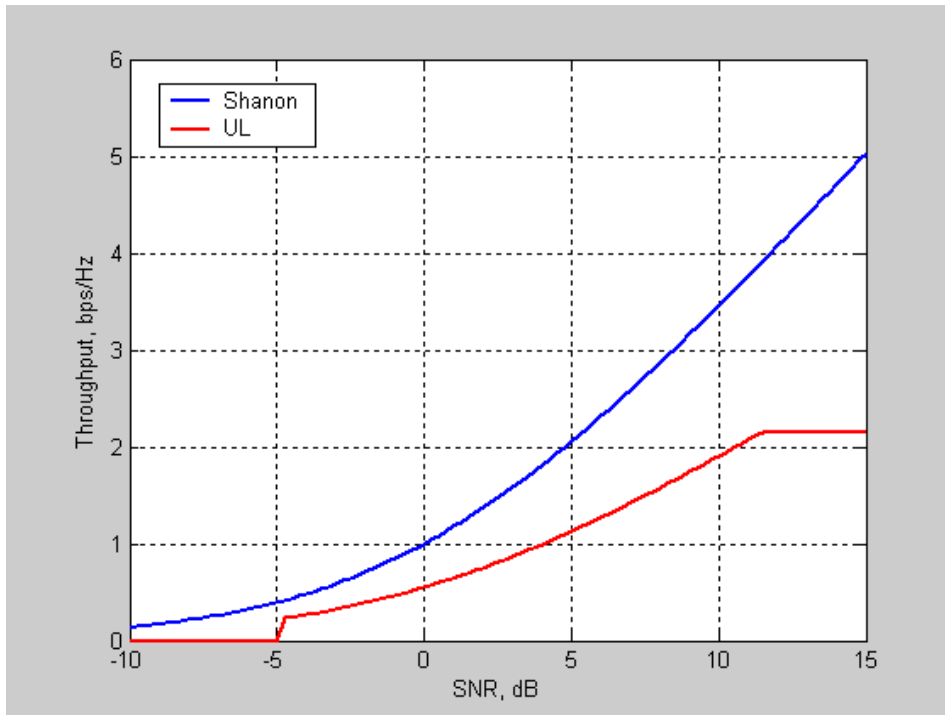

Figure A.7 Throughput vs SNR for Baseline E-UTRA Coexistence Studies for uplink

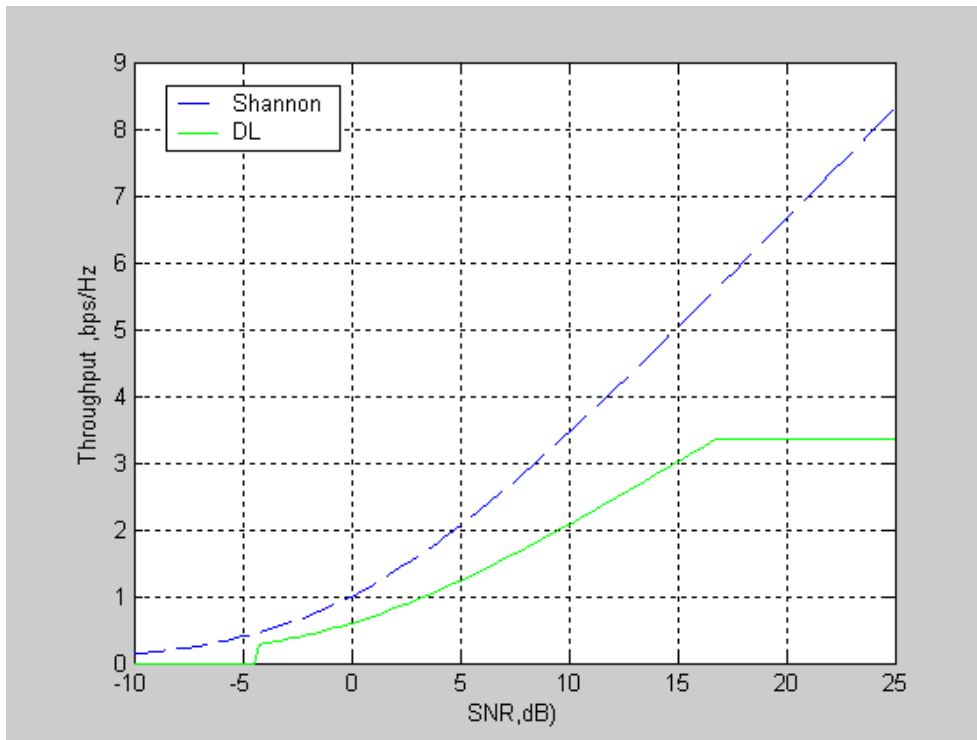

Figure A.8 Throughput vs SNR for Baseline E-UTRA Coexistence Studies for downlink

Table A.6 Look-Up-Table of UL Throughput vs SNIR for Baseline E-UTRA-TDD Coexistence Studies

SNIR(dB)	Throughput		SNIR(dB)	Throughput	
	bps/Hz	kbps per 375kHz RB		bps/Hz	kbps per 375kHz RB
-6	0	0	5	1.13	424.33
-5	0	0	6	1.27	477.77
-4	0.27	99.72	7	1.42	533.74
-3	0.32	120.88	8	1.58	591.89
-2	0.39	145.55	9	1.74	651.92
-1	0.46	173.96	10	1.90	713.51
0	0.55	206.25	11	2.07	776.41
1	0.65	242.48	12	2.15	805.07
2	0.75	282.58	13	2.15	805.07
3	0.87	326.43	14	2.15	805.07
4	1.00	373.78	15	2.15	805.07

Table A.7 Look-Up-Table of DL Throughput vs SNIR for Baseline E-UTRA-TDD Coexistence Studies

SNIR(dB)	Throughput		SNIR(dB)	Throughput	
	bps/Hz	kbps per 375kHz RB		bps/Hz	kbps per 375kHz RB
-7	0	0	7	1.6	584.3
-6	0	0	8	1.7	647.9
-5	0	0	9	1.9	713.6
-4	0.3	109.3	10	2.1	781.0
-3	0.4	132.3	11	2.3	849.9
-2	0.4	159.3	12	2.5	919.9
-1	0.5	190.4	13	2.6	990.9
0	0.6	225.8	14	2.8	1062.7
1	0.7	265.4	15	3.0	1135.1
2	0.8	309.3	16	3.2	1208.1
3	1.0	357.3	17	3.4	1260.9
4	1.1	409.2	18	3.4	1260.9
6	1.2	464.5	19	3.4	1260.9
7	1.4	523.0	20	3.4	1260.9

## Annex B (informative): Smart Antenna Model for UTRA 1.28 Mcps TDD

### B.1 Description

Considering beam forming function of smart antenna, the following five basic beam forming pattern is provided with their main beam pointing to  $0^\circ, 30^\circ, 45^\circ, 60^\circ$  and  $70^\circ$  respectively. The beam patterns pointing to  $-30^\circ, -45^\circ, -60^\circ$  and  $-70^\circ$  can be derived through the image of the above beam patterns. Thus, we can get nine angles beamforming radioation pattern. The gain of blow  $-90$  and above  $90$  is assumed as  $-\infty$  by using the ideal isolation. In the simulation each UE will select the most adjacent (in angle) beam pattern for signal strength and interference calculation accroding the the angle calculated from the UE position and BS sector antenna direction. For example if a UE 's angle to the direction of the sector is  $25^\circ$ , the  $30^\circ$  beam pattern will be selected. Then the selected beam pattern will be shifted  $-5^\circ$ , by which the main beam will pointing the UE. The signal strength and interference from different direction will be calculated based on the shifted pattern. The shifted angle out of  $[-90^\circ, 90^\circ]$  will be transfered inside  $[-90^\circ, 90^\circ]$  by horizontal imaging.

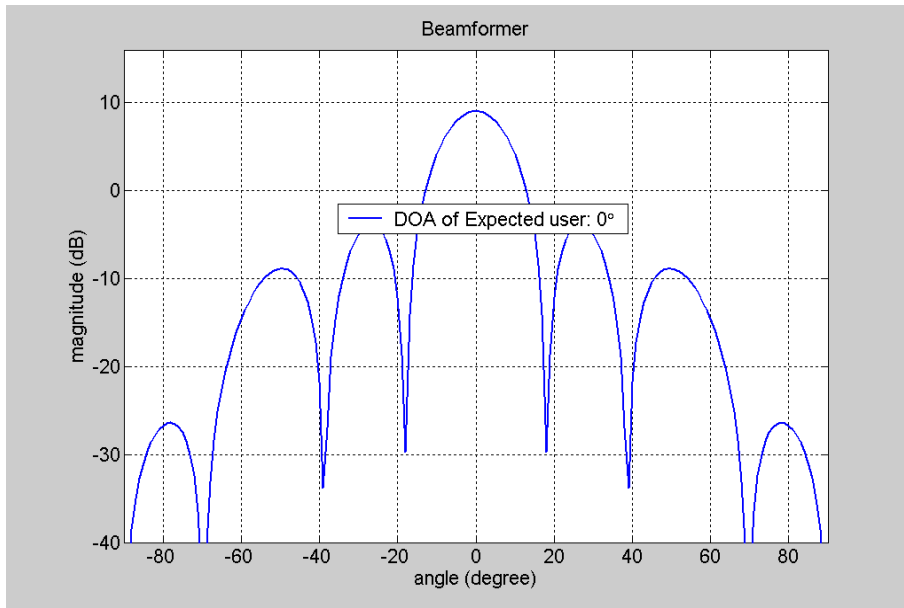

Figure B.1: 0° beam forming pattern

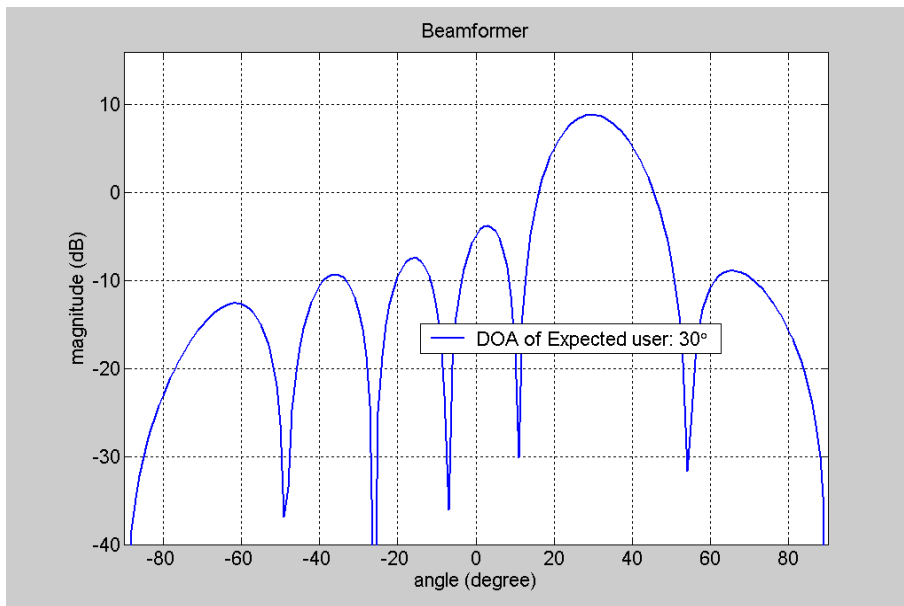

Figure B.2: 30° beam forming pattern



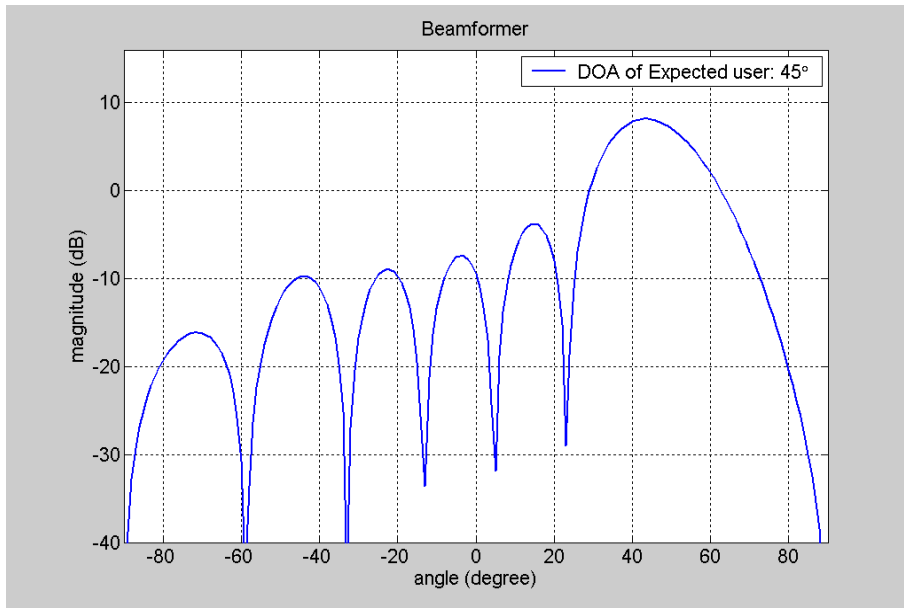

Figure B.3: 45° beam forming pattern

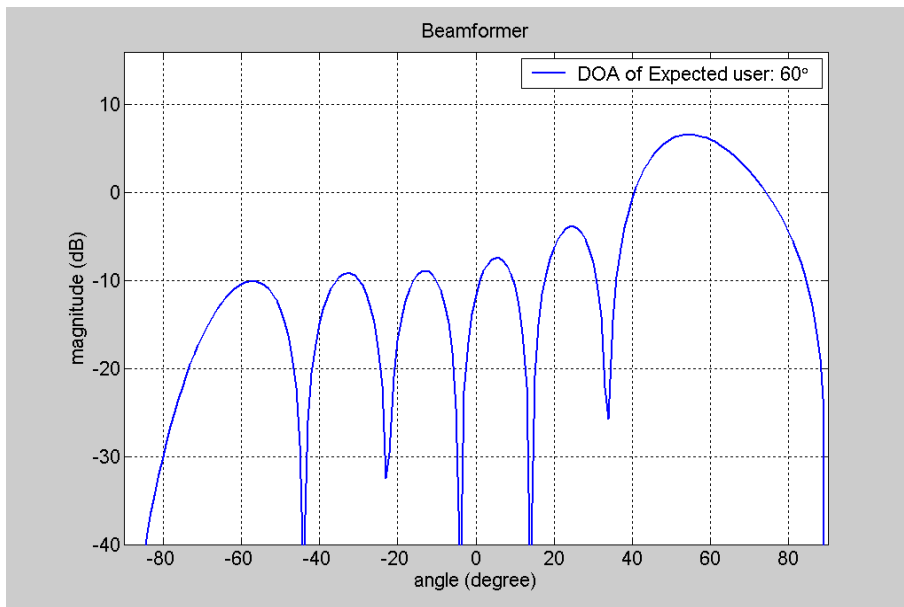

Figure B.4: 60° beam forming pattern

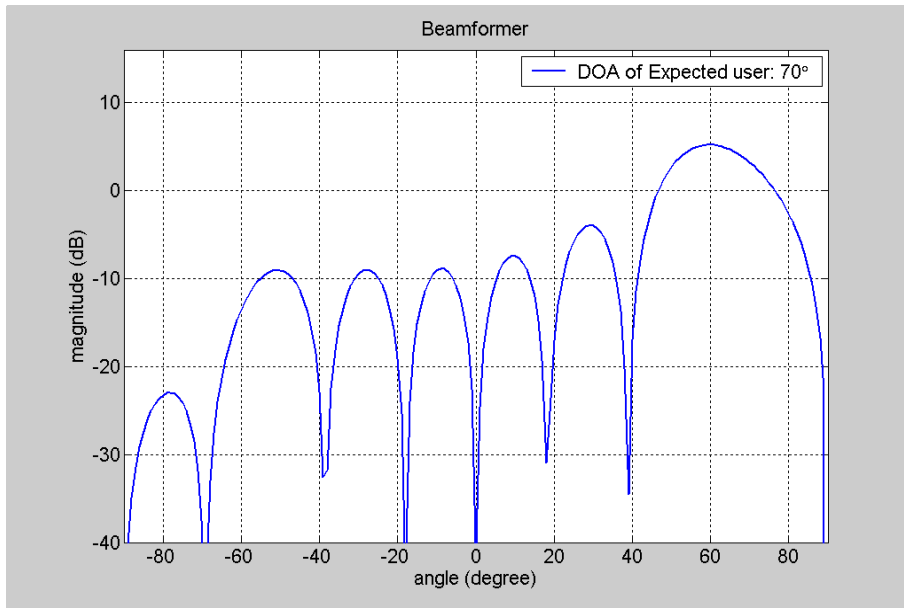

Figure B.5: 70° beam forming pattern

## Annex C (informative): Simulation assumptions for LTE-A coexistence

**Table C.1 Simulation assumptions for LTE-A coexistence**

Parameter	Assumption (common)
Environment	Macro cell, Urban area, Uncoordinated deployment
Carrier frequency	2000 MHz
Cellular layout	Hexagonal grid, 19 cell sites, 57 sectors with BTS in the corner of the cell , 65-degree sectored beam.
BTS antenna gain (include feeder loss)	15 dBi
BTS antenna frontback ratio ( $A_m$ )	20 dB
BTS antenna height	30 m
Inter-site distance	750 m
Pathloss model	$128.1+37.6\log_{10}(r) + 21*\log_{10}(f_c/2.0)$
log-normal fade shadow	10 dB
Shadowing correlation	Between cells: 0.5, Between sectors: 1.0
MCL (including antenna gain)	70 dB
Handover margin	3 dB
white noise power density	-174 dBm/Hz
BTS noise figure	5 dB
UE noise figure	9 dB
Scheduling algorithm	Round Robin
Parameter	Assumption (5 MHz UTRA)
system bandwidth	5 MHz
BS max Tx power	43 dBm
UE max Tx power	21 dBm
UE min Tx power	-50 dBm
Traffic model	speech (8kbps), full-buffer
non orthogonality factor	N/A (UL) 0.4 (DL)
Target Eb/N0	6.1 dB (UL) 7.9 dB (DL)
Parameter	Assumption (1.6 MHz UTRA)
system bandwidth	1.6 MHz
Smart antenna model	TR 36.942 Annex <B>
BS max Tx power	34 dBm
UE max Tx power	24 dBm
UE min Tx power	-49 dBm
Traffic model	speech (12.2kbps), full-buffer
non orthogonality factor	0.22 (UL)

	0.2 (DL)
Target SIR	-2.5 dB (UL) -2.5 dB (DL)
<b>Parameter</b>	<b>Assumption (LTE)</b>
system bandwidth	10 MHz
BS max Tx power	46 dBm
UE max Tx power	23 dBm
UE min Tx power	-40 dBm
Power control algorithm	Fractional TPC
$P_{0\text{PUSCH}}$	-101.0 dBm (TPC set1), -92.24 dBm (TCP set 2)
alpha	1.0 (TPC set 1), 0.8 (TPC set 2)
Traffic model	full-buffer
Resource Block (RB) size	180kHz, total: 50 RBs
RB number per active UEs	16 RBs (total: 48 RBs) (UL), 50 RBs (DL)
number of active UEs	3 UEs (UL), 1 UE (DL)
Link simulation interface	Attenuated and truncated form of the Shannon bound in TR36.942.doc
<b>Parameter</b>	<b>Assumption (LTE-A)</b>
system bandwidth	40 MHz
BS max Tx power	49 dBm
UE max Tx power	23 dBm
UE min Tx power	-40 dBm
Power control algorithm	Fractional TPC
$P_{0\text{PUSCH}}$	-101.0 dBm (TPC set1), -92.24 dBm (TCP set 2)
alpha	1.0 (TPC set 1), 0.8 (TPC set 2)
Traffic model	full-buffer
Resource Block (RB) size	180kHz, total: 200 RBs
RB number per active UEs	16 RBs (total: 192 RBs) (UL), 200 RBs (DL)
number of active UEs	12 UEs (UL), 1 UE (DL)
Link simulation interface	Attenuated and truncated form of the Shannon bound in TR36.942.doc

## Annex D (informative): Change history

Change history							
Date	TSG #	TSG Doc.	CR	Rev	Subject/Comment	Old	New
2005-11	R4 #37	R4-051134			TR created		
2006-02	R4 #38	R4-060353			Approved Documents included:R4-060301, R4-060347, R4-060348, R4-060349, R4-060350, R4-060351, R4-060352		0.1.0
2006-05	R4 #39	R4-060373			Approved Documents included:R4-060372, R4-060390	0.1.0	0.2.0
2006-05	R4 #39	R4-060641			Approved Documents included:R4-060639, R4-06040, R4-060673, R4-060674, R4-060680, R4-060699	0.2.0	0.3.0
2006-09	R4 #40	R4-061216			Approved Documents included:R4-061054, R4-061066, R4-060973, R4-061067	0.3.0	0.4.0
2006-11	R4 #41	R4-061359			Approved Documents included: R4-061312, R4-061319, R4-061344, R4-061366, R4-061374,	0.4.0	0.5.0
2007-02	R4#42	R4-070280			TR number 36.942 assigned	0.5.0	0.6.0
2007-02	R4#42	R4-070289			Approved Documents included: R4-070288, R4-070295, R4-070319	0.6.0	1.0.0
2007-04	R4#42bis	R4-070445			Editorial cleanup	1.0.0	1.0.1
2007-04	R4#42bis	R4-070457			Approved Documents included: R4-070459	1.0.1	1.1.0
2007-06	R4#44	R4-071172			Approved Documents included: R4-070931, R4-071146	1.1.0	1.2.0
2007-08	R4#44bis	R4-0711535			Approved Documents included: R4-071173, R4-071212	1.2.0	1.3.0
2007-10	R4#44bis	R4-071753			Approved Document included: R4-071535	1.3.0	1.4.0
2008-02	R4 #46	R4-080435			Approved Document included: R4-080309	1.4.0	1.5.0
2008-08	R4#48	R4-081728			Approved Document included: R4-081638	1.5.0	1.6.0
2008-08	R4#48	R4-082117			Approved Document included: R4-082085 Editorial clen-up.	1.6.0	1.7.0
2008-09	RP-41	RP-080592			Presentation for Approval	1.7.0	2.0.0
2008-09	RP-41	RP-080592			TR 36.942 V2.0.0	2.0.0	8.0.0
2008-12	RP-42	RP-080906	1		Rationales of unwanted emissions in TR 36.942	8.0.0	8.1.0
2008-12	RP-42	RP-080907	2	1	Correction of unwanted emission requirements for multi-carrier BS	8.0.0	8.1.0
2009-05	RP-44	RP-090544	3		Clarification of requirements for multicarrier BS	8.1.0	8.2.0
2009-12	SP-46				Automatic upgrade from previous Release	8.2.0	9.0.0
2010-04					Fix typo in version number on cover page	9.0.0	9.0.1
2010-06	RP-48	RP-100634	004	3	LTE-Advanced Co-existence	9.0.1	10.0.0
2010-09	RP-49	RP-100914	007	1	CR TR 36.942-10.0.0 Clause 5.1.1.4.1 Uplink Asymmetrical Bandwidths ACIR	10.0.0	10.1.0
2010-12	RP-50	RP-101344	010		CR TR 36.942 v10.1.0 annex A.4 Link Level Performance for E-UTRA TDD	10.1.0	10.2.0
2010-12	RP-50	RP-101359	009		Additional of LTE-Advanced co-existence simulation results (scenario #4)	10.1.0	10.2.0
2012-06	RP-56	RP-120778	011	1	Clarification of unwanted emissions requirements for TS 36.942 Rel-10	10.2.0	10.3.0
2012-06	RP-56	RP-120766	014	1	Clarification of uplink power control in TR36.942	10.2.0	10.3.0
2012-09	SP-57	-	-	-	Update to Rel-11 version (MCC)	10.3.0	11.0.0