

# 3GPP TS 28.627 V11.0.0 (2012-12)

---

*Technical Specification*

**3rd Generation Partnership Project;  
Technical Specification Group Services and System Aspects;  
Telecommunication Management;  
Self-Organizing Networks (SON) Policy  
Network Resource Model (NRM)  
Integration Reference Point (IRP);  
Requirements  
(Release 11)**

---



The present document has been developed within the 3<sup>rd</sup> Generation Partnership Project (3GPP™) and may be further elaborated for the purposes of 3GPP. The present document has not been subject to any approval process by the 3GPP Organizational Partners and shall not be implemented. This Specification is provided for future development work within 3GPP only. The Organizational Partners accept no liability for any use of this Specification. Specifications and reports for implementation of the 3GPP™ system should be obtained via the 3GPP Organizational Partners' Publications Offices.

---

Keywords

---

SON, Self-Optimization, Converged  
Management, FNIM, UIM

**3GPP**

Postal address

---

3GPP support office address

---

650 Route des Lucioles - Sophia Antipolis  
Valbonne - FRANCE  
Tel.: +33 4 92 94 42 00 Fax: +33 4 93 65 47 16

Internet

---

<http://www.3gpp.org>

---

**Copyright Notification**

No part may be reproduced except as authorized by written permission.  
The copyright and the foregoing restriction extend to reproduction in all media.

© 2012, 3GPP Organizational Partners (ARIB, ATIS, CCSA, ETSI, TTA, TTC).  
All rights reserved.

UMTS™ is a Trade Mark of ETSI registered for the benefit of its members  
3GPP™ is a Trade Mark of ETSI registered for the benefit of its Members and of the 3GPP Organizational Partners  
LTE™ is a Trade Mark of ETSI currently being registered for the benefit of its Members and of the 3GPP Organizational Partners  
GSM® and the GSM logo are registered and owned by the GSM Association

# Contents

Foreword .....	5
Introduction .....	5
1 Scope .....	6
2 References.....	6
3 Definitions and abbreviations .....	6
3.1 Definitions .....	6
3.2 Abbreviations.....	7
4 Concepts and background .....	7
4.1 Overview .....	7
4.2 Self-Optimization Concept.....	9
4.2.1 Logical Function Blocks .....	9
4.2.1.1 Self-Optimization Input Monitoring Function (SO_MON_F).....	9
4.2.1.2 Triggering Optimization Function (TG_F) .....	9
4.2.1.3 Optimization Fallback Function (O_FB_F) .....	9
4.2.1.4 Self-Optimization Progress Update Function (SO_PGS_UF) .....	9
4.2.1.5 NRM IRP Update Function (NRM_UF).....	9
4.2.1.6 Self-Optimization Monitoring and Management Function (SO_MMF).....	9
4.2.1.6.1 Self-Optimization Monitoring and Management Function (SO_MMF_NM).....	9
4.2.1.6.2 Self-Optimization Monitoring and Management Function (SO_MMF_EM) .....	9
4.2.1.7 Load Balancing Function (LB_F).....	10
4.2.1.8 Interference Control Function (IC_F) .....	10
4.2.1.9 Coverage and Capacity Function (CC_F).....	10
4.2.1.10 RACH Optimization Function (RACH_F).....	10
4.2.1.11 HandOver Optimization Function (HO_F) .....	10
4.3 SON Coordination Concepts .....	10
5 Business level requirements .....	10
5.1 Requirements.....	11
5.1.1 Self-Optimization Monitoring and Management.....	11
5.1.2 Load Balancing.....	11
5.1.3 Handover (HO) Parameter optimization .....	11
5.1.4 Interference control.....	12
5.1.5 Capacity and coverage optimization .....	12
5.1.6 RACH optimization .....	12
5.1.x SON Coordination.....	12
5.2 Actor roles .....	13
5.3 Telecommunications Resources.....	13
5.4 High-Level use case.....	13
5.4.1 Load Balancing.....	13
5.4.2 Interference control.....	15
5.4.3 Capacity and coverage optimization .....	16
6 Specification level requirements .....	17
6.1 Requirements.....	17
6.1.1 Self-Optimization Monitoring and Management.....	17
6.1.1.1 Management Part .....	17
6.1.2 Load Balancing.....	18
6.1.3 Handover (HO) Parameter optimization .....	18
6.1.3.1 HO failure categorization .....	18
6.1.3.1.1 HO failures due to too late and too early HO triggering .....	18
6.1.3.2 Reducing inefficient use of network resources due to unnecessary HOs .....	20
6.1.3.3 Requirements.....	21
6.1.4 Interference control.....	21
6.1.5 Capacity and coverage optimization .....	21
6.1.6 RACH optimization .....	21

6.1.7	SON Coordination.....	21
6.2	Actor roles .....	22
6.3	Telecommunications Resources.....	22
6.4	Use case.....	22
6.4.1	Use case Self-Optimization Monitoring and Management .....	22
6.4.2	Use case Load Balancing Allowed/Prohibited Management .....	22
7	Functions and Architecture .....	24
7.1	Self-Optimization Logical Architecture .....	24
7.2	Self-Optimization Reference Model .....	24
<b>Annex A (informative): Steps for SON self-optimization Technical Specifications.....</b>		<b>25</b>
<b>Annex B (informative): Change history .....</b>		<b>26</b>

---

## Foreword

This Technical Specification has been produced by the 3<sup>rd</sup> Generation Partnership Project (3GPP).

The contents of the present document are subject to continuing work within the TSG and may change following formal TSG approval. Should the TSG modify the contents of the present document, it will be re-released by the TSG with an identifying change of release date and an increase in version number as follows:

Version x.y.z

where:

- x the first digit:
  - 1 presented to TSG for information;
  - 2 presented to TSG for approval;
  - 3 or greater indicates TSG approved document under change control.
- y the second digit is incremented for all changes of substance, i.e. technical enhancements, corrections, updates, etc.
- z the third digit is incremented when editorial only changes have been incorporated in the document.

### Ready for Converged Management

This specification is part of a set that has been developed for converged management solutions.

---

## Introduction

The present document is part of a TS-family covering the 3<sup>rd</sup> Generation Partnership Project Technical Specification Group Services and System Aspects, Telecommunication management; as identified below:

- 28.627:** “Self-Organizing Networks (SON) Policy Network Resource Model (NRM) Integration Reference Point (IRP): Requirements”
- 28.628: “Self-Organizing Networks (SON) Policy Network Resource Model (NRM) Integration Reference Point (IRP): Information Service (IS)”
- 28.629: “Self-Organizing Networks (SON) Policy Network Resource Model (NRM) Integration Reference Point (IRP): Solution Set (SS) definitions”

---

# 1 Scope

The present document describes concept and requirements of SON Policy management for Self-Optimization and SON coordination.

---

## 2 References

The following documents contain provisions which, through reference in this text, constitute provisions of the present document.

- References are either specific (identified by date of publication, edition number, version number, etc.) or non-specific.
- For a specific reference, subsequent revisions do not apply.
- For a non-specific reference, the latest version applies. In the case of a reference to a 3GPP document (including a GSM document), a non-specific reference implicitly refers to the latest version of that document *in the same Release as the present document*.

- [1] 3GPP TS 32.101: "Telecommunication management; Principles and high level requirements".
- [2] 3GPP TS 32.102: "Telecommunication management; Architecture".
- [3] 3GPP TS 32.150: "Telecommunication management; Integration Reference Point (IRP) Concept and definitions".
- [4] 3GPP TR 21.905: "Vocabulary for 3GPP Specifications".
- [5] 3GPP TS 32.600: "Telecommunication management; Configuration Management (CM); Concept and high-level requirements".
- [6] 3GPP TS 28.620: "Telecommunication management; Fixed Mobile Convergence (FMC) Federated Network Information Model (FNIM) Umbrella Information Model (UIM)".

---

## 3 Definitions and abbreviations

### 3.1 Definitions

For the purposes of the present document, the terms and definitions given in 3GPP TS 32.101 [1], 3GPP TS 32.102 [2], 3GPP TS 32.150 [3] and the following apply. A term defined in the present document takes precedence over the definition of the same term, if any, in TS 32.101 [1], TS 32.102 [2], TS 32.150 [3] and TR 21.905 [4], in that order.

**Target:** Target provides a clear basis for assessing performance of self-optimization functions. Targets need to be carefully specified in terms of a series of performance measurements and/or KPIs, which can be specific, and which can be used also to identify problems. A target should be expressed in terms of a specific value or specific value range. The present document does not specify the specific value or desired value range of each target since those should be set by operators according to their policy and different network situation.

**Trigger condition:** The condition at which self-optimization should be triggered. Different self-optimization algorithms may have different trigger conditions for achieving same objectives and targets.

## 3.2 Abbreviations

For the purposes of the present document, the following abbreviations apply:

CCO	Capacity and Coverage Optimization
EM	Element Manager
eNodeB	evolved NodeB
EPC	Evolved Packet Core
E-UTRAN	Evolved Universal Terrestrial Radio Access Network
HO	Handover
ICIC	Inter Cell Interference Coordination
LB	Load Balancing
NE	Network Element
NM	Network Manager
NRM	Network Resource Model
OAM	Operation Administration Maintenance
PRB	Physical Resource Block
SON	Self Organizing Networks
UE	User Equipment

---

# 4 Concepts and background

## 4.1 Overview

A self-optimization functionality will monitor input data such as performance measurements, fault alarms, notifications etc. After analyzing the input data, optimization decisions will be made according to the optimization algorithms. Finally, corrective actions on the affected network node(s) will be triggered automatically or manually when necessary.

IRPManager should be able to control the self-optimization procedures according to the operator's objectives and targets.

The following diagram is illustrated how the self-optimization functionality works:

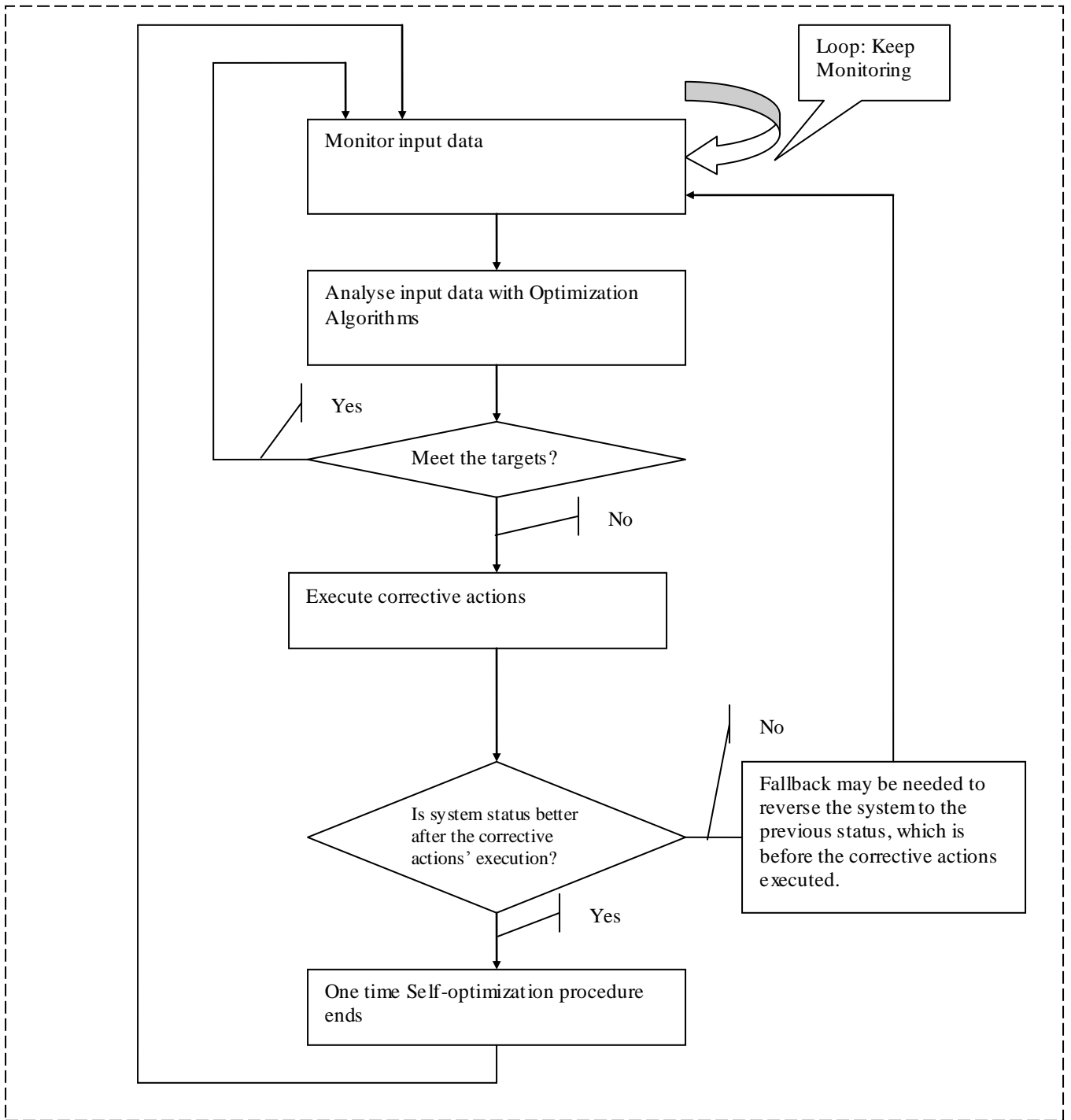

**Figure 4-1 Logical view of self-optimization procedure**

The self-optimization functionality working procedure could be interpreted logically as following:

1. The self-optimization functionality keeps monitoring input data according to the operator’s objectives and targets.
2. Whenever the objectives and targets are not met, optimization algorithms will be triggered.
3. Corrective actions are provided and executed.
4. Then the self-optimization functionality evaluates the result of the executed corrective actions.



- a) If the system status is not satisfactory after the corrective actions' execution, fallback may be needed to reverse the system configuration to the previous status, which is before the corrective actions executed.
- b) If the system status is satisfactory after the corrective actions' execution, the one time self-optimization procedure ends.

5. Self-optimization functionality returns to monitoring the input data.

## 4.2 Self-Optimization Concept

### 4.2.1 Logical Function Blocks

#### 4.2.1.1 Self-Optimization Input Monitoring Function (SO\_MON\_F)

This functional bloc supports the following functions: [SO1].

#### 4.2.1.2 Triggering Optimization Function (TG\_F)

This functional bloc supports the following functions: [SO2], [SO3].

#### 4.2.1.3 Optimization Fallback Function (O\_FB\_F)

This functional bloc supports the following functions: [SO7], [SO9], [SO10].

#### 4.2.1.4 Self-Optimization Progress Update Function (SO\_PGS\_UF)

This function updates the self-optimization progress and important events to the operator: [SO11]

#### 4.2.1.5 NRM IRP Update Function (NRM\_UF)

This function updates the E-UTRAN and EPC NRM IRP with the optimization modification if needed.

#### 4.2.1.6 Self-Optimization Monitoring and Management Function (SO\_MMF)

This function monitors the self-optimization process and provides the operator with this information. This function must be able to get information about all other functional blocs. In addition to this it allows the operator to control the execution of the self-optimization process.

This function also resolves conflicts of different SON functions trying to change or actually changing parameter values in different directions or reports such conflicts, if they cannot be solved.

##### 4.2.1.6.1 Self-Optimization Monitoring and Management Function (SO\_MMF\_NM)

SO\_MMF\_NM (IRP Manager): representing the NM portion of SO\_MMF (necessary monitoring and limited interaction capabilities to support an automated optimization), as well as related IRPManager functionality

In a centralized conflict resolution approach SO\_MMF\_NM identifies and resolves conflicts.

In distributed and hybrid conflict resolution approach SO\_MMF\_NM sends policy directions towards the SO\_MMF\_EM.

##### 4.2.1.6.2 Self-Optimization Monitoring and Management Function (SO\_MMF\_EM)

SO\_MMF\_EM (IRP Agent): representing the portion of SO\_MMF operating below Itf-N, as well as related IRPAgent functionality

In distributed and hybrid conflict resolution approach SO\_MMF\_EM identifies, resolves and/or reports conflicts, according to the policy directions received by SO\_MMF\_NM.

In case SO\_MMF\_EM is not able to solve a conflict, it will request the SO\_MMF\_NM to resolve the conflict.

#### 4.2.1.7 Load Balancing Function (LB\_F)

This function handles the load balancing optimization.

#### 4.2.1.8 Interference Control Function (IC\_F)

This function handles the interference control optimization.

#### 4.2.1.9 Coverage and Capacity Function (CC\_F)

This function handles the coverage and capacity optimization.

#### 4.2.1.10 RACH Optimization Function (RACH\_F)

This function handles the RACH optimization.

#### 4.2.1.11 HandOver Optimization Function (HO\_F)

This function handles the handover optimization.

### 4.3 SON Coordination Concepts

When multiple SON functions attempt to change some (same or associated) network configuration parameters of some (same or associated) nodes, one or more of these SON functions may not be able to achieve the operator's specified SON target(s) (for individual SON function) since they may have conflicting demands on network resources. This situation is considered as "SON functions in conflict" and requires conflict prevention or resolution. Detection of "SON functions in conflict" can be Use Case specific (for example, two SON functions make change at the same time or during the impact time interval).

The associated network configuration parameters include parameters within the same network element or parameters of different network elements with impact between each other. For example, the associated parameters of one cell are the parameters of its neighbour cells. Another typical association example is the TX power, antenna azimuth and tilt of one cell are associated with each other.

Different SON functions may have dependancies with each other. The behaviour of one SON function may have influence on other SON functions. For example, CCO function may adjust the Neighbour Relation due to coverage optimization, and then the changed NR will have an influence on Handover Parameter Optimization function.

SON coordination is to detect, prevent or resolve conflicts or negative influences between SON functions to make SON functions comply with operator's policy.

---

## 5 Business level requirements

The following general and high-level requirement applies for the present IRP:

- A. IRP-related requirements in 3GPP TS 32.101 [2].
- B. IRP-related requirements in 3GPP TS 32.102 [3].
- C. IRP-related requirements in 3GPP TS 32.600 [5].

The NRM defined by this IRP:

- D. Shall support communications for telecommunication network management purposes, including management of converged networks.

- E. Is a member of the Federated Network Information Model (FNIM) [6] and its information is derived from FNIM Umbrella Information Model (UIM) [6]

## 5.1 Requirements

### 5.1.1 Self-Optimization Monitoring and Management

**REQ-SO\_MM-CON-1** IRPManager shall be able to control the self-optimization functions.

**REQ-SO\_MM-CON-2** The self-optimization complex corrective actions shall be executed in a consistent and coordinated way.

**REQ-SO\_MM-CON-3** Self-optimization functions shall reuse existing standardized solutions as much as possible.

**REQ-SO\_MM-CON-4** void

**REQ-SO\_MM-CON-5** The IRPAgent shall support a capability allowing the IRPManager to know the success or failure result of Self-Optimization.

**REQ-SO\_MM-CON-6** The trigger conditions of self-optimization functions should be able to be managed by the IRPManager. The trigger condition may be the scheduled time to start a self-optimization function or a period of time during which a self-optimization function is forbidden to be started or the event (i.e. do not meet objectives or targets) to start a self-optimization function. Each self-optimization function shall have its own set of trigger condition.

**REQ-SO\_MM-CON-7** For the self-optimization functions which need continuous monitoring, the IRPManager should be able to manage the execution of self-optimization actions (e.g. setting a period of time during which a self-optimization action is forbidden to be executed).

**REQ-SO\_MM-CON-8** Each self-optimization function shall have one or several related performance indicator, which may be used as objective to evaluate the performance before the self-optimization is initiated and after the self-optimization function is completed.

**REQ-SO\_MM-CON-9** For operator controlled (open loop) SON function, the IRPAgent shall support a capability allowing IRPManager to know the information about the self-optimization actions. The necessity of this capability will be decided case by case.

**REQ-SO\_MM-CON-10** The IRPAgent shall support a capability allowing IRPManager to know the information about the execution result of self-optimization actions.

### 5.1.2 Load Balancing

**REQ-SO\_LB-CON-1** The optimization of load balancing shall be performed with minimal human intervention.

**REQ-SO\_LB-CON-2** The following scenarios shall be considered in optimization of load balancing. Each scenario shall include the load balancing on intra-frequency, inter-frequency, and inter-RAT.

1. Overlapping Coverage
2. Hierarchical Coverage
3. Neighbouring Coverage

### 5.1.3 Handover (HO) Parameter optimization

**REQ-SO\_HO-CON-1** HO parameter optimization shall be performed with no human intervention as much as possible.

**REQ-SO\_HO-CON-2** HO parameter optimization function shall aim at reducing the number of HO failures as well as reducing inefficient use of network resources due to unnecessary handovers. In particular, the HO parameter optimization function shall aim at reducing the number of HO related failures that cause degradation in user experience, such as call drops, radio link failures during or shortly after HO, and reduced data rates.

#### 5.1.4 Interference control

**REQ-SO\_IC-CON-1** Interference control shall be performed with as little human intervention as possible.

**REQ-SO\_IC-CON-2** The following scenarios shall be considered in interference control.

1. Uplink inter cell interference coordination
2. Downlink inter cell interference coordination

#### 5.1.5 Capacity and coverage optimization

**REQ-SO\_CC-CON-1** Coverage and capacity optimization shall be performed with minimal human intervention.

**REQ-SO\_CC-CON-2** Operator shall be able to configure the objectives and targets for the coverage and capacity optimisation function.

**REQ-SO\_CC-CON-3** Operator shall be able to configure the objectives and targets for the coverage and capacity optimisation functions differently for different areas of the network.

**REQ-SO\_CC-CON-4** The collection of data used as input into the coverage and capacity optimisation function shall be automated to the maximum extent possible and shall require minimum possible amount of dedicated resources.

**REQ-SO\_CC-CON-5** The following scenarios shall be considered in capacity and coverage optimization.

1. E-UTRAN Coverage holes with 2G/3G coverage
2. E-UTRAN Coverage holes without any other radio coverage
3. E-UTRAN Coverage holes with isolated island cell coverage
4. E-UTRAN cells with too large coverage

**REQ-SO\_CC-CON-6** The IRPAgent shall provide a capability allowing the IRPManager to manage tradeoffs between coverage and capacity using policies.

#### 5.1.6 RACH optimization

**REQ-SO\_RO-CON-1** RACH optimization shall be performed with minimal human intervention.

#### 5.1.x SON Coordination

**REQ-SON\_COORD-CON-1** SON coordination shall allow the prevention and resolution of conflicts between SON functions.

**REQ-SON\_COORD-CON-2** In case the SON coordination function is below Itf-N, the IRPAgent should support the capability for the IRPManager to define policies for the case that SON functions request conflicting parameter values. In case no policy is given, the IRPAgent shall apply default policies.

Note: A policy describes an expected behaviour from the IRPAgent. Examples for such policies:

- i) Prioritizing SON functions in case of conflicts
- ii) Assigning weights to SON targets
- iii) Prohibiting further changes of a parameter for a certain amount of time
- iv) Selecting preferred value ranges

- v) Telling the IRPAgent to report conflicts

**REQ-SON\_COORD-CON-3** For the case that the IRPAgent does not resolve the case of SON functions requesting conflicting values for parameters, the IRPAgent should support the capability for the IRPManager to decide about the parameter values.

**REQ-SON\_COORD-CON-4** The IRPAgent shall support a capability allowing the IRPManager to configure the SON coordination policy. The coordination includes the following aspects:

- 1) Coordination between SON functions below Itf-N and CM operations over Itf-N.
- 2) Coordination between different SON functions.

## 5.2 Actor roles

Managed system: The entity performing an IRPAgent role.

Managing system: The entity performing the IRPManager role.

## 5.3 Telecommunications Resources

The managed E-UTRAN/EPC network equipments are viewed as relevant telecommunications resources in this specification.

## 5.4 High-Level use case

### 5.4.1 Load Balancing

#### 1. Overlapping Coverage

In this scenario, two same size cells overlap each other. Cell A and cell B both cover the same area. The load balancing between cell A and Cell B may be considered. The load balancing could be carried out between Cell A and Cell B regardless of the UE location within the coverage of the cells.

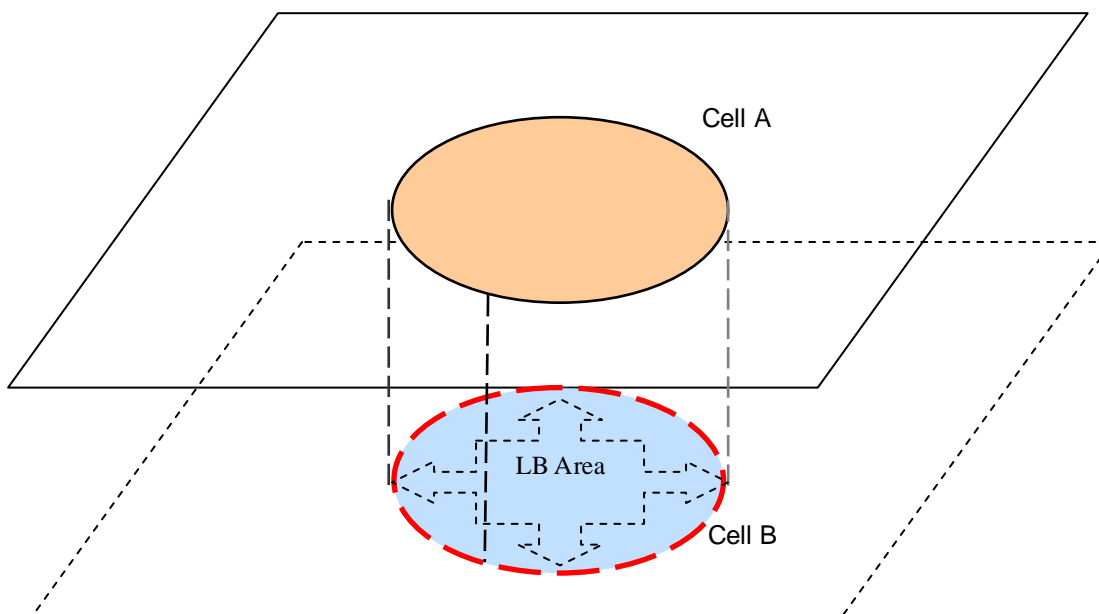

Figure 5.4.1-1: Overlapping Coverage

### Hierarchical Coverage

In this scenario, two different size cells overlap each other. Cell B that has a smaller area is covered totally by cell A, which has a bigger size. The load balancing between cell A and Cell B may be considered. The load balancing could be carried out from Cell B to Cell A regardless of the UE location within the coverage of the cell B. Only UE located in the overlapping coverage could be considered in the scenario of Cell A to Cell B.

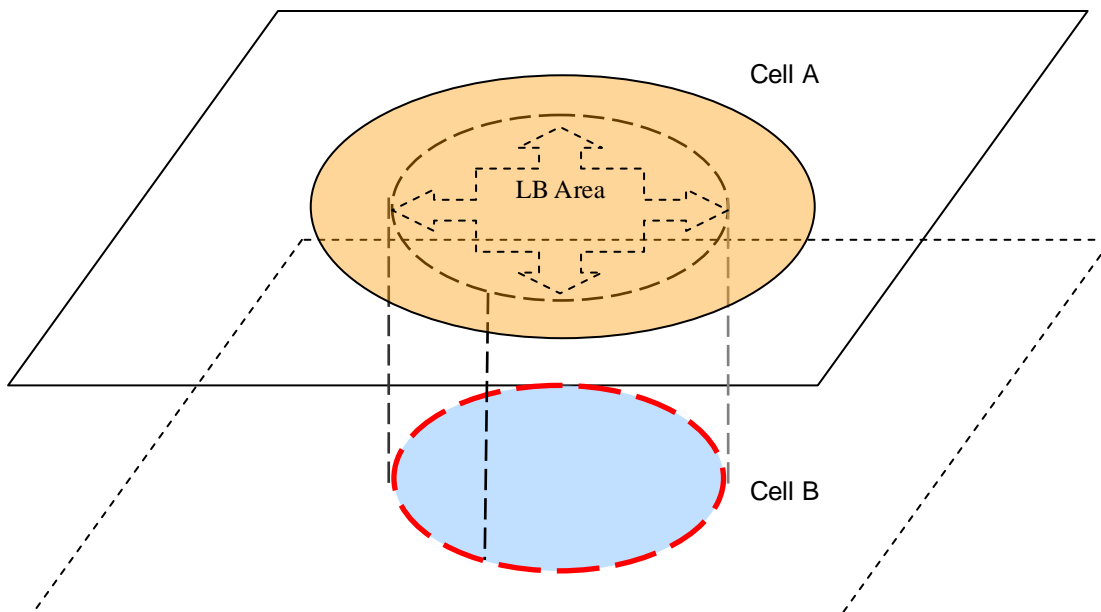

Figure 5.4.1-2: Hierarchical Coverage

### Neighbouring Coverage

In this scenario, there are some overlapped area between two neighbour cell A and cell B. This is the usual neighbour cells scenario in EUTRAN. The load balancing between cell A and Cell B may be considered. Load Balancing could only be carried out for UE located in the overlapping coverage of Cell A and Cell B.

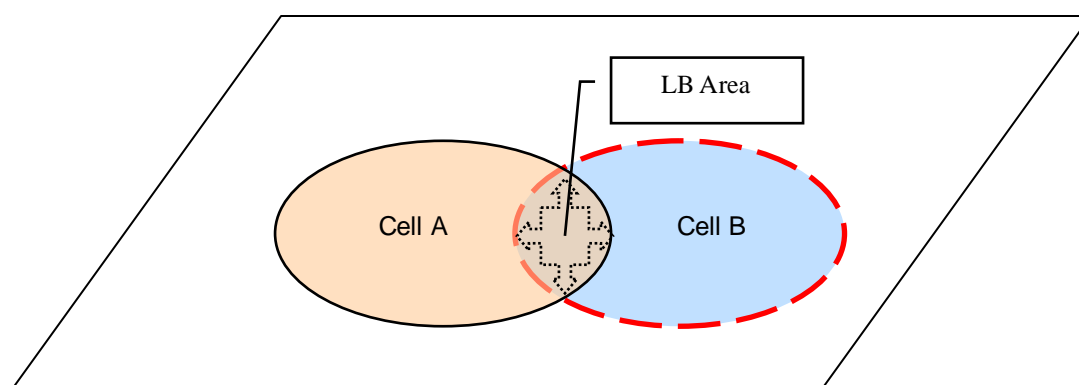

Figure 5.4.1-3: Neighbouring Coverage

### 5.4.2 Interference control

#### 1. Uplink inter cell interference coordination

In this scenario, cell-edge UEs like UE A and B belong to different cell, and they are assigned the same physical resource block (PRB). When they transmit uplink messages, e.g. UE A sends message to its serving cell A, its neighbour cell B may also receives it; UE B has a similar situation. Therefore, cell A cannot judge which is signal-comes from UE A, and which is interference-comes from UE B, so as cell B. In this situation, inter cell interference coordination is essential to compensate for the system performance loss and increase cell edge users' bit rate.

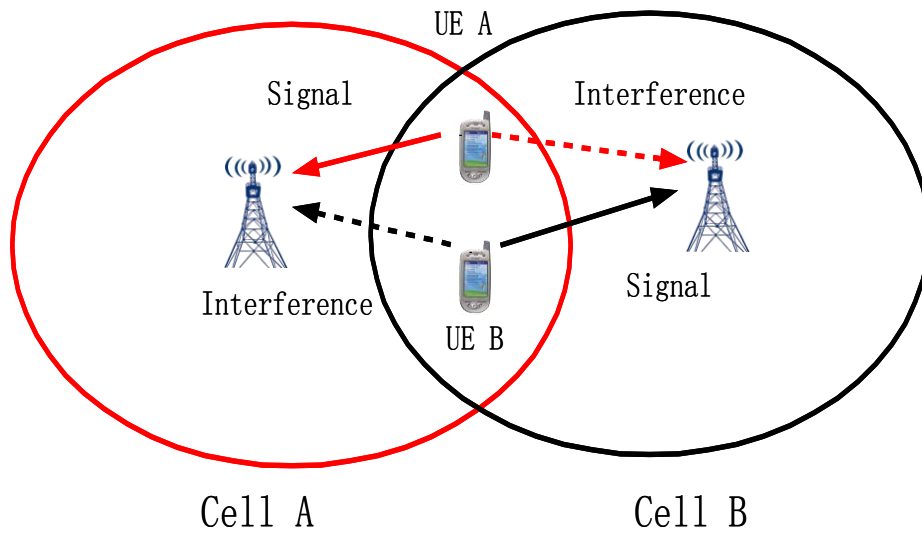

Figure 5.4.2-1: Uplink Inter Cell Interference Coordination

#### 2. Downlink inter cell interference coordination

In this scenario, when UE located in cell-edge area, it is much adapted to suffer downlink interference from its neighbour cell in case that there is another UE occupying the same PRB in the same region belonging to its neighbour cell. So downlink inter cell interference coordination is essential to restrain interference and increase system capacity.

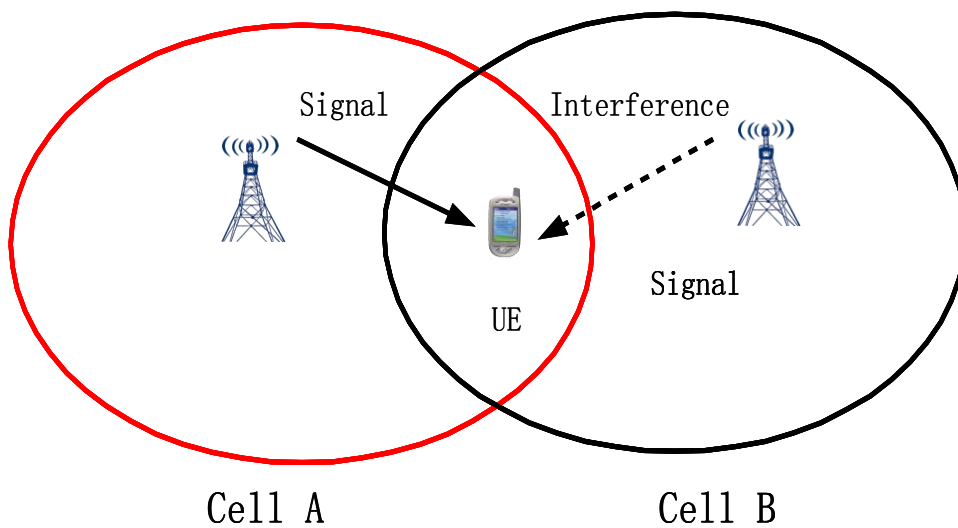

Figure 5.4.2-2: Downlink inter cell interference coordination

### 5.4.3 Capacity and coverage optimization

Although, it is of primary interest to provide coverage to users during a roll-out, it is equally important to enhance the capacity of the network during operation. As such, both coverage and capacity are considered in the use case and supported by the SON function. The CCO SON function should be configured through appropriate objectives and targets in order to meet the operator's requirement on coverage and capacity, and the prioritization between them.

#### 1. E-UTRAN Coverage holes with 2G/3G coverage

In this scenario, legacy systems, e.g. 2G/3G provide radio coverage together with E-UTRAN. However, in the first deployment stage of E-UTRAN, unsuitable planning or error parameters settings will lead to coverage holes in some area. In this scenario, there may be too many IRAT HOs. The SON use case coverage and capacity optimization should enable to detect this kind of problems on network coverage automatically. Another case similar with this is that coverage problems exist between different frequencies in E-UTRAN, i.e. inter-frequency case. For simple reasons, this case is also described here.

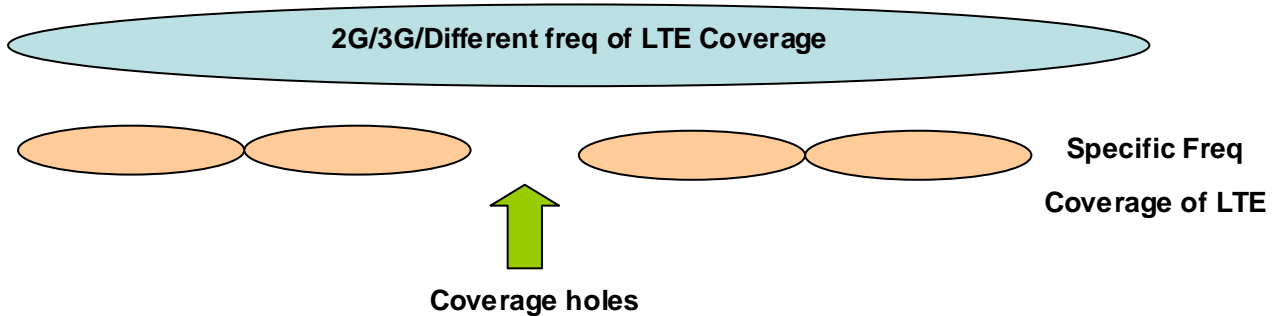

Figure 5.4.3-1: Coverage holes with 2G/3G coverage

#### 2. E-UTRAN Coverage holes without any other radio coverage

In this scenario, there is no 2G/3G coverage except E-UTRAN. In the first deployment stage of E-UTRAN, unsuitable planning or error parameters settings will lead to un-continuous coverage in some area. That will lead to many drop calls because of bad coverage. The SON use case coverage and capacity optimization should enable to detect this kind of problems on network coverage automatically.

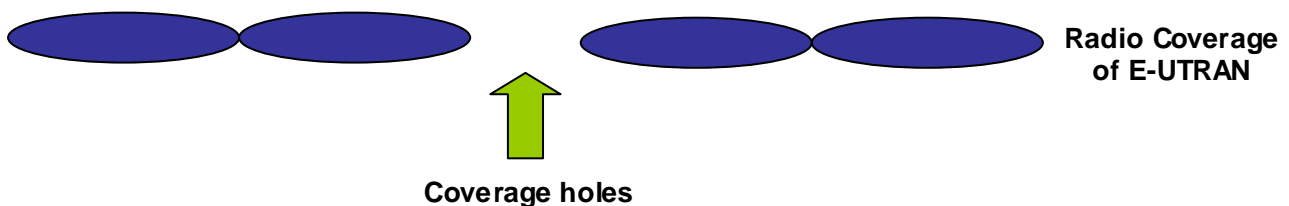

Figure 5.4.3-2: Coverage holes without any other radio coverage

#### 3. E-UTRAN Coverage holes with isolated island cell coverage

In this scenario, the actual coverage area of an isolated island cell is smaller than the planned isolated island cell area. The uncovered planned cell area is the coverage holes that need to be detected and optimized by the coverage and capacity optimization.



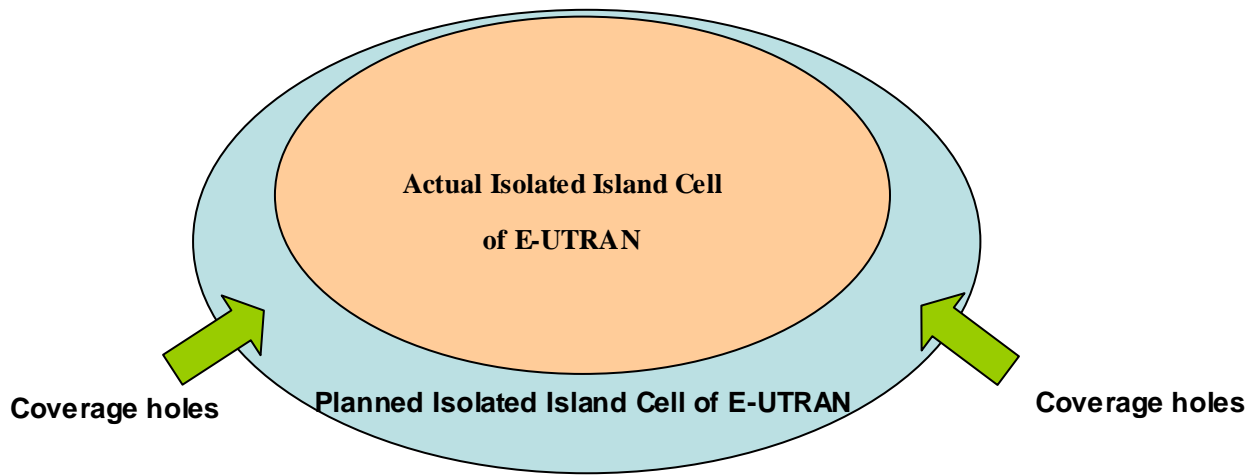

Figure 5.4.3-3: Coverage holes with isolated island cell coverage

4. E-UTRAN cells with too large coverage

In this scenario, the operator does a gradual network evolution using LTE cells in location where higher capacity is needed. Here the actual LTE coverage is greater than the planned LTE coverage. The overflow area is shown in figure 5.4.3.4. The problem with a too large coverage is that the planned capacity may not be reached. As such, it is important to keep the coverage within the planned area.

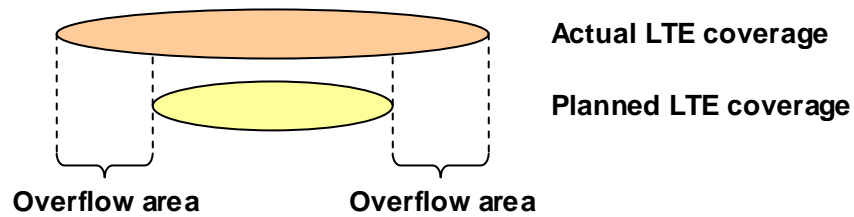

Figure 5.4.3-4: Difference between actual and planned LTE coverage

---

## 6 Specification level requirements

### 6.1 Requirements

#### 6.1.1 Self-Optimization Monitoring and Management

##### 6.1.1.1 Management Part

**REQ-SO\_MM-FUN-1** IRPManager shall be able to configure objectives and targets for the self-optimization functions.

**REQ-SO\_MM-FUN-2** For open loop, IRPManager shall be able to configure whether a confirmation is needed before the execution of optimization actions. The necessity of a confirmation will be decided case by case.

**REQ-SO\_MM-FUN-3** For open loop, IRPManager shall be able to confirm the execution of optimization actions in case IRPManager configured a confirmation is needed.

**REQ-SO\_MM-FUN-4** For open loop, IRPAgent shall provide information to the IRPManager about the optimization actions. The necessity of this capability will be decided case by case.

**REQ-SO\_MM-FUN-5** IRPAgent shall provide information to the IRPManager about the execution result of self-optimization actions.

**REQ-SO\_MM-FUN-6** The IRPAgent shall provide information to the IRPManager about the outcome of self-optimization.

**REQ-SO\_MM-FUN-7** IRPManager shall be able to configure the values of KPIs or performance counters which may be used to trigger the optimization function.

**REQ-SO\_MM-FUN-8** When the IRPAgent is aware of disruptive situations for the SON functionality, it shall support optimization functions in coping with them as much as possible without the need for an intervention from the IRPManager. Disruptive situations are e.g. an outage of a cell, the insertion of a new cell, deactivation of a cell etc.

## 6.1.2 Load Balancing

**REQ-SO\_LB-FUN-1** The IRPManager shall be able to disable/enable the load balancing function.

**REQ-SO\_LB-FUN-2** The IRPManager shall be informed about the eNodeB load.

**REQ-SO\_LB-FUN-3** The IRPManager shall be able to request that load balancing be allowed from source cell to target cell.

**REQ-SO\_LB-FUN-4** The IRPManager shall be able to request that load balancing be prohibited from source cell to target cell.

**REQ-SO\_LB-FUN-5** The IRPAgent shall inform the IRPManager about success or failure of IRPManager operations to allow load balancing, prohibit load balancing.

## 6.1.3 Handover (HO) Parameter optimization

### 6.1.3.1 HO failure categorization

#### 6.1.3.1.1 HO failures due to too late and too early HO triggering

HO failures can be categorized as follows:

- HO failures due to too late HO triggering
- HO failures due to too early HO triggering
- Failures due to HO to a wrong cell

Consequently, the HO parameter optimisation should aim at detecting and mitigating too early HOs, too late HOs and HOs to a wrong cell. The following subsections provide the scenarios for too early HO, too late HO and HO to a wrong cell triggering leading to HO failures.

##### 6.1.3.1.1.1 Too late HO triggering

Example scenario for too late HO triggering is shown in Figure 6-1. If the UE mobility is more aggressive than what the HO parameter settings allow for, the HO could be triggered when the signal strength of the serving cell is already too low or may not be triggered at all if a radio link failure preempts it. The connection may be re-established on a different cell from the serving cell. This is a common scenario in areas where user mobility is very high, such as along the highways, train lines etc.

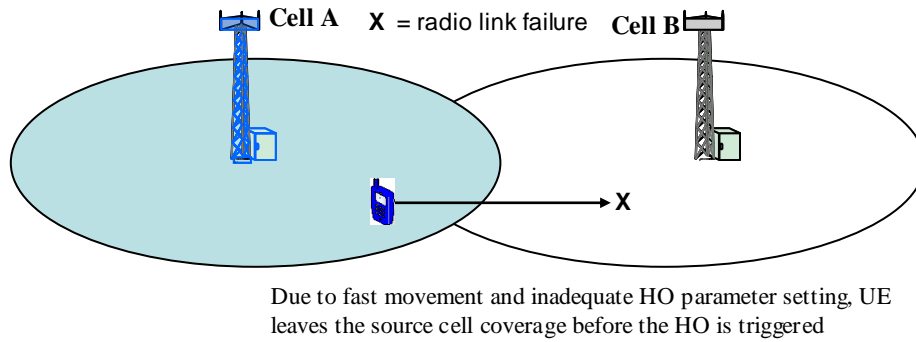

**Figure 6-1 – Too late HO triggering scenario**

6.1.3.1.1.2 Too early HO triggering

Example scenario for too early HO triggering is shown in Figure 6-2. HO can be triggered when the UE enters unintended island of coverage of the target cell inside the intended coverage area of the serving cell. When the UE exits the island of coverage of the target cell, it cannot acquire the target cell any more and the HO fails, potentially leading to a radio link failure. This is a typical scenario for areas where fragmented cell coverage is inherent to the radio propagation environment, such as dense urban areas.

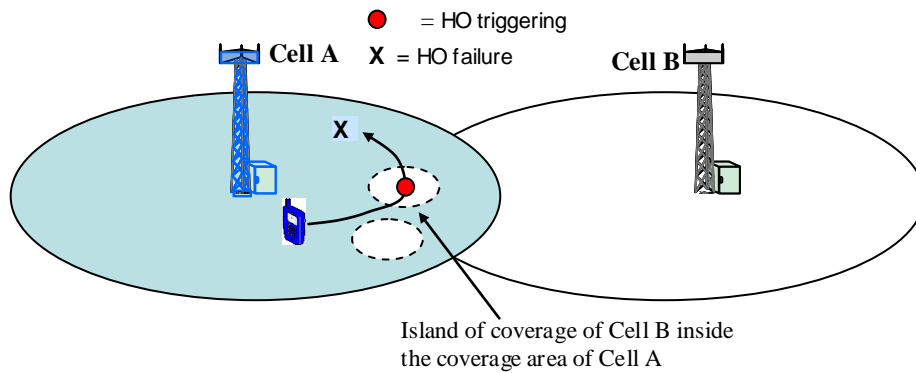

**Figure 6-2 – Too early HO triggering scenarios**

6.1.3.1.1.3 HO to a wrong cell

Example scenario for HO to a wrong cell is shown in Figure 6-3. In this scenario UE is moved from cell A to cell C, but because the HO parameter not optimized and a cell A sends a wrong HO command performs a handover to cell B and then a RLF happens. After that UE re-establishes connection with cell C.

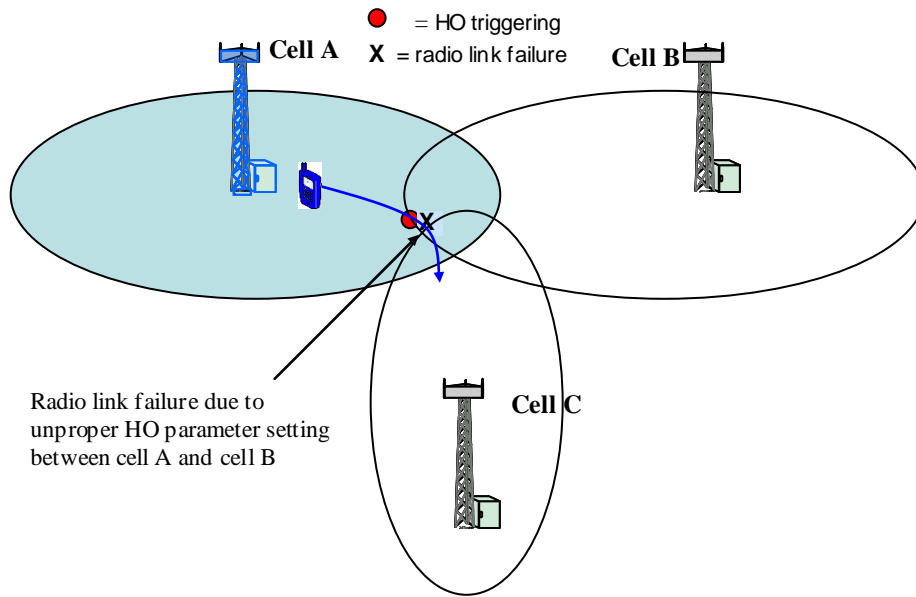

**Figure 6-3 –HO to a wrong cell scenarios**

**6.1.3.2 Reducing inefficient use of network resources due to unnecessary HOs**

HO procedure is resource-consuming and therefore costly to the network operator. Sometimes, the combination of user mobility patterns and cell coverage boundary layout can generate frequent unnecessary HOs that consume NW resources inefficiently. This scenario is illustrated in Figure 6-4a. HO parameter optimisation function should aim at detecting such scenarios. These scenarios sometimes can be remedied by HO parameter optimisation, as illustrated in Figure 6-4b. Since the goal of reducing unnecessary HOs can sometimes be opposed to the goal of reducing the number of HO failures, operators should be able to set the tradeoff point.

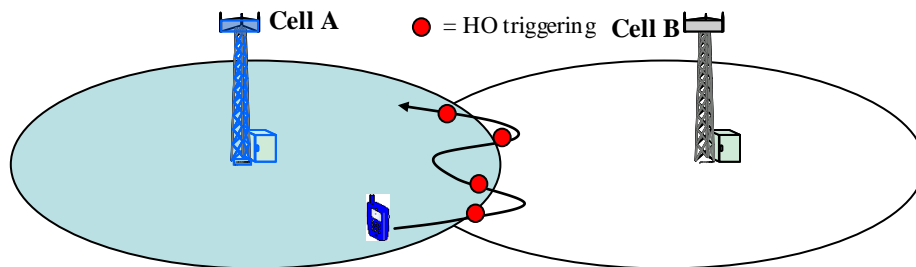

**Figure 6-4a – Frequent HOs cause inefficient use of NW resources**

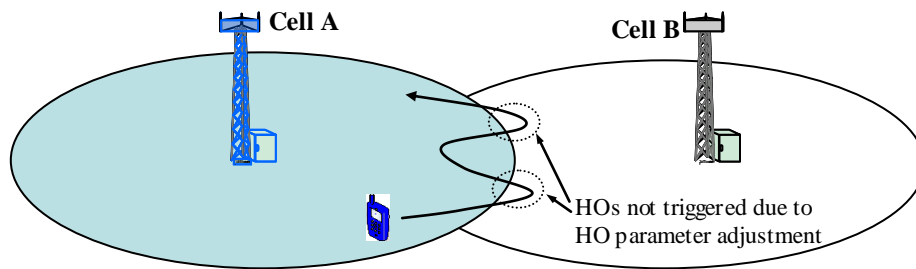

**Figure 6-4b – HO parameter adjustment prevents frequent Hos**

Additionally, incorrect cell reselection parameters setting may result unwanted handover right after RRC connection setup, HO parameter optimization function should also aim at detecting misalignment between cell reselection parameters and handover parameters setting and adjust the parameters to avoid such scenarios.

### 6.1.3.3 Requirements

**REQ-SO\_HO-FUN-1** HO parameter optimisation function shall aim at detecting too early handover, too late handover and handover to a wrong cell.

**REQ-SO\_HO-FUN-2** HO parameter optimisation function shall aim at detecting inefficient use of network resources due to unnecessary HOs.

**REQ-SO\_HO-FUN-3** HO parameter optimisation function shall aim at meeting the objectives and targets for the HO optimisation function

**REQ-SO\_HO-FUN-4** The objectives for the HO parameter optimisation function shall reflect the desired tradeoff between the reduction in the number of HO related failures and the reduction of inefficient use of network resources due to HOs.

**REQ-SO\_HO-FUN-5** The IRPManager shall be able to disable/enable the HO parameter optimization function.

### 6.1.4 Interference control

**REQ-SO\_IC-FUN-1** The IRPManager shall be able to disable/enable the Interference Control function.

**REQ-SO\_IC-FUN-2** The IRPManager shall be able to request that ICIC be allowed from source cell to target cell.

**REQ-SO\_IC-FUN-3** The IRPManager shall be able to request that ICIC be prohibited from source cell to target cell.

**REQ-SO\_IC-FUN-4** An IRPAgent shall inform the IRPManager about success or failure of IRPManager operations to allow ICIC, prohibit ICIC.

### 6.1.5 Capacity and coverage optimization

**REQ-SO\_CC-FUN-1** Performance measurements with geographical binning may be used as inputs into the coverage and capacity optimisation function.

**REQ-SO\_CC-FUN-2** CCO function shall aim at providing optimal capacity and coverage for the radio network while considering the tradeoff between capacity and coverage.

**REQ-SO\_CC-FUN-3** The IRPAgent shall support a capability allowing the IRPManager to enable or disable the CCO function.

### 6.1.6 RACH optimization

**REQ-SO\_RO-FUN-1** The IRPAgent shall support enabling and disabling the RACH optimization function.

### 6.1.7 SON Coordination

The following requirements apply when the SON coordination function is in NM layer.

**REQ-SON\_COORD-FUN-1** The IRPAgent shall provide the capability to inform the IRPManager whether a SON function is activated or not.

**REQ-SON\_COORD-FUN-2** The IRPAgent shall provide the capability to inform the IRPManager about which SON functions modified configuration parameter(s).

**REQ-SON\_COORD-FUN-3** The IRPAgent should provide the capability to inform the IRPManager about the time duration how long the configuration parameter(s) should not be modified.

**REQ-SON\_COORD-FUN-4** The IRPAgent should provide the capability to inform the IRPManager about the SON targets which are the justification for the configuration change.

The following requirements apply when the SON coordination function is below Itf-N.

**REQ-SON\_COORD-FUN-5** The IRPAgent should provide a capability to allow the IRPManager to configure the priority of SON functions in case of conflicts.

**REQ-SON\_COORD-FUN-6** The IRPAgent shall provide the capability for the IRPManager to be informed when the SON coordination function could not resolve a conflict. This information should include the involved SON functions, the involved configuration parameters and/or the involved SON targets.

## 6.2 Actor roles

No new actor.

## 6.3 Telecommunications Resources

No new telecommunications resources.

## 6.4 Use case

### 6.4.1 Use case Self-Optimization Monitoring and Management

Use Case Stage	Evolution / Specification	<<Uses>> Related use
Goal (*)	Optimize the system in an automated manner.	
Actors and Roles (*)	IRPManager as user	
Telecom resources	The E-UTRAN/EPC network including its management system.	
Assumptions	The network is properly installed and running.	
Pre conditions	The self-optimization objectives and targets have been set by operators	
Begins when	Based on the monitored input parameters (KPIs, Alarms, etc.), targets for the objectives defined for the self-optimization functions are not met.	
Step 1 (*) (M O)	The order of the bullet points in the list below does not imply any statements on the order of execution. [SO1] The input parameters (KPIs, Alarms, etc.) are monitored continuously. [SO2] When the monitored parameters do not meet the optimization targets, the optimization function is triggered. [SO3] Optimisation function proposes corrective actions. [SO4] Operator may confirm the execution/activation of the proposed actions if needed. [SO5] Corrective actions are executed. [SO6] Optimisation function monitors system status for a certain pre-defined monitoring time period. [SO7] The configuration prior to the corrective action is memorised if needed. [SO8] If the system status is satisfactory during the monitoring time period, then go to [SO1]. [SO9] Operator may confirm if fallback is needed. [SO10] Fallback is executed. [SO11] The operator is informed about the progress and important events occurring during the self-optimization process.	
Step n (M O)		
Ends when (*)	Ends when all steps identified above are successfully completed or when an exception occurs.	
Exceptions	One of the steps identified above fails and retry is unsuccessful..	
Post Conditions	System is operating normally.	
Traceability (*)	REQ-SO_MM-FUN-1, REQ-SO_MM-FUN-2, REQ-SO_MM-FUN-3, REQ-SO_MM-FUN-4, REQ-SO_MM-FUN-5, REQ-SO_MM-FUN-6	

### 6.4.2 Use case Load Balancing Allowed/Prohibited Management

Use Case Stage	Evolution / Specification	<<Uses>> Related use
Goal (*)	The load balancing (LB) can be allowed/prohibited from a source cell to a target cell by the IRPManager.	
Actors and Roles (*)	IRPManager as user	
Telecom resources	The E-UTRAN/EPC network including its OSS.	
Assumptions	There is operator's policy for LB allowing/prohibiting management. For example: LB from the higher priority cell to the lower priority cell is allowed; reverse is prohibited. LB between an eNB cell and another eNB cell which belongs to another unwanted PLMN is prohibited.	
Pre conditions	The network is operational.	
Begins when		
Step 1 (*) (M)	The IRPManager makes a decision to allow/prohibit LB from a source cell to a target cell: According to operator's policy, or According to some information got in run time. For example: LB would always fail between some particular cells in case of some inappropriate parameters setting. In that situation, the LB function located at eNB may make a decision to prohibit LB between these particular cells and notify this information to the IRPManager. After the CM parameters adjusting, the LB between those cells may be allowed again based on the good values of relative PM counters.	
Step 2 (*) (M)	The IRPAgent is instructed by the IRPManager to allow/prohibit LB from the source cell to the target cell.	
Step 3 (*) (M)	The LB is allowed / prohibited from the source cell to the target cell by the corresponding eNB(s).	
Step 4 (*) (M)	Reporting of the allowing/prohibiting LB operation result to the IRPManager.	
Ends when (*)	Ends when all steps identified above are completed or when an exception occurs.	
Exceptions	One of the steps identified above fails and retry is unsuccessful.	
Post Conditions	The LB is allowed/prohibited from a source cell to a target cell successfully or unsuccessfully.	
Traceability (*)	REQ-SO_LB-FUN-3, REQ-SO_LB-FUN-4, REQ-SO_LB-FUN-5	

## 7 Functions and Architecture

### 7.1 Self-Optimization Logical Architecture

The lines between the functional blocks do not indicate specific 3GPP interfaces.

For the abbreviations used, please see the headlines of clause 3.

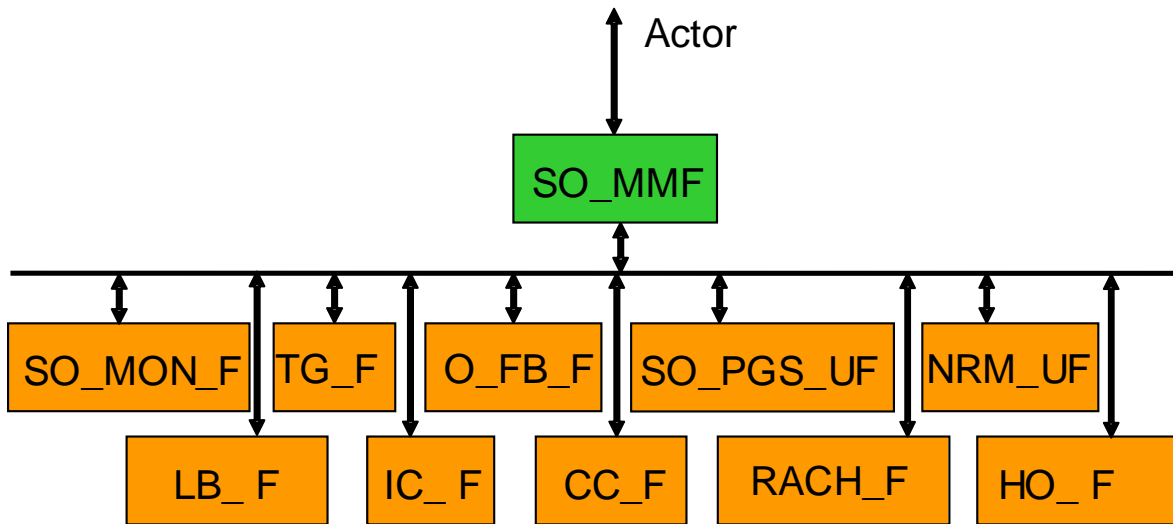

### 7.2 Self-Optimization Reference Model

The **SO\_MMF** has a part located in the EM and a part located at the NM.

For the abbreviations used, please refer to clause 3.

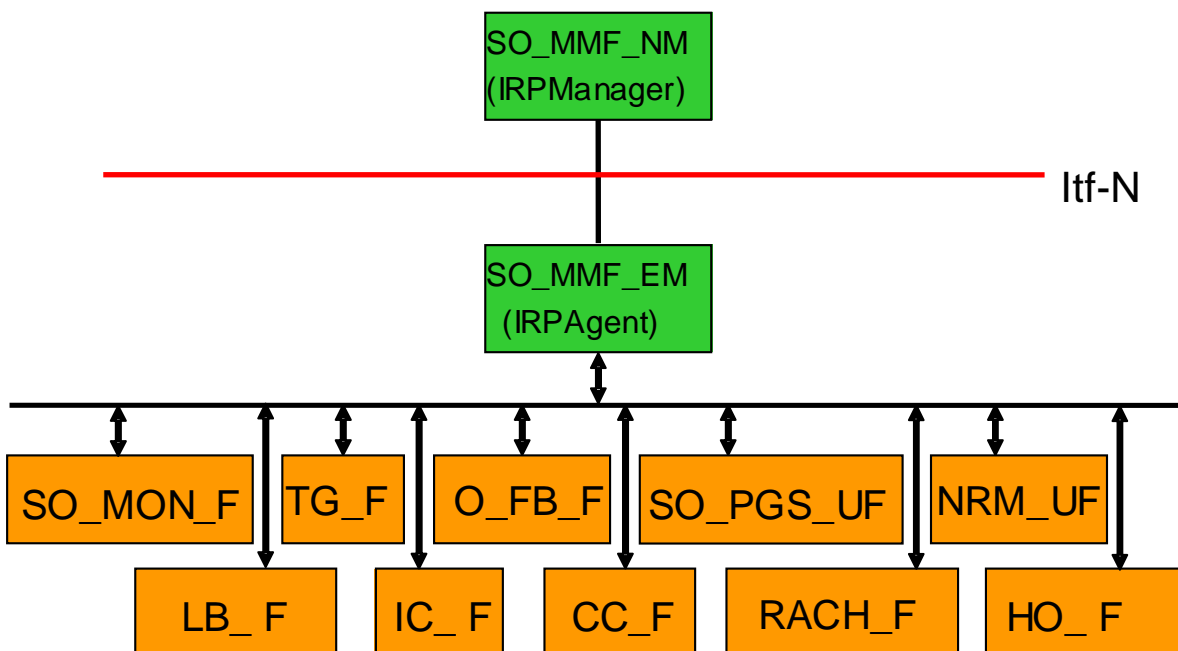



---

## Annex A (informative): Steps for SON self-optimization Technical Specifications

The TSs for SON self-optimization shall follow the steps below.

### 1. Goal

<The concise goal statement for the purpose of this self-optimization>

### 2. Problem Scenarios

The problem scenarios need to be optimized under the goal. This part may contain multiple problem scenarios

<PS 1...>

<PS 2...>

### 3. Parameters to be Optimized

The list of parameters needs to be optimized to resolve the problems under the goal. The parameters listed here are the overall parameters need to be optimized; it does not imply that all of the parameters are required to be open over Itf-N.

<Parameter 1, 2, 3...>

### 4. Architecture and Responsibilities

The suitable architecture to optimize the parameters above, it can be centralized, distributed or hybrid SON architectures.

And based on the architecture, the clear split of the responsibilities among NM, EM and NE should be stated here. This will result in the work split among 3GPP WGs.

### 5. Performance Measurements and NRMs

#### Performance measurements:

List of the performance measurements which are required via Itf-N to recognize the problem scenarios, and to monitor the result of self-optimization, based on the selected architecture and responsibilities.

This part only includes the descriptions for the performance measurements, and the detailed definitions will be defined in TS 32.425/32.426.

<Performance measurement 1>

<Performance measurement 2>

#### NRMs:

The parameters need to be modeled in NRM, to support the optimizations required over Itf-N according to the selected architecture and split responsibilities.

<Parameters 1, 2, ...>

---

## Annex B (informative): Change history

Change history							
Date	TSG #	TSG Doc.	CR	Rev	Subject/Comment	Old	New
Nov.2012					First draft		0.1.0
Dec 2012	SA#58				Submitted for information and approval	0.1.0	1.0.0
Dec 2012					New version after approval	1.0.0	11.0.0