

# ETSI TS 100 939 V7.3.0 (1999-12)

---

*Technical Specification*

**Digital cellular telecommunications system (Phase 2+);  
Mobile radio interface signalling layer 3;  
General aspects  
(GSM 04.07 version 7.3.0 Release 1998)**

---



---

**Reference**

RTS/SMG-030407Q7R1

---

**Keywords**

Digital cellular telecommunications system,  
Global System for Mobile communications  
(GSM)

**ETSI**

---

**Postal address**

F-06921 Sophia Antipolis Cedex - FRANCE

---

**Office address**

650 Route des Lucioles - Sophia Antipolis  
Valbonne - FRANCE  
Tel.: +33 4 92 94 42 00 Fax: +33 4 93 65 47 16  
Siret N° 348 623 562 00017 - NAF 742 C  
Association à but non lucratif enregistrée à la  
Sous-Préfecture de Grasse (06) N° 7803/88

---

**Internet**

secretariat@etsi.fr  
Individual copies of this ETSI deliverable  
can be downloaded from  
<http://www.etsi.org>  
If you find errors in the present document, send your  
comment to: editor@etsi.fr

---

**Important notice**

This ETSI deliverable may be made available in more than one electronic version or in print. In any case of existing or perceived difference in contents between such versions, the reference version is the Portable Document Format (PDF). In case of dispute, the reference shall be the printing on ETSI printers of the PDF version kept on a specific network drive within ETSI Secretariat.

---

**Copyright Notification**

No part may be reproduced except as authorized by written permission.  
The copyright and the foregoing restriction extend to reproduction in all media.

© European Telecommunications Standards Institute 1999.  
All rights reserved.

# Contents

Intellectual Property Rights.....	11
Foreword.....	11
1 Scope.....	12
2 References.....	12
3 Abbreviations.....	14
4 Introduction.....	14
4.1 General.....	14
4.2 Applicability of functional blocks.....	16
4.3 Technique of description.....	16
4.3.1 Service description.....	16
4.3.2 Abstract service primitives.....	16
4.3.3 Protocols and peer-to-peer communication.....	16
4.3.4 Contents of layer 3 related Technical Specifications.....	18
5 Structure of layer 3 functions.....	18
5.1 Basic groups of functions.....	18
5.2 Protocol architecture.....	19
6 Services provided by signalling layer 3 at the MS side.....	25
6.1 Registration services.....	25
6.1.1 Service state diagram for MS not supporting GPRS service.....	25
6.1.2 Service primitives.....	26
6.1.2.1 MMR_REG_REQ.....	26
6.1.2.2 MMR_REG_CNF.....	26
6.1.2.3 [reserved].....	26
6.1.2.4 MMR_NREG_REQ.....	26
6.1.2.5 MMR_NREG_IND.....	26
6.1.3 Registration Services for CTS-Services.....	27
6.1.3.1 MMR_CTS_ATTACH_REQ.....	27
6.1.3.2 MMR_CTS_ATTACH_CNF.....	27
6.1.3.3 MMR_CTS_ATTACH_REJ.....	27
6.1.3.4 MMR_CTS_DETACH_IND.....	27
6.1.3.5 MMR_CTS_ENROLL_REQ.....	27
6.1.3.6 MMR_CTS_ENROLL_CNF.....	27
6.1.3.7 MMR_CTS_ENROLL_REJ.....	27
6.1.3.8 MMR_CTS_DE_ENROLL_IND.....	27
6.2 Call Control services.....	28
6.2.1 Service state diagram.....	28
6.2.2 Service primitives.....	31
6.2.2.1 MNCC_SETUP_REQ.....	31
6.2.2.2 MNCC_SETUP_IND.....	31
6.2.2.3 MNCC_SETUP_RES.....	32
6.2.2.4 MNCC_SETUP_CNF.....	32
6.2.2.5 MNCC_SETUP_COMPL_REQ.....	32
6.2.2.6 MNCC_SETUP_COMPL_IND.....	32
6.2.2.7 MNCC_REJ_REQ.....	32
6.2.2.8 MNCC_REJ_IND.....	32
6.2.2.9 MNCC_CALL_CONF_REQ.....	32
6.2.2.10 MNCC_CALL_PROC_IND.....	32
6.2.2.11 MNCC_PROGRESS_IND.....	32
6.2.2.12 MNCC_ALERT_REQ.....	32
6.2.2.13 MNCC_ALERT_IND.....	32
6.2.2.14 MNCC_NOTIFY_REQ.....	32

6.2.2.15	MNCC_NOTIFY_IND .....	33
6.2.2.16	MNCC_DISC_REQ .....	33
6.2.2.17	MNCC_DISC_IND .....	33
6.2.2.18	MNCC_REL_REQ .....	33
6.2.2.19	MNCC_REL_IND .....	33
6.2.2.20	MNCC_REL_CNF .....	33
6.2.2.21	MNCC_FACILITY_REQ .....	33
6.2.2.22	MNCC_FACILITY_IND .....	33
6.2.2.23	MNCC_START_DTMF_REQ .....	33
6.2.2.24	MNCC_START_DTMF_CNF .....	33
6.2.2.25	MNCC_STOP_DTMF_REQ .....	33
6.2.2.26	MNCC_STOP_DTMF_CNF .....	33
6.2.2.27	MNCC_MODIFY_REQ .....	34
6.2.2.28	MNCC_MODIFY_IND .....	34
6.2.2.29	MNCC_MODIFY_RES .....	34
6.2.2.30	MNCC_MODIFY_CNF .....	34
6.2.2.31	MNCC_SYNC_IND .....	34
6.3	Call independent Supplementary Services Support .....	34
6.3.1	Service state diagram .....	34
6.3.2	Service primitives .....	35
6.3.2.1	MNSS_BEGIN_REQ .....	35
6.3.2.2	MNSS_BEGIN_IND .....	35
6.3.2.3	MNSS_FACILITY_REQ .....	35
6.3.2.4	MNSS_FACILITY_IND .....	35
6.3.2.5	MNSS_END_REQ .....	35
6.3.2.6	MNSS_END_IND .....	35
6.4	Short Message Services Support .....	35
6.5	Session Management Services for GPRS-Services .....	35
6.5.1	Session Management Services for SMREG-SAP .....	36
6.5.1.1	SMREG-PDP-ACTIVATE-REQ .....	36
6.5.1.2	SMREG-PDP-ACTIVATE-CNF .....	36
6.5.1.3	SMREG-PDP-ACTIVATE-REJ .....	36
6.5.1.4	SMREG-PDP-ACTIVATE-IND .....	36
6.5.1.5	SMREG-PDP-DEACTIVATE-REQ .....	37
6.5.1.6	SMREG-PDP-DEACTIVATE-CNF .....	37
6.5.1.7	SMREG-PDP-DEACTIVATE-IND .....	37
6.5.1.8	SMREG-PDP-MODIFY-IND .....	37
6.5.1.9	SMREG-AA-PDP-ACTIVATE-REQ .....	37
6.5.1.10	SMREG-AA-PDP-ACTIVATE-CNF .....	37
6.5.1.11	SMREG-AA-PDP-ACTIVATE-REJ .....	37
6.5.1.12	SMREG-AA-PDP-DEACTIVATE-REQ .....	37
6.5.1.13	SMREG-AA-PDP-DEACTIVATE-IND .....	37
6.5.2	Session Management Services for SNSM-SAP .....	39
6.5.2.1	Service primitives .....	39
6.5.2.1.1	SNSM-ACTIVATE-IND .....	39
6.5.2.1.2	SNSM-ACTIVATE-RSP .....	39
6.5.2.1.3	SNSM-DEACTIVATE-IND .....	39
6.5.2.1.4	SNSM-DEACTIVATE-RSP .....	39
6.5.2.1.5	SNSM-MODIFY-IND .....	39
6.5.2.1.6	SNSM-MODIFY-RSP .....	39
6.5.2.1.7	SNSM-STATUS-REQ .....	40
6.6	Registration Services for GPRS-Services .....	40
6.6.1	Registration Services for GMMREG-SAP .....	40
6.6.1.1	GMMREG-ATTACH-REQ .....	40
6.6.1.2	GMMREG-ATTACH-CNF .....	40
6.6.1.3	GMMREG-ATTACH-REJ .....	40
6.6.1.4	GMMREG-DETACH-REQ .....	40
6.6.1.5	GMMREG-DETACH-CNF .....	41
6.6.1.6	GMMREG-DETACH-IND .....	41

6.7	Services provided to SNDCP entities by GPRS Logical Link Control services .....	41
6.7.1	Service state diagram for QoS1-SAP, QoS2-SAP, QoS3-SAP and QoS4-SAP.....	42
6.7.2	Service primitives for QoS1-SAP, QoS2-SAP, QoS3-SAP and QoS4-SAP.....	43
6.7.2.1	LL-ESTABLISH-REQ.....	43
6.7.2.2	LL-ESTABLISH-CNF.....	43
6.7.2.3	LL-ESTABLISH-IND.....	43
6.7.2.4	LL-ESTABLISH-RSP.....	43
6.7.2.5	LL-RELEASE-REQ.....	44
6.7.2.6	LL-RELEASE-CNF.....	44
6.7.2.7	LL-RELEASE-IND.....	44
6.7.2.8	LL-XID-REQ.....	44
6.7.2.9	LL-XID-IND.....	44
6.7.2.10	LL-XID-RSP.....	44
6.7.2.11	LL-XID-CNF.....	44
6.7.2.12	LL-DATA-REQ.....	44
6.7.2.13	LL-DATA-CNF.....	44
6.7.2.14	LL-DATA-IND.....	44
6.7.2.15	LL-UNITDATA-REQ.....	44
6.7.2.16	LL-UNITDATA-IND.....	44
6.7.2.17	LL-STATUS-IND.....	44
6.8	Location services at the MS side .....	45
6.8.1	Service state diagram.....	45
6.8.2	Service primitives.....	45
6.8.2.1	MNLCS_BEGIN_REQ.....	46
6.8.2.2	MNLCS_BEGIN_IND.....	46
6.8.2.3	MNLCS_FACILITY_REQ.....	46
6.8.2.4	MNLCS_FACILITY_IND.....	46
6.8.2.5	MNLCS_END_REQ.....	46
6.8.2.6	MNLCS_END_IND.....	46
7	Services provided by signalling layer 3 on the Network side.....	46
7.1	Call control services .....	46
7.1.1	Service state diagram.....	47
7.1.2	Service primitives.....	49
7.1.2.1	MNCC_SETUP_REQ.....	49
7.1.2.2	MNCC_SETUP_IND.....	49
7.1.2.3	MNCC_SETUP_RSP.....	49
7.1.2.4	MNCC_SETUP_CNF.....	50
7.1.2.5	MNCC_SETUP_COMPL_REQ.....	50
7.1.2.6	MNCC_SETUP_COMPL_IND.....	50
7.1.2.7	MNCC_REJ_REQ.....	50
7.1.2.8	MNCC_REJ_IND.....	50
7.1.2.9	MNCC_CALL_CONF_IND.....	50
7.1.2.10	MNCC_CALL_PROC_REQ.....	50
7.1.2.11	MNCC_PROGRESS_REQ.....	50
7.1.2.12	MNCC_ALERT_REQ.....	50
7.1.2.13	MNCC_ALERT_IND.....	50
7.1.2.14	MNCC_NOTIFY_REQ.....	50
7.1.2.15	MNCC_NOTIFY_IND.....	50
7.1.2.16	MNCC_DISC_REQ.....	51
7.1.2.17	MNCC_DISC_IND.....	51
7.1.2.18	MNCC_REL_REQ.....	51
7.1.2.19	MNCC_REL_IND.....	51
7.1.2.20	MNCC_REL_CNF.....	51
7.1.2.21	MNCC_FACILITY_REQ.....	51
7.1.2.22	MNCC_FACILITY_IND.....	51
7.1.2.23	MNCC_START_DTMF_IND.....	51
7.1.2.24	MNCC_START_DTMF_RSP.....	51
7.1.2.25	MNCC_STOP_DTMF_IND.....	51

7.1.2.26	MNCC_STOP_DTMF_RSP.....	51
7.1.2.27	MNCC_MODIFY_REQ.....	51
7.1.2.28	MNCC_MODIFY_IND.....	51
7.1.2.29	MNCC_MODIFY_RES.....	52
7.1.2.30	MNCC_MODIFY_CNF.....	52
7.2	Call independent Supplementary Services Support.....	52
7.2.1	Service state diagram.....	52
7.2.2	Service primitives.....	53
7.2.2.1	MNSS_BEGIN_REQ.....	53
7.2.2.2	MNSS_BEGIN_IND.....	53
7.2.2.3	MNSS_FACILITY_REQ.....	53
7.2.2.4	MNSS_FACILITY_IND.....	53
7.2.2.5	MNSS_END_REQ.....	53
7.2.2.6	MNSS_END_IND.....	53
7.3	Short Message Services Support.....	53
7.4	Services provided to SMDCP and SMS entities by GPRS Logical Link Control services.....	53
7.4.1	Service state diagram for QoS1-SAP, QoS2-SAP, QoS3-SAP and QoS4-SAP.....	54
7.4.2	Service primitives for QoS1-SAP, QoS2-SAP, QoS3-SAP and QoS4-SAP.....	54
7.4.2.1	LL-ESTABLISH-REQ.....	54
7.4.2.2	LL-ESTABLISH-CNF.....	54
7.4.2.3	LL-ESTABLISH-IND.....	54
7.4.2.4	LL-ESTABLISH-RSP.....	55
7.4.2.5	LL-RELEASE-REQ.....	55
7.4.2.6	LL-RELEASE-CNF.....	55
7.4.2.7	LL-RELEASE-IND.....	55
7.4.2.8	LL-XID-REQ.....	55
7.4.2.9	LL-XID-IND.....	55
7.4.2.10	LL-XID-RSP.....	55
7.4.2.11	LL-XID-CNF.....	55
7.4.2.12	LL-DATA-REQ.....	55
7.4.2.13	LL-DATA-SENT-IND.....	55
7.4.2.14	LL-DATA-CNF.....	55
7.4.2.15	LL-DATA-IND.....	55
7.4.2.16	LL-UNITDATA-REQ.....	55
7.4.2.17	LL-UNITDATA-IND.....	55
7.4.2.18	LL-STATUS-IND.....	56
7.5	Session Management Services for GPRS.....	56
7.5.1	Session Management Services for SMREG-SAP.....	56
7.5.1.1	SMREG-PDP-ACTIVATE-REQ.....	56
7.5.1.2	SMREG-PDP-ACTIVATE-REJ.....	56
7.5.1.3	SMREG-PDP-DEACTIVATE-REQ.....	56
7.5.1.4	SMREG-PDP-DEACTIVATE-CNF.....	56
7.5.1.5	SMREG-PDP-MODIFY-REQ.....	56
7.5.1.6	SMREG-PDP-MODIFY-CNF.....	57
7.5.1.7	SMREG-PDP-MODIFY-REJ.....	57
7.5.2	Session Management Services for SNSM-SAP.....	57
7.5.2.1	SNSM-ACTIVATE-IND.....	57
7.5.2.2	SNSM-ACTIVATE-RSP.....	57
7.5.2.3	SNSM-DEACTIVATE-IND.....	57
7.5.2.4	SNSM-DEACTIVATE-RSP.....	57
7.5.2.5	SNSM-MODIFY-IND.....	58
7.5.2.6	SNSM-MODIFY-RSP.....	58
7.5.2.7	SNSM-STATUS-REQ.....	58
7.5.2.8	SNSM-WINDOW-IND.....	58
7.6	<b>Location services at the Network side.....</b>	<b>58</b>
7.6.1	Service state diagram.....	58
7.6.2	Service primitives.....	59
7.6.2.1	MNLCS_BEGIN_REQ.....	59
7.6.2.2	MNLCS_BEGIN_IND.....	60

7.6.2.3	MNLCS_FACILITY_REQ.....	60
7.6.2.4	MNLCS_FACILITY_IND.....	60
7.6.2.5	MNLCS_END_REQ.....	60
7.6.2.6	MNLCS_END_IND.....	60
8	Services assumed from signalling layers 1 and 2.....	60
8.1	Priority.....	60
8.2	Unacknowledged information transfer.....	60
8.3	Acknowledged information transfer.....	60
8.4	Random access.....	61
8.5	Channel management and measurements.....	61
9	Interlayer service interfaces on the MS side.....	61
9.1	Services provided by the Radio Resource Management entity.....	61
9.1.1	Service state diagram.....	62
9.1.2	Service primitives.....	63
9.1.2.1	RR_EST_REQ.....	63
9.1.2.2	RR_EST_IND.....	63
9.1.2.3	RR_EST_CNF.....	63
9.1.2.4	RR_REL_IND.....	63
9.1.2.5	RR_SYNC_IND.....	63
9.1.2.6	RR_DATA_REQ.....	63
9.1.2.7	RR_DATA_IND.....	64
9.1.2.8	RR_UNIT_DATA_IND.....	64
9.1.2.9	RR_ABORT_REQ.....	64
9.1.2.10	RR_ABORT_IND.....	64
9.1.3	Services provided by the Radio Resource Management entity for CTS.....	64
9.1.3.1	CTS_RR_ALIVE_CHECK_IND.....	64
9.2	Services provided by the Mobility Management entity.....	64
9.2.1	Service state diagram.....	65
9.2.2	Service primitives.....	66
9.2.2.1	MMXX_EST_REQ.....	66
9.2.2.2	MMXX_EST_IND.....	66
9.2.2.3	MMXX_EST_CNF.....	66
9.2.2.4	MMXX_REL_REQ.....	66
9.2.2.5	MMXX_REL_IND.....	66
9.2.2.6	MMXX_DATA_REQ.....	67
9.2.2.7	MMXX_DATA_IND.....	67
9.2.2.8	MMXX_UNIT_DATA_REQ.....	67
9.2.2.9	MMXX_UNIT_DATA_IND.....	67
9.2.2.10	MMCC_SYNC_IND.....	67
9.2.2.11	MMXX_REEST_REQ.....	67
9.2.2.12	MMXX_REEST_CNF.....	67
9.2.2.13	MMXX_ERR_IND.....	67
9.2.2.14	MMXX_PROMPT_IND.....	67
9.2.2.15	MMXX_PROMPT_REJ.....	67
9.3	Services provided by radio resource management entity for GPRS services.....	67
9.3.1	Service primitives for GRR-SAP.....	68
9.3.1.1	GRR-DATA-REQ.....	68
9.3.1.2	GRR-DATA-IND.....	68
9.3.1.3	GRR-UNITDATA-REQ.....	68
9.3.1.4	GRR-UNITDATA-IND.....	68
9.3.1.5	GRR-STATUS-IND.....	68
9.3.2	Service primitives for GMMRR-SAP.....	68
9.3.2.1	GMMRR-ASSIGN-REQ.....	68
9.3.2.2	GMMRR-PAGE-IND.....	68
9.4	Services provided by the LLC entity for GPRS services.....	69
9.4.1	Service primitives for LLGMM-SAP.....	69
9.4.1.1	LLGMM-ASSIGN-REQ.....	69
9.4.1.2	LLGMM-TRIGGER-REQ.....	69

9.4.1.3	LLGMM-TRIGGER-IND .....	69
9.4.1.4	LLGMM-SUSPEND-REQ .....	69
9.4.1.5	LLGMM-RESUME-REQ .....	69
9.4.1.6	LLGMM-WINDOW-REQ .....	69
9.4.1.7	LLGMM-WINDOW-CNF .....	70
9.4.1.8	LL-UNITDATA-REQ .....	70
9.4.1.9	LL-UNITDATA-IND .....	70
9.4.1.10	LLGMM-STATUS-IND .....	70
9.4.2	Service primitives for LLSMS-SAP .....	70
9.4.2.1	LL-UNITDATA-REQ .....	70
9.4.2.2	LL-UNITDATA-IND .....	70
9.5	Registration Services provided for GPRS Services .....	70
9.5.1	Service primitives for GMMSM-SAP .....	70
9.5.1.1	GMMSM-ESTABLISH-REQ .....	71
9.5.1.2	GMMSM-ESTABLISH-CNF .....	71
9.5.1.3	GMMSM-ESTABLISH-REJ .....	71
9.5.1.4	GMMSM-RELEASE-IND .....	71
9.5.1.5	GMMSM-UNITDATA-REQ .....	71
9.5.1.6	GMMSM-UNITDATA-IND .....	71
9.5.2	Service primitives for GMMAA-SAP .....	71
9.5.2.1	GMMAA-ESTABLISH-REQ .....	72
9.5.2.2	GMMAA-RELEASE-IND .....	72
9.5.2.3	GMMAA-ESTABLISH-REJ .....	72
9.5.3	Service primitives for GMMSMS-SAP .....	72
9.5.3.1	GMMSMS-REG-STATE-REQ .....	72
9.5.3.2	GMMSM-REG-STATE-RSP .....	72
10	Interlayer service interfaces on the Network side .....	73
10.1	Services provided by the Radio Resource Management entity .....	73
10.1.1	Service state diagram .....	73
10.1.2	Service primitives .....	74
10.1.2.1	RR_EST_REQ .....	74
10.1.2.2	RR_EST_IND .....	75
10.1.2.3	RR_EST_CNF .....	75
10.1.2.4	RR_REL_REQ .....	75
10.1.2.5	RR_REL_IND .....	75
10.1.2.6	RR_SYNC_REQ .....	75
10.1.2.7	RR_SYNC_CNF .....	75
10.1.2.8	RR_DATA_REQ .....	75
10.1.2.9	RR_DATA_IND .....	75
10.1.2.10	RR_UNIT_DATA_REQ .....	75
10.1.2.11	RR_UNIT_DATA_IND .....	75
10.1.2.12	RR_ABORT_REQ .....	75
10.1.2.13	RR_ABORT_IND .....	75
10.2	Services provided by the Mobility Management entity .....	75
10.2.1	Service state diagram .....	76
10.2.2	Service primitives .....	77
10.2.2.1	MMXX_EST_REQ .....	77
10.2.2.2	MMXX_EST_IND .....	77
10.2.2.3	MMXX_EST_CNF .....	77
10.2.2.4	MMXX_REL_REQ .....	77
10.2.2.5	MMXX_REL_IND .....	77
10.2.2.6	MMXX_DATA_REQ .....	77
10.2.2.7	MMXX_DATA_IND .....	77
10.2.2.8	MMXX_UNIT_DATA_REQ .....	77
10.2.2.9	MMXX_UNIT_DATA_IND .....	78
10.2.2.10	MMCC_SYNC_REQ .....	78
10.2.2.11	MMCC_SYNC_CNF .....	78
10.3	Services provided by radio resource management entity for GPRS services .....	78



10.3.1	Service primitives for GRR-SAP .....	78
10.3.1.1	GRR-DATA-REQ.....	78
10.3.1.2	GRR-DATA-IND .....	78
10.3.1.3	GRR-UNITDATA-REQ.....	78
10.3.1.4	GRR-UNITDATA-IND .....	78
10.3.1.5	GRR-STATUS-IND .....	78
10.3.2	Service primitives for GMMRR-SAP .....	79
10.3.2.1	GMMRR-PAGE-REQ.....	79
10.4	Services provided by the LLC entity for GPRS services .....	79
10.4.1	Service primitives for LLGMM-SAP .....	79
10.4.1.1	LLGMM-ASSIGN-REQ.....	79
10.4.1.2	LLGMM-TRIGGER-IND .....	79
10.4.1.3	LLGMM-SUSPEND-REQ .....	80
10.4.1.4	LLGMM-RESUME-REQ.....	80
10.4.1.5	LLGMM-WINDOW-REQ.....	80
10.4.1.6	LLGMM-WINDOW-CNF.....	80
10.4.1.7	LLGMM-PAGE-IND.....	80
10.4.1.8	LLGMM-PAGE-RESP-IND.....	80
10.4.1.9	LL-UNITDATA-REQ.....	80
10.4.1.10	LL-UNITDATA-IND.....	80
10.4.1.11	LLGMM-STATUS-IND.....	80
10.4.2	Service primitives for LLSMS-SAP .....	80
10.4.2.1	LL-UNITDATA-REQ.....	80
10.4.2.2	LL-UNITDATA-IND.....	80
10.5	Services provided by the GMM for GPRS services .....	81
10.5.1	Service primitives for GMMSM-SAP .....	81
10.5.1.1	GMMSM-RELEASE-IND.....	81
10.5.1.2	GMMSM-UNITDATA-REQ.....	81
10.5.1.3	GMMSM-UNITDATA-IND .....	81
10.6	Services provided by the Radio Resource Management entity for CTS on the fixed part .....	81
10.6.1	Service primitives.....	81
10.6.1.1	RR_CTS_ALIVE_CHECK_REQ.....	82
10.6.1.2	RR_CTS_ALIVE_CHECK_IND .....	82
10.6.1.3	RR_CTS_HUNTING_REQ.....	82
10.6.1.4	RR_CTS_GROUP_ALERTING_REQ .....	82
11	L3 Messages .....	82
11.1	General.....	82
11.1.1	Messages.....	82
11.1.2	Octets .....	83
11.1.3	Integer.....	83
11.1.3.1	Binary .....	83
11.1.3.2	2-complement binary.....	83
11.1.4	Spare parts .....	84
11.2	Standard L3 messages.....	84
11.2.1	Components of a standard L3 message .....	84
11.2.1.1	Format of standard information elements .....	84
11.2.1.1.1	Information element type and value part .....	84
11.2.1.1.2	Length indicator .....	85
11.2.1.1.3	Information element identifier.....	85
11.2.1.1.4	Categories of IEs; order of occurrence of IEI, LI, and value part.....	85
11.2.2	Description methods for IE structure .....	87
11.2.2.1	Tables.....	87
11.2.2.1.1	Compact notation .....	87
11.2.3	Imperative part of a standard L3 message .....	87
11.2.3.1	Header.....	88
11.2.3.1.1	Protocol discriminator.....	88
11.2.3.1.2	Skip indicator .....	88
11.2.3.1.3	Transaction identifier.....	88

11.2.3.1.4	Sub-protocol discriminator .....	89
11.2.3.2	Message type octet .....	90
11.2.3.3	Standard information elements of the imperative part .....	91
11.2.4	Non-imperative part of a standard L3 message .....	91
11.2.5	Presence requirements of information elements .....	91
11.2.6	Description of standard L3 messages .....	92
11.3	Non standard L3 messages .....	92
11.3.1	Case A : BCCCH and AGCH/PCH messages .....	93
11.3.1.1	L2 Pseudo Length octet .....	93
11.3.1.2	Rest Octets .....	93
11.3.1.3	Description of a modified standard L3 message .....	93
11.3.2	Case B : SACCH messages sent in unacknowledged mode .....	93
11.3.2.1	The first octet .....	94
11.3.2.2	The rest of the message .....	94
11.3.3	Design guidelines for non standard parts .....	94
11.3.3.1	General .....	94
11.4	Handling of superfluous information .....	94
11.4.1	Information elements that are unnecessary in a message .....	95
11.4.2	Other syntactic errors .....	95
<b>Annex A (informative): MN-Services arrow diagram.....</b>		<b>96</b>
<b>Annex B (informative): Description of CSN.1 .....</b>		<b>103</b>
B.1	The Basic Rules .....	103
B.1.1	Core Rules .....	103
B.1.1.1	Rule B1 : Bits .....	103
B.1.1.2	Rule B2 : Null String .....	103
B.1.1.3	Rule B3 : Concatenation .....	104
B.1.1.4	Rule B4 : Choice .....	104
B.1.1.5	Rule B5 : Naming .....	105
B.1.1.6	Rule B6 : Definition .....	105
B.1.2	Spare parts .....	105
B.1.2.1	Rule B7 : Spare bits .....	106
B.1.2.2	Rule B8 : Padding bits .....	106
B.1.3	Predefined sets .....	106
B.1.4	Labelling Parts .....	107
B.1.4.1	Rule A1 : Labels .....	107
B.1.5	Goodies .....	107
B.1.5.1	Rule G1 : Comments .....	107
B.2	Advanced rules .....	107
B.2.1	Rule A2 : Exponent notation .....	107
<b>Annex C (informative): GPRS-Services sequence diagram .....</b>		<b>109</b>
<b>Annex D (informative): Change Request History .....</b>		<b>127</b>
History .....		128

---

## Intellectual Property Rights

IPRs essential or potentially essential to the present document may have been declared to ETSI. The information pertaining to these essential IPRs, if any, is publicly available for **ETSI members and non-members**, and can be found in SR 000 314: "*Intellectual Property Rights (IPRs); Essential, or potentially Essential, IPRs notified to ETSI in respect of ETSI standards*", which is available from the ETSI Secretariat. Latest updates are available on the ETSI Web server (<http://www.etsi.org/ipr>).

Pursuant to the ETSI IPR Policy, no investigation, including IPR searches, has been carried out by ETSI. No guarantee can be given as to the existence of other IPRs not referenced in SR 000 314 (or the updates on the ETSI Web server) which are, or may be, or may become, essential to the present document.

---

## Foreword

This Technical Specification (TS) has been produced by the Special Mobile Group (SMG).

The present document defines the architecture of layer 3 and its sublayers on the GSM Um interface, i.e. the interface between Mobile Station and network within the digital cellular telecommunications system (Phase 2+).

The contents of the present document are subject to continuing work within SMG and may change following formal SMG approval. Should SMG modify the contents of the present document it will then be re-released with an identifying change of release date and an increase in version number as follows:

Version 7.x.y

where:

- 7 indicates Release 1998 of GSM Phase 2+
- x the second digit is incremented for all changes of substance, i.e. technical enhancements, corrections, updates, etc.
- y the third digit is incremented when editorial only changes have been incorporated in the specification.

---

# 1 Scope

This Technical Specification (TS) defines the principal architecture of layer 3 and its sublayers on the GSM Um interface, i.e. the interface between Mobile Station (MS) and network; for the CM sublayer, the description is restricted to paradigmatic examples, call control, supplementary services, and short message services for non-GPRS services. It also defines the basic message format and error handling applied by the layer 3 protocols.

For CTS services, this Technical Specification (TS) defines the principal architecture of layer 3 on the GSM Um\* interface, i.e. the interface between a CTS capable Mobile Station (CTS-MS) and a Fixed Part (FP).

The corresponding protocols are defined in other Technical Specifications, see subclause 4.3.4.

For non-GPRS services the communication between sublayers and adjacent layers and the services provided by the sublayers are distributed by use of abstract service primitives. But only externally observable behaviour resulting from the description is normatively prescribed by this Technical Specification.

For GPRS services in addition the local information transfer and stimuli sent between sublayers is informatively included within Annex C of in this Technical Specification.

---

# 2 References

The following documents contain provisions which, through reference in this text, constitute provisions of the present document.

- References are either specific (identified by date of publication, edition number, version number, etc.) or non-specific.
- For a specific reference, subsequent revisions do not apply.
- For a non-specific reference, the latest version applies.
- A non-specific reference to an ETS shall also be taken to refer to later versions published as an EN with the same number.
- For this Release 1998 document, references to GSM documents are for Release 1998 versions (version 7.x.y).

- [1] GSM 01.04: "Digital cellular telecommunications system (Phase 2+); Abbreviations and acronyms".
- [2] GSM 03.01: "Digital cellular telecommunications system (Phase 2+); Network functions".
- [3a] GSM 03.60: "Digital cellular telecommunications system (Phase 2+); General Packet Radio Service (GPRS) Description; Stage 2".
- [3b] GSM 03.56: "Digital cellular telecommunications system (Phase 2+); GSM Cordless Telephony System (CTS), phase 1; CTS Architecture Description; Stage 2".
- [3] GSM 04.01: "Digital cellular telecommunications system (Phase 2+); Mobile Station - Base Station System (MS - BSS) interface General aspects and principles".
- [3b] GSM 03.71: "Digital cellular telecommunications system (Phase 2+); Location Services (LCS) Functional Description; Stage 2".
- [4] GSM 04.05: "Digital cellular telecommunications system (Phase 2+); Data Link (DL) layer General aspects".
- [5] GSM 04.06: "Digital cellular telecommunications system (Phase 2+); Mobile Station - Base Station System (MS - BSS) interface Data Link (DL) layer specification".
- [6] GSM 04.08: "Digital cellular telecommunications system (Phase 2+); Mobile radio interface layer 3 specification".

- [7] GSM 04.10: "Digital cellular telecommunications system (Phase 2+); Mobile radio interface layer 3 Supplementary services specification General aspects".
- [8a] GSM 04.71: "Digital cellular telecommunications system (Phase 2+); Mobile radio interface layer 3 specification; Location Services (LCS)".
- [8] GSM 04.11: "Digital cellular telecommunications system (Phase 2+); Point-to-Point (PP) Short Message Service (SMS) support on mobile radio interface".
- [9] GSM 04.80: "Digital cellular telecommunications system (Phase 2+); Mobile radio interface layer 3 supplementary services specification Formats and coding".
- [10] GSM 04.81: "Digital cellular telecommunications system (Phase 2+); Line identification supplementary services - Stage 3".
- [10a] GSM 04.60: "Digital cellular telecommunications system (Phase 2+); General Packet Radio Services (GPRS); Mobile Station (MS) - Base Station System (BSS) interface; Radio Link Control and medium Access Control (RLS/MAC) layer specification"
- [10b] GSM 04.56: "Digital cellular telecommunications system (Phase 2+); GSM Cordless Telephony System (CTS), phase 1; CTS Radio Interface Layer 3 specification"
- [11] GSM 04.82: "Digital cellular telecommunications system (Phase 2+); Call Forwarding (CF) supplementary services - Stage 3".
- [11a] GSM 04.64 ; "Digital cellular telecommunications system (Phase 2+); Mobile Station - GPRS support node (MS-SGSN) Logical Link Control Layer Specification".
- [12] GSM 04.83: "Digital cellular telecommunications system (Phase 2+); Call Waiting (CW) and Call Hold (HOLD) supplementary services - Stage 3".
- [12a] GSM 04.65: "Digital cellular telecommunications system (Phase 2+); General Packet Radio Service (GPRS); Mobile Station (MS) - Serving GPRS Support Node (SGSN); Subnetwork Dependent Convergence Protocol (SNDCCP)".
- [13] GSM 04.84: "Digital cellular telecommunications system (Phase 2+); MultiParty (MPTY) supplementary services - Stage 3".
- [14] GSM 04.85: "Digital cellular telecommunications system (Phase 2+); Closed User Group (CUG) supplementary services - Stage 3".
- [15] GSM 04.86: "Digital cellular telecommunications system (Phase 2+); Advice of Charge (AoC) supplementary services - Stage 3".
- [16] GSM 04.88: "Digital cellular telecommunications system (Phase 2+); Call Barring (CB) supplementary services - Stage 3".
- [17] GSM 04.90: "Digital cellular telecommunications system (Phase 2+); Unstructured supplementary services operation - Stage 3".
- [18] CCITT Recommendation X.200: "Reference Model of Open systems interconnection for CCITT Applications".

---

## 3 Abbreviations

Abbreviations used in the present document, are listed in GSM 01.04.

For the purposes of the present document, the following abbreviations applies:

GMM	GPRS Mobility Management
MNS	Mobile Network Signalling
N-PDU	Network Protocol Data Unit
SM	Session Management
UDT	User Data Transfer
CTS	Cordless Telephony System
LCS	Location Services

---

## 4 Introduction

### 4.1 General

Three models are defined for Layer 3, one model for non-GPRS services, one for GPRS services supporting Class C MSs only and one model for GPRS-services supporting Class A and Class B MSs. (The third model is a combination of the first two models listed).

The layer 3 for non-GPRS services provides the functions necessary

- for Radio Resource (RR) management;
- for Mobility Management (MM); and
- for the Connection Management (CM) functions, i.e. functions for the control, provision, and support of services offered by the network; among which there are, e.g.:
  - the functions to establish, maintain and terminate circuit-switched connections across a GSM PLMN and other networks to which the GSM PLMN is connected;
  - supporting functions for supplementary services control;
  - supporting functions for short messages service control.
  - supporting functions for location services control.

The layer 3 for non-GPRS services is composed of three sublayers comprising:

- the Radio Resource Management (RR) functions;
- the Mobility Management (MM) functions; and
- the Connection Management (CM) functions.

When CTS services are added to non-GPRS services, the following functions are added:

- CTS Radio Resource Management (CTS-RR) functions to RR; and
- CTS Mobility Management (CTS-MM) functions to MM.

The layer 3 for GPRS services is composed of four sublayers comprising :

- the Radio Resource Management (RR) functions;
- the Mobility Management (GMM and GMM-AA);
- for the Logical Link Control (LLC);

- the Connection Management (CM) functions.
- Session Management (SM) functions to activate, modify and delete the contexts for packet data protocols (PDP)
- supporting functions for short messages service control.

The Connection Management (CM) sublayer is composed of functional blocks for:

- Call Control (CC) for non-GPRS services;
- Short Message Service Support (SMS) for non-GPRS services;
- GPRS Short Message Service Support (GSMS) (for GPRS services supporting Class A, B and C MSs);
- Session Management (SM) (for GPRS services supporting Class A, B and C MSs);
- Supplementary Services Support (SS) for non-GPRS services;
- Group Call Control for non-GPRS services;
- Broadcast Call Control (BCC) for non-GPRS services;
- Connection Management of Packet Data on Signalling channels for non-GPRS services.
- Location Services support (LCS) for non-GPRS services;

Within the context of LCS, for GSM LCS, the services defined for an MS are equally applicable to a type A LMU, unless otherwise stated. The following is a list of services essential for a type A LMU.

The layer 3 for non-GPRS services provides the functions necessary

- for Radio Resource (RR) management;
- for Mobility Management (MM); and
- supporting functions for location service control.

The layer 3 for non-GPRS services is composed of three sublayers comprising:

- the Radio Resource Management (RR) functions;
- the Mobility Management (MM) functions; and
- the Connection Management (CM) functions.

The Connection Management (CM) sublayer is composed of functional block for:

- location services support (LCS) for non-GPRS services.

This Technical Specification does not consider the distribution of signalling functions among the different network equipments. The signalling functions are described between two systems which represent the MS side and the network side of the radio interface of layer 3. Only the functions in the network for signalling communication with one MS is considered.

For GPRS services, in addition to the signalling functions also the user data transfer is included in this Technical Specification.

## 4.2 Applicability of functional blocks

Not for all functional blocks listed in subclause 4.1, support in the MS or in the network is mandatory:

- Support of Group Call Control is optional in the MS and in the network.
- Support of Broadcast Call Control is optional in the MS and in the network.
- Connection Management of Packet Data on Signalling channels. is optional in the MS and in the network.
- Support of GPRS services is optional in the MS and in the network.
- Support of CTS services is optional in the MS. CTS services are not applicable to the network.
- Support of LCS services is optional in the MS and in the network, but not optional in a type A LMU.

Further conditions and constraints are defined in other Technical Specifications.

## 4.3 Technique of description

Layer 3 and its sub-layers are specified by:

- their service specification, see subclause 4.3.1;
- their protocol specification, see subclause 4.3.3;
- the specification of functions, see clause 5.

### 4.3.1 Service description

The services of signalling layer 3 and its sublayers are described in terms of:

- services provided to upper (sub-)layers at the service access points;
- services assumed from lower (sub-)layers at the service access points;

Layer 3 and its supporting lower layers provide the Mobile Network Signalling (MNS) Service and User Data Transfer (UDT) Service (for GPRS services only) to the upper layers.

The service provided/assumed at the service access points are described by means of abstract service primitives and parameters as recommended in CCITT Recommendation X.200.

### 4.3.2 Abstract service primitives

The abstract service primitives consist of requests, responses, indications and confirmations. The general syntax of a primitive is specified in GSM 04.01.

### 4.3.3 Protocols and peer-to-peer communication

By use of the services provided by lower (sub-)layers, peer entities in a (sub-)layer in the MS and the network exchange information. Exchange of information between two peer entities is performed according to the corresponding (sub-)layer protocols. A protocol is a set of rules and formats by which the information (control information and user data) is exchanged between the two peers. The information is exchanged by use of messages which are defined in the protocol. (Therefore, the messages are also called Protocol Data Units, PDUs).

There are several protocols of the RR sublayer, one protocol of the LLC sublayer, three protocols of the MM sublayer, and several protocols of the CM sublayer. For each functional block of the CM sublayer as defined in subclause 4.1 there is one protocol. The CM protocols are specified in the Technical Specifications identified in subclause 4.3.4.



In the model used in this ETS, there is:

1) for non-GPRS services:

- one RR sub-layer entity in the MS and one RR sub-layer entity in the network;
- one MM sub-layer entity in the MS and one MM sub-layer entity in the network;

for each functional block of the CM sublayer as defined in subclause 4.1 which is supported in the MS (in the network), there are, depending on the protocol, one or more entities in the MS (in the network). Two different entities of the same functional block in the MS (in the network) are called parallel entities. The entities of the same functional block in the MS correspond in a one-to-one relation to the entities of the functional block in the network. The corresponding entities are called peer entities.

2) for CTS services (in addition to non-GPRS services)

- one RR sub-layer entity in the MS and one in the CTS fixed part. These RR sub-layers include one CTS-RR sub-entity on each side.
- one MM sub-layer entity in the MS and one in the CTS fixed part. These MM sub-layers include one CTS-MM sub-entity on each side.
- for each functional block of the CM sublayer as defined in subclause 4.1 which is supported in the MS (in the fixed part), there are, depending on the protocol, one or more entities in the MS (in the fixed part). Two different entities of the same functional block in the MS (in the fixed part) are called parallel entities. The entities of the same functional block in the MS correspond in a one-to-one relation to the entities of the functional block in the fixed part. The corresponding entities are called peer entities.

3) for GPRS services supporting Class C MSs :

- one RR sublayer entity (RR) in the MS and one RR sublayer entity in the network;
- six LLC sublayer entities (QoS1-QoS4, signalling, SMS) in the MS and six LLC sublayer entities in the network;
- one or more MM sublayer entities (GMM and/or 1-n GMM-AA) in the MS and one MM sublayer entity in the network (GMM or GMM-AA, i.e. the network don't know if several MM sublayer entities belong to the same MS or not);
- one SM entity in the MS's CM sublayer and one SM sublayer entity in the network's CM sublayer;
- one or more GSMS functional blocks in the CM sublayer if supported.:

4) for non-GPRS and GPRS services supporting Class A and Class B MSs :

- two RR sublayer entities (RR) in the MS and two RR sublayer entities in the network;
- six LLC sublayer entities (QoS1-QoS4, signalling, SMS) in the MS and six LLC sublayer entities in the network;
- two or more MM sublayer entities (GMM + MM or 1-n GMM-AA + MM or GMM + 1-n GMM-AA + MM) in the MS and one or two MM sublayer entity in the network (GMM + MM or GMM-AA);
- one SM entity in the MS's CM sublayer and one SM entity in the network's CM sublayer;
- for each functional block of the CM sublayer as defined in subclause 4.1 which is supported in the MS (in the network), there are, depending on the protocol, one or more entities in the MS (in the network). Two different entities of the same functional block in the MS (in the network) are called parallel entities. The entities of the same functional block in the MS correspond in a one-to-one relation to the entities of the functional block in the network. The corresponding entities are called peer entities.

As each sub-layer entity is specified by one and only one protocol, it is also called a protocol entity or protocol control entity.

For GPRS-services supporting Class A and Class B MSs, the MM entities of the MM-sublayer are able to exchange information by means of GMM PDUs as well as MM PDU's. This means if a mobile is GPRS attached, non-GPRS mobility management procedures may make use of GPRS mobility management messages.

When two peer protocol entities exchange PDUs, a transaction is said to be established (or: to be active; or: to exist). It depends from the protocol when exactly a protocol entity considers the transaction to be active, normally this is the case.

- from the moment when it has passed the first suitable message to lower (sub-) layers or received the first suitable message from its peer entity.

up to the moment when it has released the transaction.

#### 4.3.4 Contents of layer 3 related Technical Specifications

The Radio Resource (RR) management protocol is defined in GSM 04.08:

- the Mobility Management (MM) protocol is defined in GSM 04.08;
- the Session Management (SM) protocol is defined in GSM 04.08;
- the Call Control (CC) protocol is defined in GSM 04.08;
- the Supplementary Services (SS) protocol is defined in GSM 04.10, GSM 04.8x and GSM 04.9x;
- the Short Message Service (SMS) protocol is defined in GSM 04.11;
- the Group Call Control (GCC) protocol is defined in GSM 04.68;
- the protocols for Packet Data on Signalling channels (PDS), PDSS1 and PDSS2, are defined in GSM 04.63;
- the Logical Link Control (LLC) protocol is defined in GSM 04.64;
- the GPRS Radio Resource (GRR) protocol is defined in GSM 04.60 and GSM 04.08.
- the CTS Radio Resource (CTS-RR) sub-protocol is defined in GSM 04.56;
- the CTS Mobility Management (CTS-MM) sub-protocol is defined in GSM 04.56;
- the CTS additions to the Call Control (CC) protocol are defined in GSM 04.56.
- the Location Services (LCS) protocol is defined in GSM 03.71 and GSM 04.71.

---

## 5 Structure of layer 3 functions

### 5.1 Basic groups of functions

Most functions of layer 3 and its sub-layers are described by the service specifications and protocol specifications of the (sub-)layers.

These functions are in the model realised by protocol control entities, see subclause 4.3.3.

In addition, routing functions are contained in layer 3 which are related to the transport of messages, e.g. multiplexing and splitting. These routing functions are defined in the Radio Resource Management and Mobility Management sub-layers.

- 1) They have the task to pass the messages from upper (sub-)layers to lower (sub-)layers.
- 2) They also have the task to pass messages provided by lower (sub-layers) to the appropriate sub-layer and, if applicable, entity.

The routing functions with task 2 make use of the protocol discriminator (PD) which is part of the message header.

A CM sublayer protocol may also define a transaction identifier (TI) as a part of the message header. This is at least the case if there are parallel entities of the same functional block, see subclause 4.3.3. If it is a part of a message, the TI is also used by the routing functions.

- The MM-sublayer routing function passes the messages of the CM entities as well as of the MM, GMM, GMM-AA and CTS-MM entities of its own sublayer to the service access point of RR, GRR, LLC or CTS-RR. Furthermore it multiplexes them in case of parallel transactions.
- The routing function of Radio Resource Management distributes the messages to be sent according to their message type and protocol discriminator (PD), to the actual channel configuration, and, if applicable, to further information received from upper sub-layers to the appropriate service access point of layer 2 (identified by SAPI and logical channel). Paging messages received from the PPCH are always routed to GMM, while paging messages received from the PCH are distributed to GMM or MM based on the temporary identifier (TMSI or TLL).
- The messages provided at the different service access points of layer 2 are distributed by the RR sublayer routing function according to their protocol discriminator (PD). Messages with a PD equal to RR are passed to the RR entity of the own sublayer, all other messages are passed to the MM sublayer at the service access point RR-SAP.
- The routing function of MM-sublayer passes Standard L3 messages according to the protocol discriminator (PD) and, if applicable, the transaction identifier (TI) or the PDP address towards the MM entity or towards the CM entities via the various MM-SAP's. GPRS L3 messages are routed to mobility management or session management according to the protocol discriminator.
- The routing function of LLC passes the messages according to the SAPIs to the MM sublayer or to the SNDPCP entities.

The message (message header or other parts of the message) are neither changed nor removed by the RR routing function or MM routing function before passing it to the appropriate service access point.

## 5.2 Protocol architecture

The protocol architecture is visualised for each of the three models:

- Figure 5.1/GSM 0407 shows the protocol architecture for a MS not supporting the GPRS service, restricting the representation of CM sublayer protocols to four paradigmatic examples, CC, LCS, SS, and SMS. Note that the protocol stack for a class C GPRS service may be present in the MS, but it is not active simultaneously.
- Figure 5.2 shows the protocol architecture for a MS supporting the Class C GPRS service. (Note that the protocol stack for a circuit switched services may be present in the MS, but it is not active simultaneously)
- Figure 5.3 shows the protocol architecture for non-GPRS and GPRS-services supporting Class A and Class B MSs
- Figure 5.4 shows the protocol architecture for a MS supporting CTS services in addition to non-GPRS services.

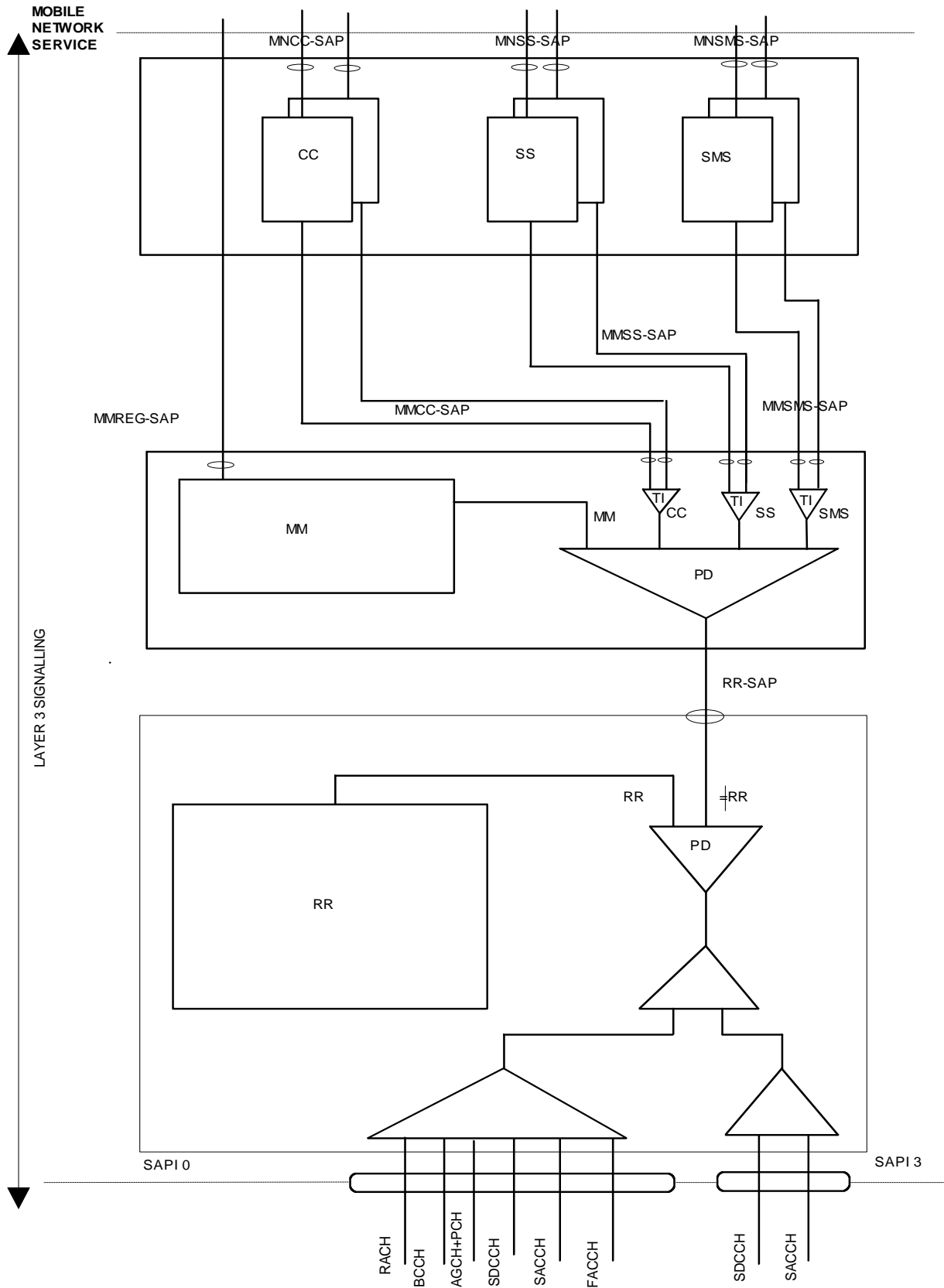


Figure 5.1: Protocol Architecture not supporting GPRS service- MS side

(Note: Figure 5.1 shall be updated to include the new PD for LCS in the same manner as the other PDs are shown)

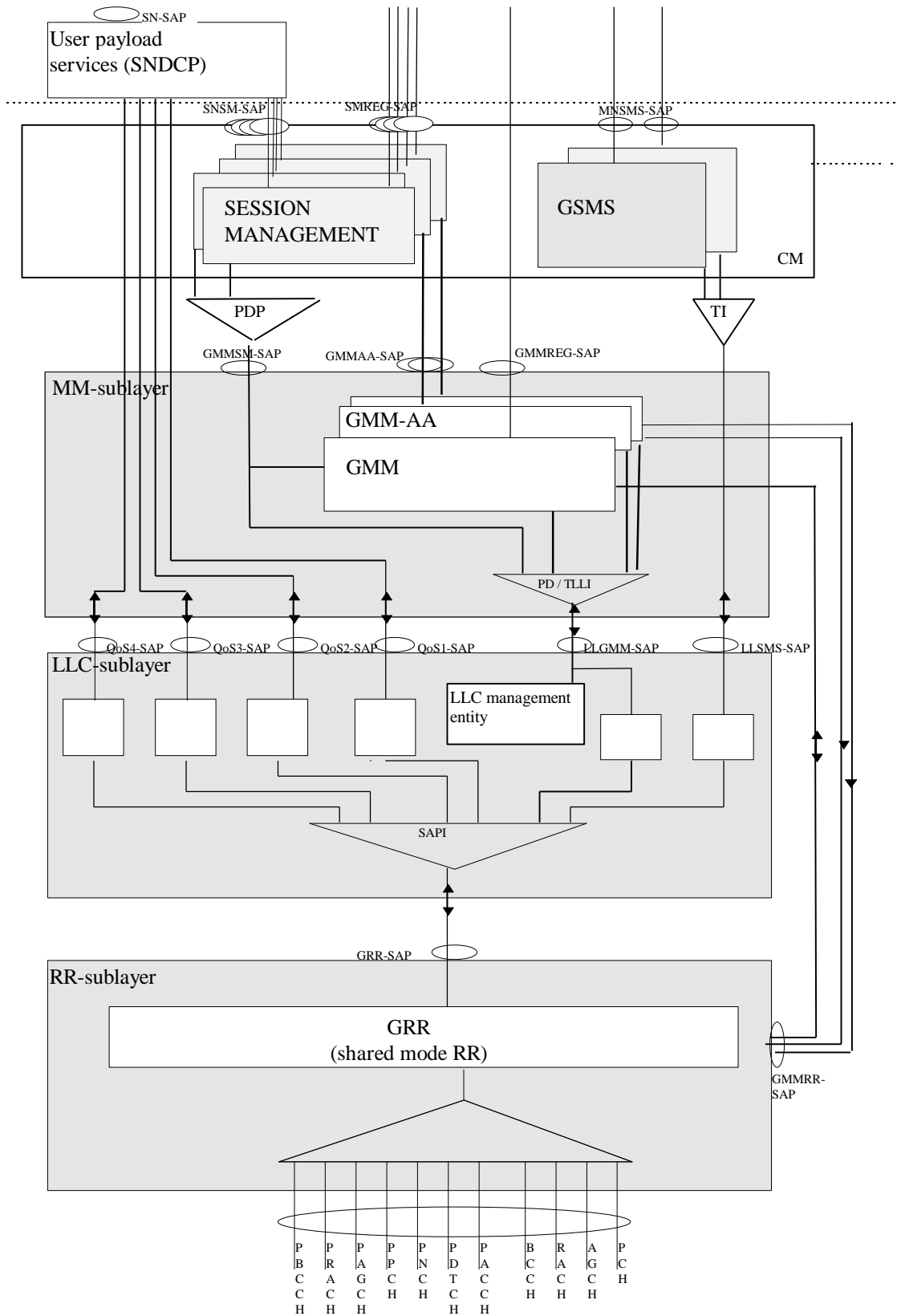


Figure 5.2, Protocol architecture supporting GPRS class C MSs, MS - side

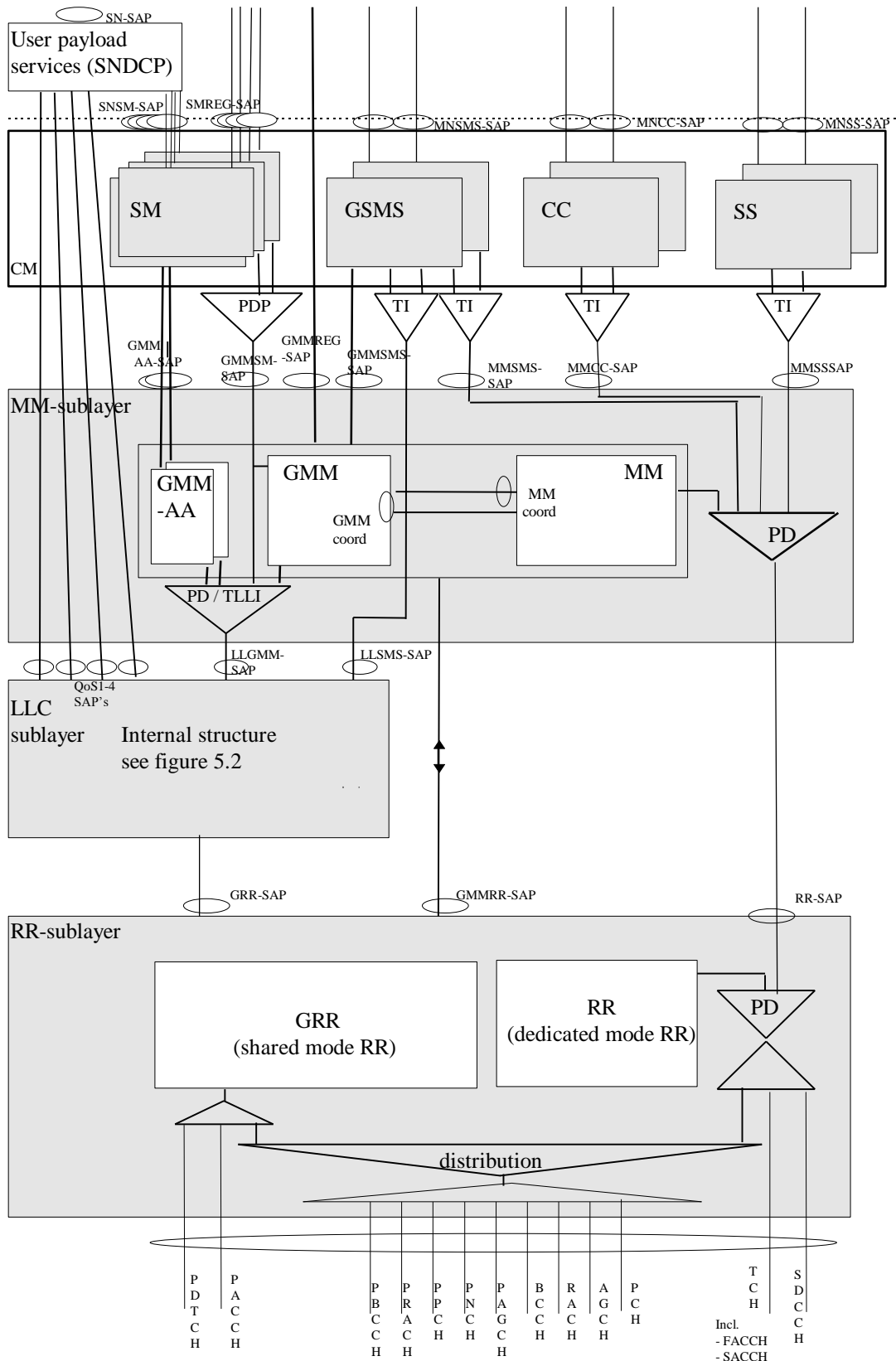


Figure 5.3/ GSM 04.07, Protocol architecture supporting GPRS class A and B MSs, MS - side

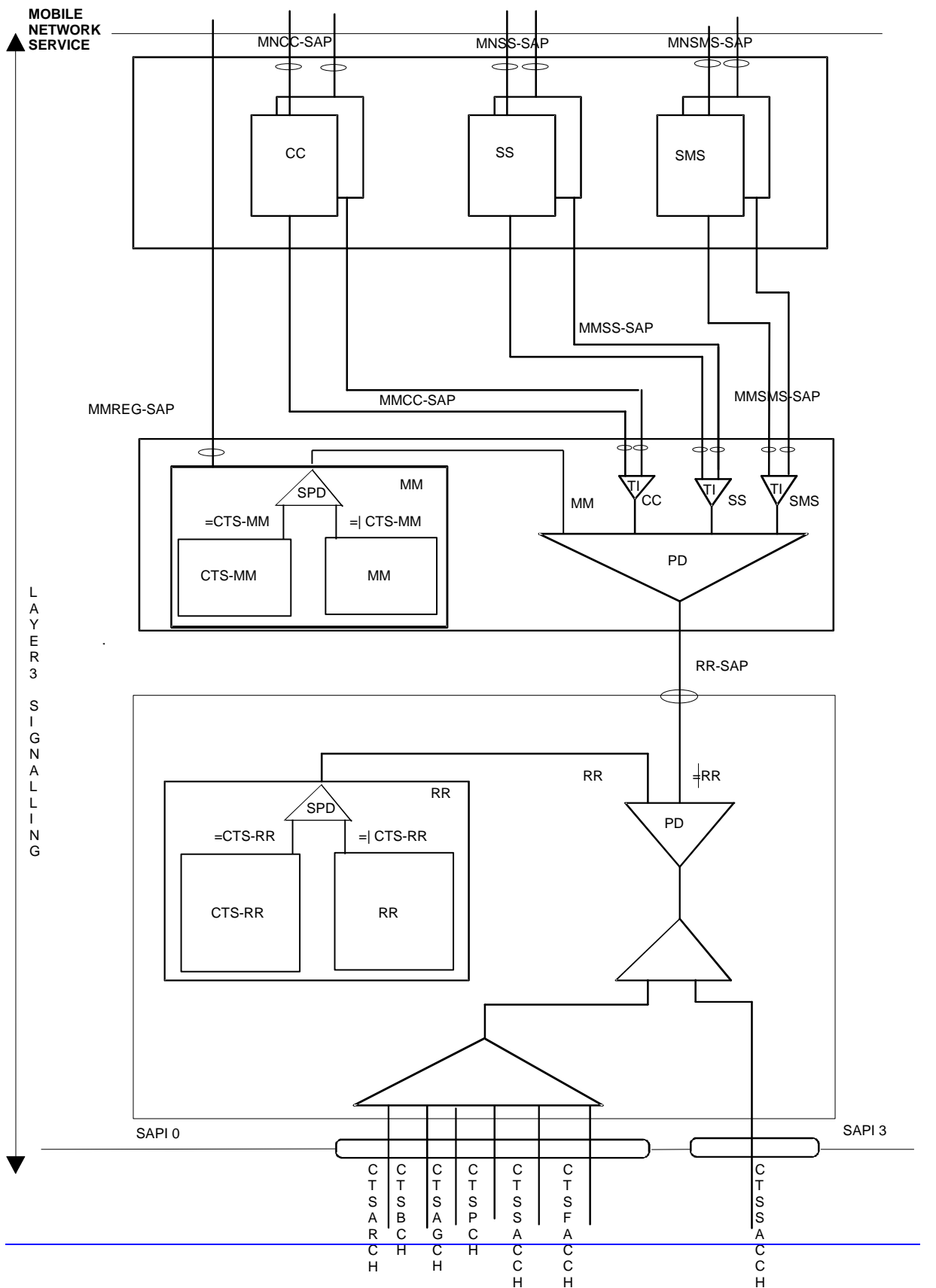


Figure 5.4/ GSM 04.07, Protocol architecture supporting CTS services in addition to non- GPRS services, MS - side

As shown in figure 5.1 a hierarchy of 3 sublayers is defined:

- the RR sublayer provides services to the MM sublayer and utilizes the services of signalling layer 2;
- the MM sublayer provides common services to the entities of the Connection Management (CM) sublayer;
- the CM sublayer includes, among others, the CC, SS, and SMS entities, which are independent entities.

Figure 5.2 defines four sublayers for GPRS services :

- the RR sublayer provides services to the MM and LLC sublayers;
- the LLC sublayer provides services to the MM sublayer, the SNDCP and GSMS entities and uses services of the RR sublayer;
- the MM sublayer provides services to the SM entities of the CM. The MM sublayer either includes (a.) one GMM entity for non-anonymous access or (b.) one or more GMM-AA entities for anonymous access or (c.) one GMM entity and one or more GMM-AA entities;
- the CM sublayer includes the SM and GSMS entities. The SM entity provides services to the SNDCP entity and uses services of the MM sublayer. The GSMS entity is identical to the SMS entity for non-GPRS services except it uses the services from the LLC sublayer

Figure 5.3 defines four sublayers for non-GPRS and GPRS-services supporting Class A and Class B MSs :

- the RR sublayer provides services to the MM and LLC sublayers;
- the LLC sublayer provides services to the MM sublayer, the SNDCP and GSMS entities and uses services of the RR sublayer;
- the MM sublayer provides services to the SNDCP entity and to the entities of the Connection Management (CM) sublayer. In addition to the MM entity for non-GPRS services, the MM sublayer further includes either (a.) one GMM entity for non-anonymous access or (b) one or more GMM-AA entities for anonymous access or (c.) one GMM entity and one or more GMM-AA entities;
- the CM sublayer includes, among others, the CC, SS, GSMS and SM entities, which are independent entities.

The SM entity provides services to the SNDCP entity and uses services of the MM sublayer.

The GSMS entity is an extension of the SMS entity for non-GPRS services. For message transfer it uses the services both from the LLC sublayer and the MM entity of the MM sublayer. Furthermore it retrieves from the MM entity information about which transport service to use.

Figure 5.4 defines three sub-layers for CTS services:

- the RR sublayer provides services (including CTS services) to the MM sublayer and uses the services of signalling layer 2;
- the MM sublayer provides common services to the entities of the Connection Management (CM) sublayer; it provides also specific CTS services to the entities above CM.
- the CM sublayer includes, among others, the CC, SS, and SMS entities, which are independent entities.



---

## 6 Services provided by signalling layer 3 at the MS side

The different classes of services provided by signalling layer 3 at the MS side are accessible at the following service access points:

- registration services at the MMREG-SAP or GMMREG-SAP;
- Call Control services for normal and emergency calls including call related Supplementary Services Support services at the MNCC-SAP;
- Short Message Services Support services at the MNSMS-SAP;
- Call independent Supplementary Services Support services at the MNSS-SAP;
- Location Services Support services at the MNLCS-SAP;
- other services corresponding to further functional blocks of the CM sublayer at the appropriate service access points. These services are not further described in this clause;
- Session Management services at the SMREG-SAP and at the SNSM-SAP
- Logical Link Control services at the QoS1-SAP, QoS2-SAP, QoS3-SAP and QoS4-SAP.

### 6.1 Registration services

The registration services (location updating, IMSI attach/detach) are provided at the service access point MMREG-SAP. As opposed to all other MN-Services, these services are provided by and can be directly accessed at the Mobility Management sublayer.

#### 6.1.1 Service state diagram for MS not supporting GPRS service

The registration services provided at the service access point MMREG-SAP are illustrated in the state of figure 6.1 below.

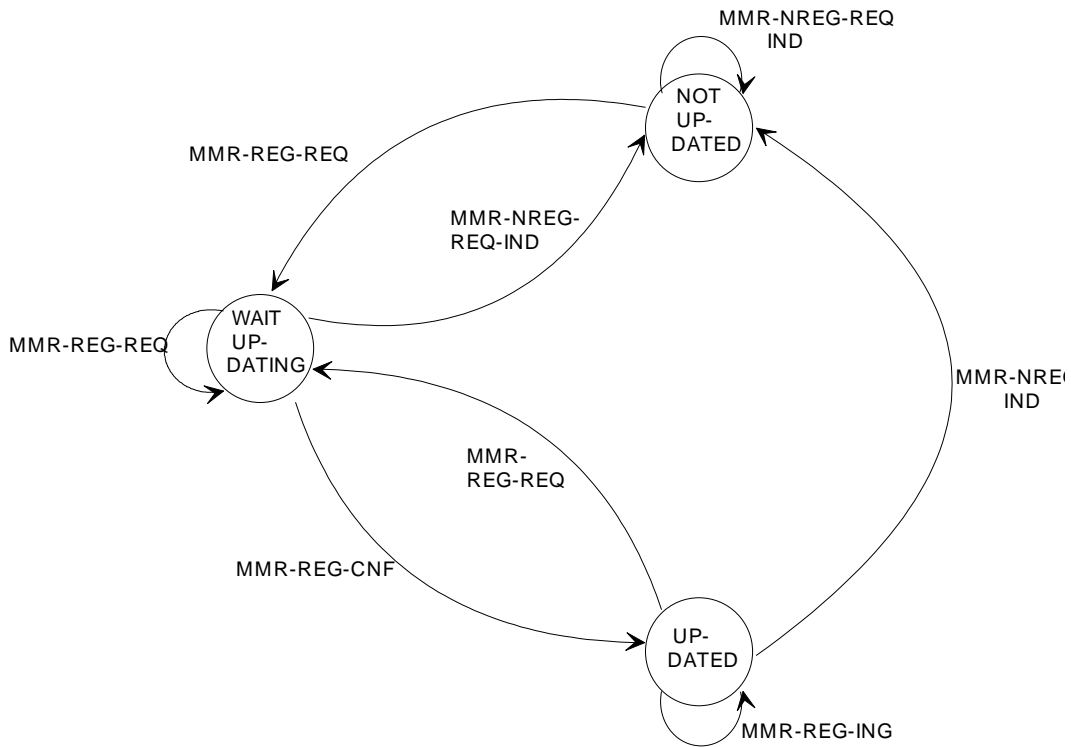


Figure 6.1: Registration services provided at MMREG-SAP - MS side

### 6.1.2 Service primitives

Table 6.1: Primitives and Parameters at the MMREG-SAP - MS side

PRIMITIVE	PARAMETER	REFERENCE
MMR_REG_REQ	IMSI	6.1.2.1
MMR_REG_CNF	-	6.1.2.2
MMR_NREG_REQ	-	6.1.2.4
MMR_NREG_IND	cause	6.1.2.5

#### 6.1.2.1 MMR\_REG\_REQ

Registration request, triggered by activation of the IMSI, e.g., by activation of the MS with inserted SIM, insertion of the SIM into the activated MS, pressing of a reset button.

#### 6.1.2.2 MMR\_REG\_CNF

Registration confirmation. Indicates to the user that the MS is ready to start a transaction.

#### 6.1.2.3 [reserved]

#### 6.1.2.4 MMR\_NREG\_REQ

Request to cancel the registration, stimulated either by removing the SIM or automatically in the power off phase.

#### 6.1.2.5 MMR\_NREG\_IND

Indication that registration has been cancelled or that registration was not possible. Only emergency services are available to the user.

### 6.1.3 Registration Services for CTS-Services

The registration services (attach/detach, enrolment/de-enrolment) are provided for CTS services at the service access point MMREG-SAP.

**Table 6.1.3: Primitives and Parameters at the MMREG-SAP - MS side for CTS**

PRIMITIVE	PARAMETER	REFERENCE
MMR_CTS_ATTACH_REQ	IMSI	6.1.3.1
MMR_CTS_ATTACH_CNF	-	6.1.3.2
MMR_CTS_ATTACH_REJ	IFPSI, cause	6.1.3.3
MMR_CTS_DETACH_IND	-	6.1.3.4
MMR_CTS_ENROLL_REQ	IMSI	6.1.3.5
MMR_CTS_ENROLL_CNF	-	6.1.3.6
MMR_CTS_ENROLL_REJ	IFPSI, cause	6.1.3.7
MMR_CTS_DE_ENROLL_IND	-	6.1.3.8

#### 6.1.3.1 MMR\_CTS\_ATTACH\_REQ

MS initiates the CTS attach. CTS-MM is requested to send a CTS ATTACH REQUEST message to the fixed part.

#### 6.1.3.2 MMR\_CTS\_ATTACH\_CNF

The CTS attach was successful. The fixed part confirmed the attach, i.e. the CTS ATTACH ACCEPT message was received by the MS.

#### 6.1.3.3 MMR\_CTS\_ATTACH\_REJ

The CTS attach has failed. The fixed part rejected the attach attempt, i.e. the CTS ATTACH REJECT message was received by the MS.

#### 6.1.3.4 MMR\_CTS\_DETACH\_IND

MS initiates CTS detach. CTS-MM is requested to send a CTS DETACH INDICATION message. The detach procedure is initiated.

#### 6.1.3.5 MMR\_CTS\_ENROLL\_REQ

MS initiates the CTS enrolment. CTS-MM is requested to send a CTS ENROLMENT REQUEST message to the fixed part.

#### 6.1.3.6 MMR\_CTS\_ENROLL\_CNF

The CTS enrolment was successful. The fixed part confirmed the enrolment, i.e. the CTS ENROLMENT ACCEPT message was received by the MS.

#### 6.1.3.7 MMR\_CTS\_ENROLL\_REJ

The CTS enrolment has failed. The fixed part rejected the enrolment attempt, i.e. the CTS ENROLMENT REJECT message was received by the MS.

#### 6.1.3.8 MMR\_CTS\_DE\_ENROLL\_IND

FP initiates CTS de-enrolment. CTS-MM is requested to send a CTS DE-ENROLMENT INDICATION message. The de-enrolment procedure is initiated.

## 6.2 Call Control services

The Call Control services are provided by multiple CC entities at the service access point MNCC-SAP.

The Call Control service class consists of the following services:

- Mobile originated and Mobile terminated call establishment for normal calls;
- Mobile originated call establishment for emergency calls;
- call maintaining;
- call termination;
- call related Supplementary Services Support.

### 6.2.1 Service state diagram

The Call Control services provided at the service access point MNCC-SAP are illustrated in the state diagram of figure 6.2.

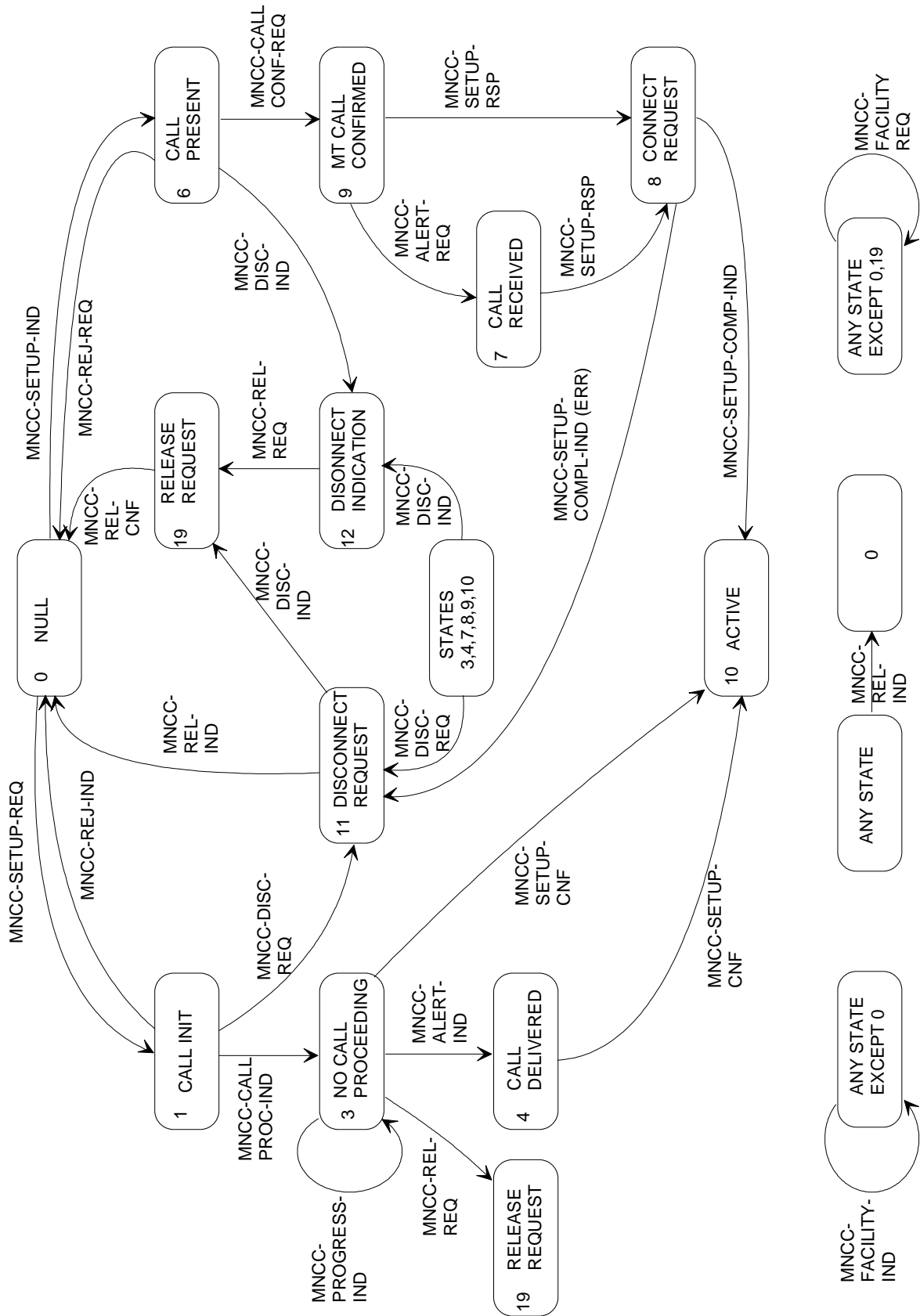


Figure 6.2: Service graph of Call Control entity - MS side (page 1 of 2)

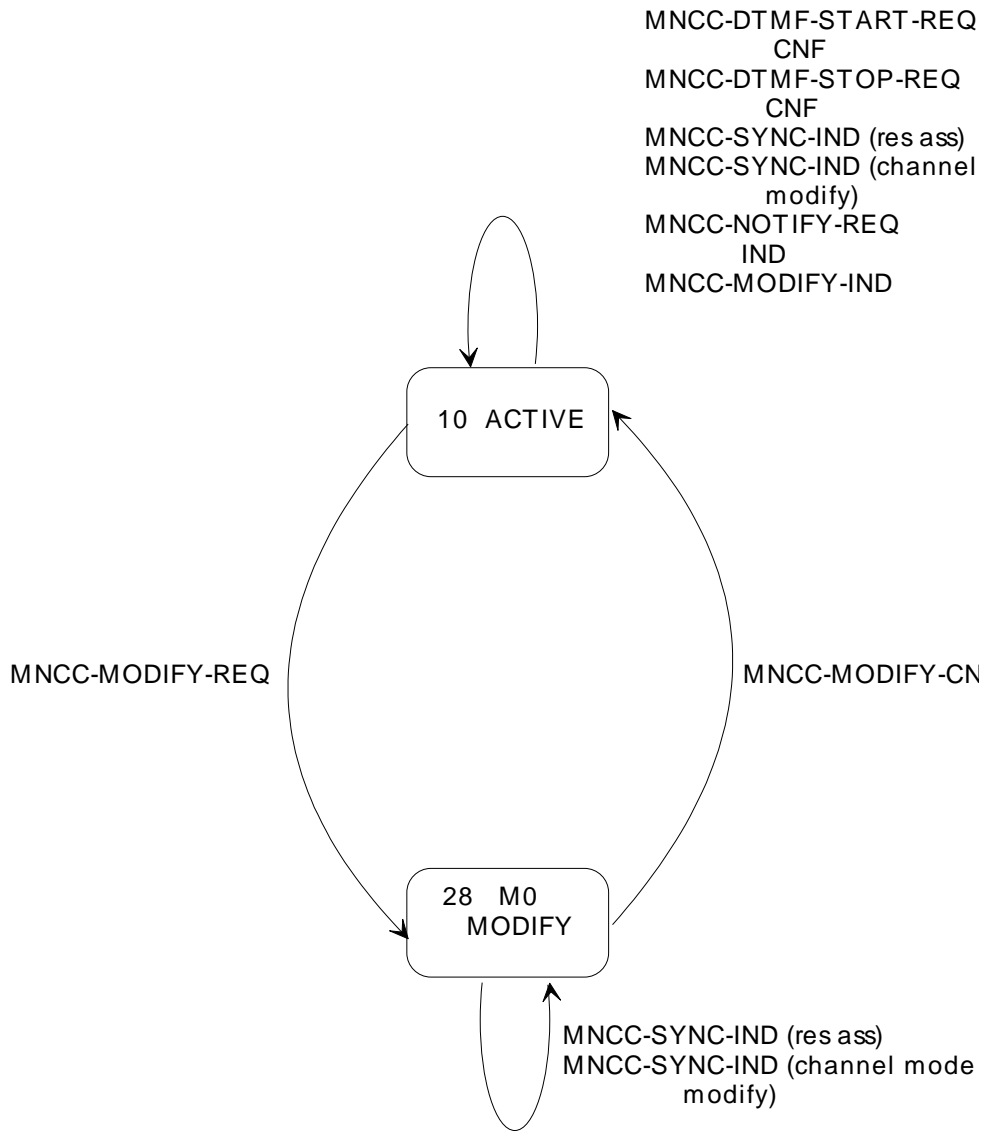


Figure 6.2: Service graph of Call Control entity - MS side Active state (page 2 of 2)

## 6.2.2 Service primitives

**Table 6.2: Primitives and parameters at MNCC-SAP - MS side**

PRIMITIVE	PARAMETER (message, info elements of message, other parameters)	REFERENCE
MNCC_SETUP_REQ	SETUP or EMERGENCY SETUP	6.2.2.1
MNCC_SETUP_IND	SETUP	6.2.2.2
MNCC_SETUP_RSP	CONNECT	6.2.2.3
MNCC_SETUP_CNF	CONNECT	6.2.2.4
MNCC_SETUP_COMPLETE_REQ	-	6.2.2.5
MNCC_SETUP_COMPLETE_IND	-	6.2.2.6
MNCC_REJ_REQ	RELEASE COMPLETE	6.2.2.7
MNCC_REJ_IND	cause	6.2.2.8
MNCC_CALL_CONF_REQ	CALL CONFIRMED	6.2.2.9
MNCC_CALL_PROC_IND	CALL PROCEEDING	6.2.2.10
MNCC_PROGRESS_IND	PROGRESS	6.2.2.11
MNCC_ALERT_REQ	ALERTING	6.2.2.12
MNCC_ALERT_IND	ALERTING	6.2.2.13
MNCC_NOTIFY_REQ	NOTIFY	6.2.2.14
MNCC_NOTIFY_IND	NOTIFY	6.2.2.15
MNCC_DISC_REQ	DISCONNECT	6.2.2.16
MNCC_DISC_IND	DISCONNECT	6.2.2.17
MNCC_REL_REQ	RELEASE	6.2.2.18
MNCC_REL_IND	RELEASE	6.2.2.19
MNCC_REL_CNF	RELEASE or RELEASE COMPLETE	6.2.2.20
MNCC_FACILITY_REQ	facility	6.2.2.21
MNCC_FACILITY_IND	facility	6.2.2.22
MNCC_START_DTMF_REQ	START DTMF	6.2.2.23
MNCC_START_DTMF_CNF	START DTMF ACK or START DTMF REJ	6.2.2.24
MNCC_STOP_DTMF_REQ	STOP DTMF	6.2.2.25
MNCC_STOP_DTMF_CNF	STOP DTMF ACK	6.2.2.26
MNCC_MODIFY_REQ	MODIFY	6.2.2.27
MNCC_MODIFY_IND	MODIFY	6.2.2.28
MNCC_MODIFY_RES	MODIFY COMPLETE	6.2.2.29
MNCC_MODIFY_CNF	MODIFY COMPLETE	6.2.2.30
MNCC_SYNC_IND	cause (res. ass., channel mode modify)	6.2.2.31

### 6.2.2.1 MNCC\_SETUP\_REQ

Request to send a SETUP or EMERGENCY SETUP message to initiate Mobile originating establishment of either a normal or an emergency call.

### 6.2.2.2 MNCC\_SETUP\_IND

Receipt of a SETUP message, the Mobile terminated call establishment has been initiated.

### 6.2.2.3 MNCC\_SETUP\_RES

Response to send a CONNECT message to indicate call acceptance by the Mobile terminated user; call control is requested to attach the user connection (if it is not yet attached).

### 6.2.2.4 MNCC\_SETUP\_CNF

Receipt of a CONNECT message, the Mobile originated call has been accepted by the remote called user.

### 6.2.2.5 MNCC\_SETUP\_COMPL\_REQ

Request to send a CONNECT ACKNOWLEDGE message, the mobile originating call has been accepted.

### 6.2.2.6 MNCC\_SETUP\_COMPL\_IND

Receipt of a CONNECT ACKNOWLEDGE message, the Mobile terminated call establishment has been completed; for a data call, the user is informed that the user connection is attached.

### 6.2.2.7 MNCC\_REJ\_REQ

Request to reject a Mobile terminated call if the call is refused or if the call cannot be accepted, e.g., because of missing compatibility.

### 6.2.2.8 MNCC\_REJ\_IND

Indication that the Mobile originated call has been rejected, e.g. if the MM connection cannot be provided or if the call establishment initiation has been rejected by the network.

### 6.2.2.9 MNCC\_CALL\_CONF\_REQ

Request to confirm a Mobile terminated call by sending a CALL CONFIRMED message. A bearer capability different from that given in MNCC\_SETUP\_IND may be offered to the remote calling user.

### 6.2.2.10 MNCC\_CALL\_PROC\_IND

Indication to the Mobile originating user that call establishment has been initiated in the Network and no more call establishment information will be accepted by the Network.

### 6.2.2.11 MNCC\_PROGRESS\_IND

Indication to the Mobile user that a PROGRESS message or a message containing a *progress* IE has been received, e.g., because the call is progressing in the PLMN/ISDN environment, or because the call has left the PLMN/ISDN environment, or because in-band tones/announcement are available.

### 6.2.2.12 MNCC\_ALERT\_REQ

Request to send an ALERTING message from the called Mobile user to the remote calling user to indicate that user alerting has been initiated.

### 6.2.2.13 MNCC\_ALERT\_IND

Indication of the receipt of an ALERTING message, alerting to the remote called user has been initiated.

### 6.2.2.14 MNCC\_NOTIFY\_REQ

Request to send information pertaining to a call, such as user suspended, to the Network by the Mobile user.



**6.2.2.15 MNCC\_NOTIFY\_IND**

Indication to the Mobile user that information pertaining to a call, such as remote user suspended, has been received from the Network.

**6.2.2.16 MNCC\_DISC\_REQ**

Request to send a DISCONNECT message to the Network in order to clear the end-to-end connection.

**6.2.2.17 MNCC\_DISC\_IND**

Indication of reception of a DISCONNECT message, by which the Network indicates that the end-to-end connection is cleared.

**6.2.2.18 MNCC\_REL\_REQ**

Request of the Mobile user to send a RELEASE message to inform the Network that the user intends to release the call reference and the corresponding MM connection so that the Network can release its MM connection and the correspondent call reference.

**6.2.2.19 MNCC\_REL\_IND**

Indication to the Mobile originating or terminated user that a RELEASE message has been received and the Network intends to release its MM connection. The Mobile user is requested to release the call reference and the corresponding MM connection.

**6.2.2.20 MNCC\_REL\_CNF**

Confirmation of the Mobile user's request to release the MM connection and call reference in the Network. The Mobile user may release the call reference and the corresponding MM connection.

**6.2.2.21 MNCC\_FACILITY\_REQ**

Request to transport a *facility* IE for a call related supplementary service invocation.

**6.2.2.22 MNCC\_FACILITY\_IND**

Indication that a *facility* IE for a call related supplementary service invocation has been received.

**6.2.2.23 MNCC\_START\_DTMF\_REQ**

Request to send a START DTMF message in order to start a DTMF control operation.

**6.2.2.24 MNCC\_START\_DTMF\_CNF**

Confirmation of the receipt of a START DTMF ACKNOWLEDGE or START DTMF REJECT message that the start of a DTMF control operation has been acknowledged or rejected.

**6.2.2.25 MNCC\_STOP\_DTMF\_REQ**

Request to send a STOP DTMF message in order to stop a DTMF control operation.

**6.2.2.26 MNCC\_STOP\_DTMF\_CNF**

Confirmation of the receipt of STOP DTMF ACKNOWLEDGE message, the DTMF control operation has been stopped.

### 6.2.2.27 MNCC\_MODIFY\_REQ

Request to start Mobile originating in-call modification by sending a MODIFY message.

### 6.2.2.28 MNCC\_MODIFY\_IND

RECEIPT OF A MODIFY message, a Mobile terminating in-call modification has been initiated.

### 6.2.2.29 MNCC\_MODIFY\_RES

Response to send a MODIFY COMPLETE message to indicate Mobile terminating in-call modification completion by the Mobile user.

### 6.2.2.30 MNCC\_MODIFY\_CNF

Receipt of a MODIFY COMPLETE message, the Mobile originating in-call modification has been completed.

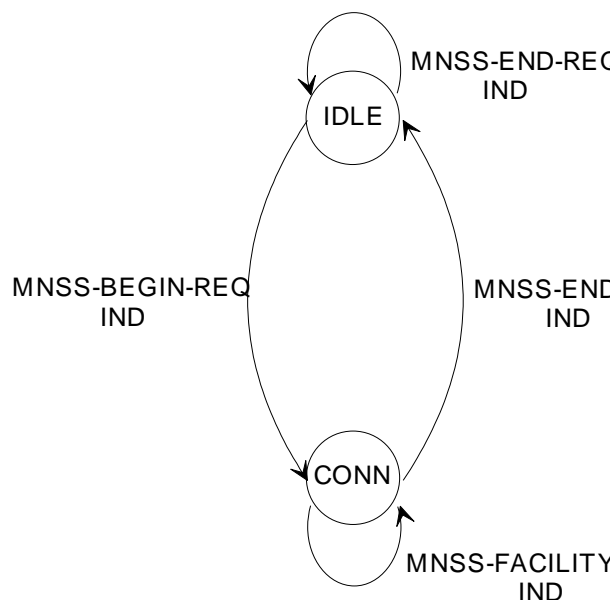
### 6.2.2.31 MNCC\_SYNC\_IND

Indication that a dedicated channel assignment has been performed (res. ass. = "resource assigned") and/or the channel mode has been changed.

## 6.3 Call independent Supplementary Services Support

### 6.3.1 Service state diagram

The primitives provided by the call independent Supplementary Services Support entity and the transitions between permitted states are shown in figure 6.3.



STATES:

IDLE - No SS signalling transaction pending

CONN - SS signalling transaction established

**Figure 6.3: Service graph of the call independent Supplementary Services Support entity - MS side**

## 6.3.2 Service primitives

**Table 6.3: Primitives and Parameters at MNSS-SAP - MS side**

PRIMITIVES	PARAMETERS (Info elements of message)	REFERENCE
MNSS_BEGIN_REQ	REGISTER	6.3.2.1
MNSS_BEGIN_IND	REGISTER	6.3.2.2
MNSS_FACILITY_REQ	FACILITY	6.3.2.3
MNSS_FACILITY_IND	FACILITY	6.3.2.4
MNSS_END_REQ	REL COMPLETE	6.3.2.5
MNSS_END_IND	REL COMPLETE	6.3.2.6

### 6.3.2.1 MNSS\_BEGIN\_REQ

Request to send a REGISTER message in order to establish a signalling transaction for the provision of call independent supplementary services. The request for a call independent supplementary service invocation may be included.

### 6.3.2.2 MNSS\_BEGIN\_IND

Receipt of a REGISTER message, a signalling transaction is established for the provision of call independent supplementary services after receipt of a REGISTER message. The indication of a supplementary service invocation may be included.

### 6.3.2.3 MNSS\_FACILITY\_REQ

Request to send a FACILITY message for the provision of a call independent supplementary service invocation.

### 6.3.2.4 MNSS\_FACILITY\_IND

Receipt of a FACILITY message for a call independent supplementary service invocation.

### 6.3.2.5 MNSS\_END\_REQ

Request to send a RELEASE COMPLETE message in order to release the signalling transaction. The request for transfer of a supplementary service facility may be included.

### 6.3.2.6 MNSS\_END\_IND

Receipt of a RELEASE COMPLETE message, the signalling transaction has been released. The indication of a supplementary service facility may be included.

## 6.4 Short Message Services Support

The service provided by the CM sublayer to support the short message service are defined in GSM 04.11.

## 6.5 Session Management Services for GPRS-Services

Session Management services are provided at the SMREG-SAP and the SNSM-SAP for anonymous and non-anonymous access. The non-anonymous and anonymous access procedures for PDP context activation and PDP context deactivation are available at the SMREG-SAP. In addition there exists a PDP context modification for non-anonymous PDP contexts.

Before SMDCP initiates any user data transfer, the PDP context activation procedure must be performed.

## 6.5.1 Session Management Services for SMREG-SAP

**Table 6.5: Primitives and Parameters at SMREG-SAP - MS side**

PRIMITIVE	PARAMETER (message, info elements of message, other parameters)	REFERENCE
SMREG-PDP-ACTIVATE-REQ	PDP type, QoS, NSAPI, APN, Data mode	6.5.1.1
SMREG-PDP-ACTIVATE-CNF	PDP type, PDP address, QoS, NSAPI, PDP config options	6.5.1.2
SMREG-PDP-ACTIVATE-REJ	cause	6.5.1.3
SMREG-PDP-ACTIVATE-IND	PDP type, QoS, NSAPI, APN	6.5.1.4
SMREG-PDP-DEACTIVATE-REQ	NSAPI(s)	6.5.1.5
SMREG-PDP-DEACTIVATE-CNF	NSAPI(s)	6.5.1.6
SMREG-PDP-DEACTIVATE-IND	NSAPI(s)	6.5.1.7
SMREG-PDP-MODIFY-IND	QoS(s), NSAPI(s)	6.5.1.8
SMREG-AA-PDP-ACTIVATE-REQ	server address, QoS, NSAPI, Data mode	6.5.1.9
SMREG-AA-PDP-ACTIVATE-CNF	QoS	6.5.1.10
SMREG-AA-PDP-ACTIVATE-REJ	cause	6.1.5.11
SMREG-AA-PDP-DEACTIVATE-REQ	NSAPI	6.5.1.12
SMREG-AA-PDP-DEACTIVATE-IND	NSAPI	6.5.1.13

### 6.5.1.1 SMREG-PDP-ACTIVATE-REQ

The MS initiates a PDP context activation. SM is requested to send the ACTIVATE PDP CONTEXT REQUEST message to the network. The PDP context is pending activation.

### 6.5.1.2 SMREG-PDP-ACTIVATE-CNF

The MS initiated PDP context activation succeeded. The network confirmed the PDP context activation, i.e. the ACTIVATE PDP CONTEXT ACCEPT message was received from the network. Then SM has ordered SMDCP to establish the needed LLC links. The PDP context is active.

### 6.5.1.3 SMREG-PDP-ACTIVATE-REJ

The PDP context activation failed, the PDP context is not activated. One reason for failure is that the network rejected the activation attempt, which means the ACTIVATE PDP CONTEXT FAILURE message was received. Another reason is e.g. that it was not possible to establish the needed LLC links.

### 6.5.1.4 SMREG-PDP-ACTIVATE-IND

The network asked for a PDP context activation. The REQUEST PDP CONTEXT ACTIVATION message was received from the network. The MS reacts either by initiating a new PDP context activation or by rejecting the network's request.

#### 6.5.1.5 SMREG-PDP-DEACTIVATE-REQ

The MS initiates a PDP context deactivation: SM is requested to send a DEACTIVATE PDP CONTEXT REQUEST message to the network. The PDP context is pending deactivation.

#### 6.5.1.6 SMREG-PDP-DEACTIVATE-CNF

The MS initiated PDP context deactivation has been done. The network confirmed the PDP context activation, i.e. the ACTIVATE PDP CONTEXT ACCEPT message was received from the network. Then SM has ordered SNDCCP to locally release not further needed LLC links. The PDP context has been deactivated.

#### 6.5.1.7 SMREG-PDP-DEACTIVATE-IND

A network initiated a PDP context deactivation has been performed. The DEACTIVATE PDP CONTEXT REQUEST message has been received from the network. The MS has acknowledged with the DEACTIVATE PDP CONTEXT ACCEPT message. The PDP context has been deactivated, Not further needed LLC links were locally released,

#### 6.5.1.8 SMREG-PDP-MODIFY-IND

A network initiated a PDP context modification has been performed. The MODIFY PDP CONTEXT REQUEST message has been received from the network. The modification has been acknowledged by sending the MODIFY PDP CONTEXT ACCEPT message. One or several PDP contexts have been modified. LLC links are adjusted.

#### 6.5.1.9 SMREG-AA-PDP-ACTIVATE-REQ

The MS initiates an anonymous PDP context activation. SM is requested to send the ACTIVATE AA PDP REQUEST message to the network. The anonymous PDP context is pending activation.

#### 6.5.1.10 SMREG-AA-PDP-ACTIVATE-CNF

The MS initiated anonymous PDP context activation succeeded. The network confirmed the PDP context activation, i.e. the ACTIVATE AA PDP CONTEXT ACCEPT message was received from the network. Then SM has ordered SNDCCP to establish the needed LLC links. The anonymous PDP context is active.

#### 6.5.1.11 SMREG-AA-PDP-ACTIVATE-REJ

The PDP context activation failed, the PDP context is not activated. One reason for failure is that the network rejected the activation attempt, which means the AA ACTIVATE PDP CONTEXT FAILURE message was received. Another reason is e.g. that it was not possible to establish the needed LLC links.

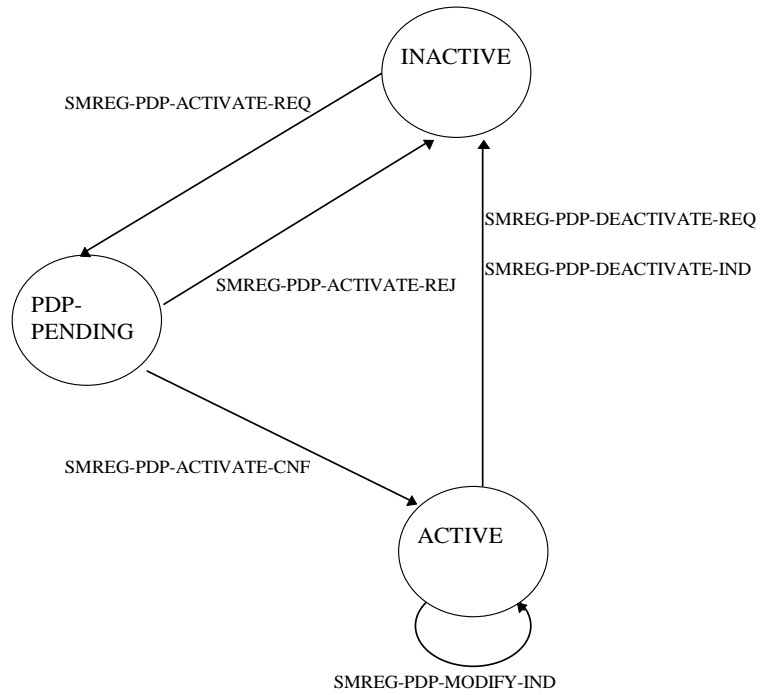
#### 6.5.1.12 SMREG-AA-PDP-DEACTIVATE-REQ

The MS initiates the anonymous PDP context deactivation:

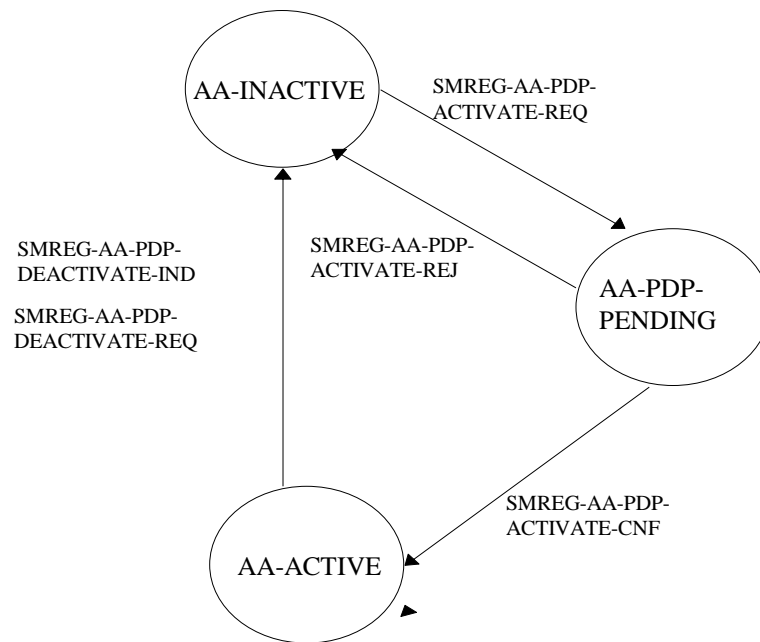
#### 6.5.1.13 SMREG-AA-PDP-DEACTIVATE-IND

The MS anonymous PDP context deactivation has been performed. For example the MS's ready timer has expired, or the MS has left the routing area. Also the network may have requested deactivation, which means a DEACTIVATE AA PDP CONTEXT REQUEST message was received from the network.

The session management services provided at the service access point SMREG-SAP are illustrated in the state machines of figure 6.4 and 6.5 below. Note, that the state machine describes only one PDP context within the SM entity.



**Figure 6.4: Session Management service states at the SMREG-SAP for GPRS non-anonymous PDP context handling - MS side**



**Figure 6.5: Session management services states at SMREG-SAP for GPRS anonymous services - MS side**

## 6.5.2 Session Management Services for SNSM-SAP

### 6.5.2.1 Service primitives

This section is informative, the service primitives are defined in GSM 04.65 [12]. They are included here to provide a complete overview of the radio interface protocol architecture.

**Table 6.5.2: Service primitives and parameters at SNSM-SAP - MS side**

PRIMITIVE	PARAMETER (message, info elements of message, other parameters)	REFERENCE
SNSM-ACTIVATE-IND	NSAPI, QoS, SAPI	6.5.2.1.1
SNSM-ACTIVATE-RSP	-	6.5.2.1.2
SNSM-DEACTIVATE-IND	NSAPI	6.5.2.1.3
SNSM-DEACTIVATE-RSP	-	6.5.2.1.4
SNSM-MODIFY-IND	NSAPI, QoS, SAPI	6.5.2.1.5
SNSM-MODIFY-RSP	-	6.5.2.1.6
SNSM-STATUS-REQ	-	6.5.2.1.7

#### 6.5.2.1.1 SNSM-ACTIVATE-IND

Indication used by the SM entity to inform the SMDCP entity that an NSAPI has been activated for data transfer. It also informs the SMDCP entity about the negotiated QoS profile and the SAPI assigned for this NSAPI. The request is sent by SM towards SMDCP during an ongoing PDP context activation procedure.

#### 6.5.2.1.2 SNSM-ACTIVATE-RSP

Response used by the SMDCP entity to inform the SM entity that the indicated NSAPI is now in use and that the acknowledged peer-to-peer LLC operation for the indicated SAPI is established, if necessary.

#### 6.5.2.1.3 SNSM-DEACTIVATE-IND

Indication used by the SM entity to inform the SMDCP entity that an NSAPI has been deallocated and cannot be used by the SMDCP entity anymore. The request is sent by SM towards SMDCP during an ongoing MS initiated as well as network initiated PDP context activation procedure.

#### 6.5.2.1.4 SNSM-DEACTIVATE-RSP

Response used by the SMDCP entity to inform the SM entity that the NSAPI indicated is no longer in use and that the acknowledged peer-to-peer LLC operation for the associated SAPI is released, if necessary.

#### 6.5.2.1.5 SNSM-MODIFY-IND

Indication used by the SM entity to trigger change of the QoS for an NSAPI and indication of the SAPI to be used. The request is sent by SM towards SMDCP during an ongoing PDP context modification procedure.

#### 6.5.2.1.6 SNSM-MODIFY-RSP

Response used by the SMDCP entity to inform the SM entity that the indicated NSAPI and QoS profile are now in use and the acknowledged peer-to-peer LLC operations for the appropriate SAPIs are established and/or released, if necessary.

### 6.5.2.1.7 SNSM-STATUS-REQ

This primitive is used by the SNDCP entity to inform the SM entity that SNDCP cannot continue its operation due to errors at the LLC layer (as indicated with LL-Release.indication) or at the SNDCP layer. The Cause parameter indicates the cause of the error.

## 6.6 Registration Services for GPRS-Services

The attach/detach procedures comprise the registration services which are provided at the GMMREG-SAP for non-anonymous access.

It shall be noted, that the registration services for mobiles of class A or B may depend on the service states for GPRS and non-GPRS services. Therefore the internal access points MMCOORD and the GMMCOORD ( see figure 5.3) are used by GMM and MM to inform each other about the relevant conditions. No service primitives between the entities within the same sublayer, i.e. the MM sublayer, are defined in 04.07. The Mobility Management for class A and B mobiles is further specified in 04.08.

### 6.6.1 Registration Services for GMMREG-SAP

**Table 6.6.1: Service primitives and parameters at GMMREG-SAP - MS side**

PRIMITIVE	PARAMETER (message, info elements of message, other parameters)	REFERENCE
GMMREG-ATTACH-REQ	attach-type, READY-timer, STANDBY-timer	6.6.1.1
GMMREG-ATTACH-CNF	PLMNs MT-caps, attach-type.	6.6.1.2
GMMREG-ATTACH-REJ	cause	6.6.1.3
GMMREG-DETACH-REQ	detach-type, power-off/normal-detach	6.6.1.4
GMMREG-DETACH-CNF	detach-type	6.6.1.5
GMMREG-DETACH-IND	detach-type	6.6.1.6

#### 6.6.1.1 GMMREG-ATTACH-REQ

MS initiates the GPRS and/or IMSI attach. GMM is requested to send an ATTACH REQUEST message to the network. The attachment is registration pending in the MS.

#### 6.6.1.2 GMMREG-ATTACH-CNF

The attach (either GPRS-attach or IMSI-attach or both) was successful. The network confirmed the attach, i.e. the ATTACH ACCEPT message was received by the MS. The LLC and RR sublayer will be informed by GMM about the TLLI to be used.

#### 6.6.1.3 GMMREG-ATTACH-REJ

The attach (either GPRS-attach or IMSI-attach or both) has failed. The network rejected the attach attempt, i.e. the message ATTACH REJECT was received from the network.

#### 6.6.1.4 GMMREG-DETACH-REQ

MS initiates GPRS and/or IMSI detach: GMM is requested to send a DETACH REQUEST message, the detach procedure is initiated. In case of MS initiated detach at power-off, the procedure is terminated in the MS after sending the DETACH REQUEST message.



### 6.6.1.5 GMMREG-DETACH-CNF

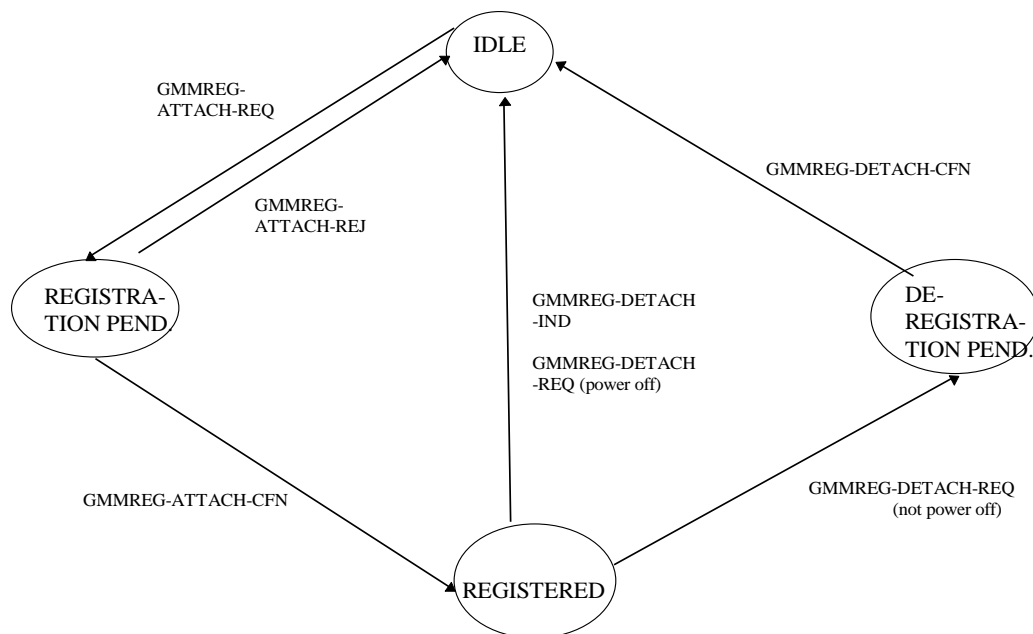
The MS initiated detach (either GPRS-attach or IMSI-attach or both) has been completed.

The network confirmed the detach, i.e. the message DETACH ACCEPT was received from the network. This finalises the detach procedure (normal, not at power off). Any PDP context possibly activated before is deactivated.

### 6.6.1.6 GMMREG-DETACH-IND

A network initiated detach has been performed. Or the detach has been performed locally due to expiration of the standby timer or a failed routing area update. In the first case the DETACH REQUEST message was from the network. Any PDP context possibly activated before is deactivated.

The registration services provided at the service access point GMMREG-SAP are illustrated in the state machine of figure 6.6 below. Note, that in state registered the MS may be suspended from GPRS mobility management due to an ongoing CS connection. The registration procedure Routing Area Updating, which is not provided at the GMMREG-SAP, is not visible within the diagram.



**Figure 6.6: Registration services states at GMMREG-SAP for GPRS non-anonymous attach and detach - MS side.**

## 6.7 Services provided to SMDCP entities by GPRS Logical Link Control services

This section is informative, the service primitives are defined in GSM 04.64 [11]. They are included here to provide a complete overview of the radio interface protocol architecture.

Logical Link Control services are provided at the QoS1-SAP - QoS4 SAP towards the SMDCP and at the LLSMS-SAP towards SMS.

### 6.7.1 Service state diagram for QoS1-SAP, QoS2-SAP, QoS3-SAP and QoS4-SAP

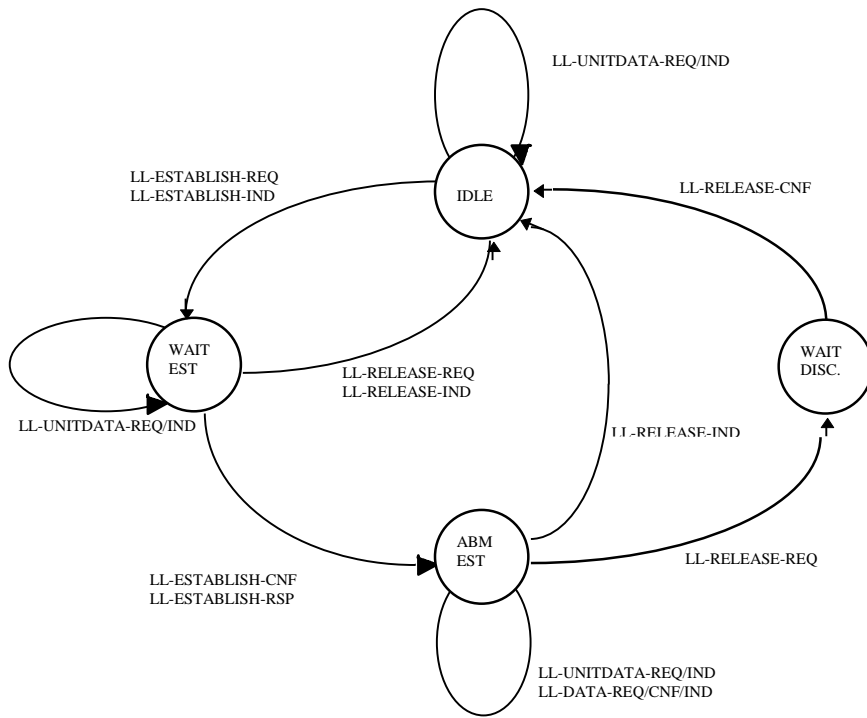


Figure 6.7: States to establish and release ABM mode operation

## 6.7.2 Service primitives for QoS1-SAP, QoS2-SAP, QoS3-SAP and QoS4-SAP

**Table 6.7.2: Service primitives and parameters at QoS1 to QoS4 - MS side**

PRIMITIVE	PARAMETER (message, info elements of message, other parameters)	REFERENCE
LL-ESTABLISH-REQ	TLLI, SNDCP requested parameters (XID)	6.7.2.1
LL-ESTABLISH-CNF	TLLI, SNDCP negotiated parameters (XID)	6.7.2.2
LL-ESTABLISH-IND	TLLI, SNDCP requested parameters (XID), N201	6.7.2.3
LL-ESTABLISH-RSP	TLLI, SNDCP negotiated parameters (XID)	6.7.2.4
LL-RELEASE-REQ	TLLI	6.7.2.5
LL-RELEASE-CFN	TLLI	6.7.2.6
LL-RELEASE-IND	TLLI	6.7.2.7
LL-XID-REQ	TLLI, SNDCP requested parameters (XID)	6.7.2.8
LL-XID-IND	TLLI, SNDCP requested parameters (XID), N201	6.7.2.9
LL-XID-RSP	TLLI, SNDCP negotiated parameters (XID)	6.7.2.10
LL-XID-CNF	TLLI, SNDCP negotiated parameters (XID), N201	6.7.2.11
LL-DATA-REQ	TLLI, N-PDU, local reference	6.7.2.12
LL-DATA-CNF	TLLI, local reference	6.7.2.13
LL-DATA-IND	TLLI, N-PDU	6.7.2.14
LL-UNITDATA-REQ	TLLI, N-PDU, protect, cipher	6.7.2.15
LL-UNITDATA-IND	TLLI, N-PDU	6.7.2.16
LL-STATUS-IND	TLLI, cause	6.7.2.17

### 6.7.2.1 LL-ESTABLISH-REQ

A LLC SABM frame will be sent to establish the LLC ABM mode

### 6.7.2.2 LL-ESTABLISH-CNF

A LLC UA frame is received, the LLC ABM mode has been established

### 6.7.2.3 LL-ESTABLISH-IND

A LLC SABM frame is received

### 6.7.2.4 LL-ESTABLISH-RSP

A LLC UA frame will be sent, the ABM mode is established

**6.7.2.5 LL-RELEASE-REQ**

A LLC DISC frame will be sent to change to LLC ADM mode

**6.7.2.6 LL-RELEASE-CNF**

The LLC link has been disconnected, LLC is in ADM mode

**6.7.2.7 LL-RELEASE-IND**

LLC is in idle mode

**6.7.2.8 LL-XID-REQ**

An LLC XID frame will be sent

**6.7.2.9 LL-XID-IND**

An LLC XID frame has been received

**6.7.2.10 LL-XID-RSP**

An LLC XID frame will be sent as a response to a received XID frame

**6.7.2.11 LL-XID-CNF**

An LLC XID frame has been received as a response to a sent XID frame

**6.7.2.12 LL-DATA-REQ**

An LLC I frame will be sent to the peer entity

**6.7.2.13 LL-DATA-CNF**

Successful reception of an LLC I frame has been acknowledged by the peer entity

**6.7.2.14 LL-DATA-IND**

An LLC I frame has been received from the peer entity

**6.7.2.15 LL-UNITDATA-REQ**

An LLC UI frame will be sent to the peer entity

**6.7.2.16 LL-UNITDATA-IND**

An LLC UI frame has been received from the peer entity

**6.7.2.17 LL-STATUS-IND**

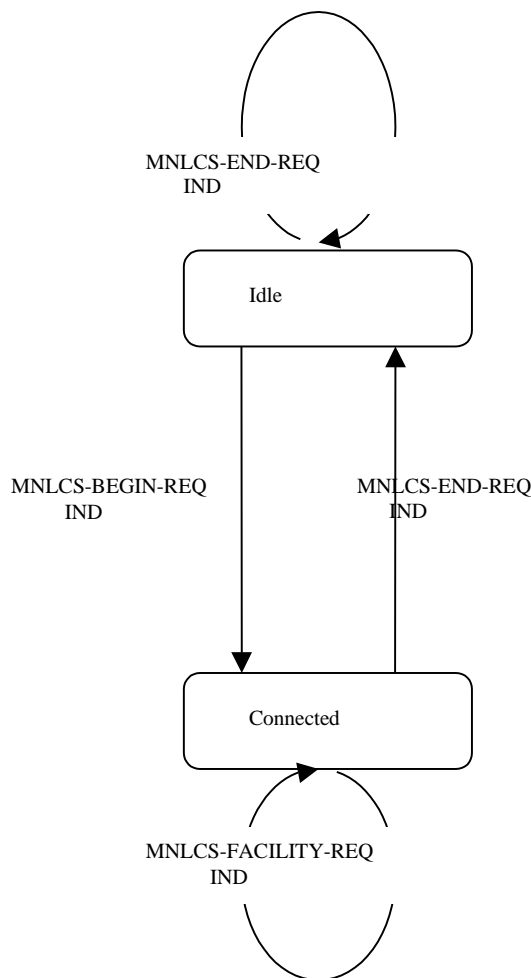
Indication used by LLC to transfer LLC failures to the SNDCP sublayer. The failure may also be caused due to errors at the RLC/MAC layer.

## 6.8 Location services at the MS side

The location services (initiation of positioning measurements at the MS are provided at the service access point MNLCS-SAP. The service provided by the CM sublayer to support the location services is defined in GSM 04.71.

### 6.8.1 Service state diagram

The positioning services provided at the service access point MNLCS-SAP are illustrated in the state diagram of figure 6.8.



STATES:

IDLE - No LCS signalling transaction pending

CONN - LCS signalling transaction established

**Figure 6.8: Service graph of the Location Services Support entity - MS side**

### 6.8.2 Service primitives

**Table 6.8: Primitives and Parameters at MNLCS-SAP - MS side**

PRIMITIVES	PARAMETERS (Info elements of message)	REFERENCE
MNLCS_BEGIN_REQ	REGISTER	6.8.2.1
MNLCS_BEGIN_IND	REGISTER	6.8.2.2

MNLCS_FACILITY_REQ	FACILITY	6.8.2.3
MNLCS_FACILITY_IND	FACILITY	6.8.2.4
MNLCS_END_REQ	RELEASE COMPLETE	6.8.2.5
MNLCS_END_IND	RELEASE COMPLETE	6.8.2.6

### 6.8.2.1 MNLCS\_BEGIN\_REQ

Request to send a REGISTER message in order to establish a signalling transaction for the provision of location services. The request for transfer of a location service facility may be included

### 6.8.2.2 MNLCS\_BEGIN\_IND

Receipt of a REGISTER message, a signalling transaction is established for the provision of location services after receipt of a REGISTER message. The indication of a location service facility may be included.

### 6.8.2.3 MNLCS\_FACILITY\_REQ

Request to send a FACILITY message for the provision of a location service invocation. The request for transfer of a location service facility may be included.

### 6.8.2.4 MNLCS\_FACILITY\_IND

Receipt of a FACILITY message, a location service facility has been requested

### 6.8.2.5 MNLCS\_END\_REQ

Request to send a RELEASE COMPLETE message in order to release the signalling transaction. The request for transfer of a location service facility may be included.

### 6.8.2.6 MNLCS\_END\_IND

Receipt of a RELEASE COMPLETE message, the signalling transaction has been released. The indication of a location service facility may be included.

---

## 7 Services provided by signalling layer 3 on the Network side

In this clause, the services provided by signalling layer 3 on the network side are described which belong to the CM sub-layer functional blocks of CC, SMS, and SS. The services corresponding to further functional blocks of the CM sublayer are not further described in this clause.

### 7.1 Call control services

The Call Control services are provided by multiple CC entities at the service access point MNCC-SAP.

The Call Control service class consists of the following services:

- call establishment;
- call maintaining;
- call termination;
- call related Supplementary Services Support.

### 7.1.1 Service state diagram

The Call Control services provided at the service access point MNCC-SAP are illustrated in figure 7.1.

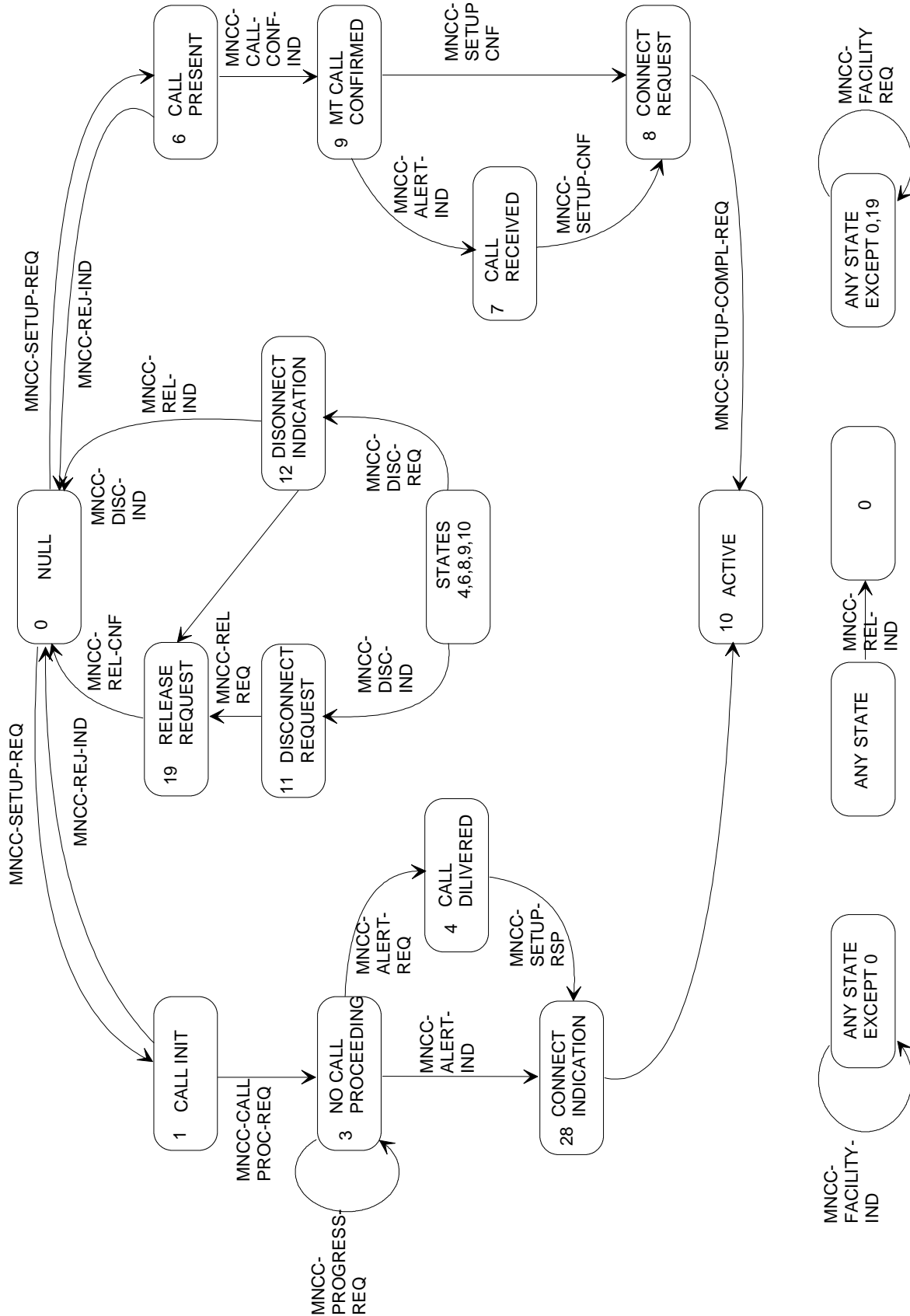


Figure 7.1: (page 1 of 2) Service graph of Call Control entity - Network side

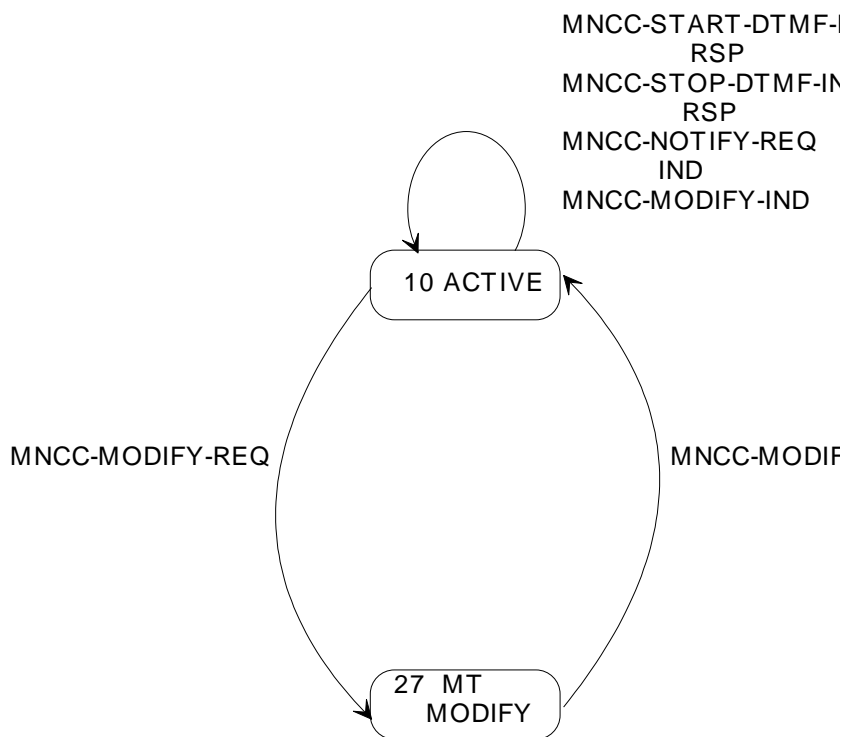


Figure 7.1: (page 2 of 2) Service graph of Call Control entity - Network side



## 7.1.2 Service primitives

**Table 7.1: Primitives and Parameters at MNCC-SAP - Network side**

PRIMITIVE	PARAMETER (message, info elements of message, other parameters)	REFERENCE
MNCC_SETUP_REQ	SETUP incl. Mobile ID or EMERGENCY SETUP	7.1.2.1
MNCC_SETUP_IND	SETUP	7.1.2.2
MNCC_SETUP_RSP	CONNECT	7.1.2.3
MNCC_SETUP_CNF	CONNECT	7.1.2.4
MNCC_SETUP_COMPL_REQ	CONNECT ACKNOWLEDGE	7.1.2.5
MNCC_SETUP_COMPL_IND	CONNECT ACKNOWLEDGE	7.1.2.6
MNCC_REJ_REQ	RELEASE COMPLETE	7.1.2.7
MNCC_REJ_IND	cause	7.1.2.8
MNCC_CALL_CONF_IND	CALL CONFIRMED	7.1.2.9
MNCC_CALL_PROC_REQ	CALL PROCEEDING	7.1.2.10
MNCC_PROGRESS_REQ	PROGRESS	7.1.2.11
MNCC_ALERT_REQ	ALERTING	7.1.2.12
MNCC_ALERT_IND	ALERTING	7.1.2.13
MNCC_NOTIFY_REQ	NOTIFY	7.1.2.14
MNCC_NOTIFY_IND	NOTIFY	7.1.2.15
MNCC_DISC_REQ	DISCONNECT	7.1.2.16
MNCC_DISC_IND	DISCONNECT	7.1.2.17
MNCC_REL_REQ	RELEASE or DISCONNECT	7.1.2.18
MNCC_REL_IND	RELEASE	7.1.2.19
MNCC_REL_CNF	RELEASE or RELEASE COMPLETE	7.1.2.20
MNCC_FACILITY_REQ	facility	7.1.2.21
MNCC_FACILITY_IND	facility	7.1.2.22
MNCC_START_DTMF_IND	START DTMF	7.1.2.23
MNCC_START_DTMF_RSP	START DTMF ACK or START DTMF REJ	7.1.2.24
MNCC_STOP_DTMF_IND	STOP DTMF	7.1.2.25
MNCC_STOP_DTMF_RSP	STOP DTMF ACK	7.1.2.26
MNCC_MODIFY_REQ	MODIFY or BC-parameter	7.1.2.27
MNCC_MODIFY_IND	BC-parameter	7.1.2.28
MNCC_MODIFY_RES	MODIFY COMPLETE	7.1.2.29
MNCC_MODIFY_CNF	BC-parameter	7.1.2.30

### 7.1.2.1 MNCC\_SETUP\_REQ

Request to send a SETUP message to initiate Mobile terminated establishment.

### 7.1.2.2 MNCC\_SETUP\_IND

Receipt of a SETUP or EMERGENCY SETUP message, the Mobile originating call establishment has been initiated.

### 7.1.2.3 MNCC\_SETUP\_RSP

Response to send a CONNECT message to indicate call acceptance by the remote user.

#### 7.1.2.4 MNCC\_SETUP\_CNF

Receipt of a CONNECT message, the Mobile terminated call has been accepted.

#### 7.1.2.5 MNCC\_SETUP\_COMPL\_REQ

Request to send a CONNECT ACKNOWLEDGE message, the Mobile terminated call establishment has been completed.

#### 7.1.2.6 MNCC\_SETUP\_COMPL\_IND

Indication of the receipt of a CONNECT ACKNOWLEDGE message, the Mobile originating call establishment has been completed.

#### 7.1.2.7 MNCC\_REJ\_REQ

Reject the Mobile originated call establishment if the call cannot be accepted.

#### 7.1.2.8 MNCC\_REJ\_IND

A Mobile terminated call was rejected by the MS, e.g. because of missing compatibility.

#### 7.1.2.9 MNCC\_CALL\_CONF\_IND

Receipt of a CALL CONFIRMED message, the Mobile terminated call has been confirmed. A bearer capability different from that given in MNCC\_SETUP\_REQ may be offered to the remote calling user.

#### 7.1.2.10 MNCC\_CALL\_PROC\_REQ

Request to send a CALL PROCEEDING message to indicate to the Mobile originating user that call establishment has been initiated in the Network and no more call establishment information will be accepted.

#### 7.1.2.11 MNCC\_PROGRESS\_REQ

Request to send a PROGRESS message or to piggy-back a progress IE in a suitable CC message in order to give the Mobile user information about the call, e.g., that the call is progressing in the PLMN/ISDN environment, or that the call has left the PLMN/ISDN environment, or that in-band tones/announcement are available.

#### 7.1.2.12 MNCC\_ALERT\_REQ

Request to send an ALERTING message to indicate to the Mobile originating user that remote called user alerting has been initiated.

#### 7.1.2.13 MNCC\_ALERT\_IND

Receipt of an ALERTING message from the Mobile terminated user to be sent to the remote calling user to indicate that user alerting has been initiated.

#### 7.1.2.14 MNCC\_NOTIFY\_REQ

Request to send information pertaining to a call, such as user suspended, to the Mobile originating or the Mobile terminated user.

#### 7.1.2.15 MNCC\_NOTIFY\_IND

Indication from the Mobile originating or Mobile terminated user of information pertaining to a call, such as remote user suspended.

**7.1.2.16 MNCC\_DISC\_REQ**

Request to send a DISCONNECT message to the MS in order to clear the end-to-end connection.

**7.1.2.17 MNCC\_DISC\_IND**

Receipt of a DISCONNECT message, the MS indicates that the end-to-end connection is cleared.

**7.1.2.18 MNCC\_REL\_REQ**

Request to send a RELEASE message to inform the MS that the network intends to release the MM connection and the correspondent call reference.

**7.1.2.19 MNCC\_REL\_IND**

Receipt of a RELEASE message, the MS intends to release its MM connection and call reference. The Network is requested to release its call reference and MM connection.

**7.1.2.20 MNCC\_REL\_CNF**

The RELEASE COMPLETE message has been received, the MM connection in the MS has been released, the Network itself shall release its MM connection and the corresponding call reference.

**7.1.2.21 MNCC\_FACILITY\_REQ**

Request to transport a *facility* IE for call related supplementary service invocations.

**7.1.2.22 MNCC\_FACILITY\_IND**

Indication that a *facility* IE for call related supplementary service invocations has been received.

**7.1.2.23 MNCC\_START\_DTMF\_IND**

Indicate the receipt of a START DTMF message in order to start a DTMF control operation.

**7.1.2.24 MNCC\_START\_DTMF\_RSP**

Request to send a START DTMF ACKNOWLEDGE or START DTMF REJECT message in order to acknowledge or reject the start of a DTMF control operation.

**7.1.2.25 MNCC\_STOP\_DTMF\_IND**

Indicate the receipt of a STOP DTMF message in order to stop a DTMF control operation.

**7.1.2.26 MNCC\_STOP\_DTMF\_RSP**

Request to send a STOP DTMF ACKNOWLEDGE message in order to acknowledge the completion of a DTMF control operation.

**7.1.2.27 MNCC\_MODIFY\_REQ**

Request to start the Mobile terminating in-call modification.

**7.1.2.28 MNCC\_MODIFY\_IND**

Receipt of a MODIFY message, the Mobile originating in-call modification has been initiated.

7.1.2.29 MNCC\_MODIFY\_RES

Response to send a MODIFY COMPLETE to indicate to the Mobile user that the mobile originating in-call modification procedure has been completed.

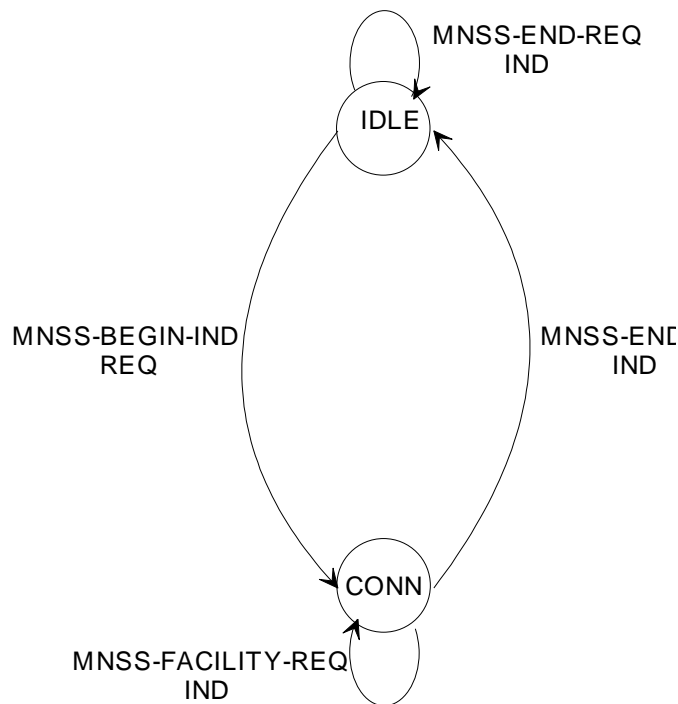
7.1.2.30 MNCC\_MODIFY\_CNF

Confirmation that the Mobile terminating in-call modification has been completed.

7.2 Call independent Supplementary Services Support

7.2.1 Service state diagram

The primitives provided by the call independent Supplementary Services Support entity and the transitions between permitted states are shown in the service graph of figure 7.2 below.



STATES:

IDLE - No SS signalling transaction pending

CONN - SS signalling transaction established

Figure 7.2: Service graph of the call independent Supplementary Services Support entity - Network side

## 7.2.2 Service primitives

**Table 7.2: Primitives and Parameters at MNSS-SAP - Network side**

PRIMITIVES	PARAMETERS (Info elements of message)	REFERENCE
MNSS_BEGIN_REQ	REGISTER	7.2.2.1
MNSS_BEGIN_IND	REGISTER	7.2.2.2
MNSS_FACILITY_REQ	FACILITY	7.2.2.3
MNSS_FACILITY_IND	FACILITY	7.2.2.4
MNSS_END_REQ	RELEASE COMPLETE	7.2.2.5
MNSS_END_IND	RELEASE COMPLETE	7.2.2.6

### 7.2.2.1 MNSS\_BEGIN\_REQ

Request to send a REGISTER message in order to establish a signalling transaction for the provision of call independent supplementary services. The request for a supplementary service invocation may be included.

### 7.2.2.2 MNSS\_BEGIN\_IND

Receipt of a REGISTER message, a signalling transaction is established for the provision of call independent supplementary services. The indication of a supplementary service invocation may be included.

### 7.2.2.3 MNSS\_FACILITY\_REQ

Request to send a FACILITY message for the provision of a call independent supplementary service facility.

### 7.2.2.4 MNSS\_FACILITY\_IND

Receipt of a FACILITY message, a supplementary service facility has been requested.

### 7.2.2.5 MNSS\_END\_REQ

Request to send a RELEASE COMPLETE message in order to release the signalling transaction by sending a RELEASE COMPLETE message. The request for transfer of a supplementary service facility may be included.

### 7.2.2.6 MNSS\_END\_IND

Indication that the signalling transaction has been released after receipt of a RELEASE COMPLETE message. The indication of a supplementary service facility may be included.

## 7.3 Short Message Services Support

The service provided by the CM sublayer to support the short message service are defined in GSM 04.11.

## 7.4 Services provided to SMDCP and SMS entities by GPRS Logical Link Control services

This section is informative, the service primitives are defined in GSM 04.64 [11]. They are included here to provide a complete overview of the radio interface protocol architecture.

On the network side, Logical Link Control services are provided at the QoS1-SAP - QoS4 SAP towards the SMDCP and at the LLSMS-SAP towards SMS

### 7.4.1 Service state diagram for QoS1-SAP, QoS2-SAP, QoS3-SAP and QoS4-SAP

The service state diagram is identical on the network side is identical to the one shown in figure 6.7 for the mobile side.

### 7.4.2 Service primitives for QoS1-SAP, QoS2-SAP, QoS3-SAP and QoS4-SAP

PRIMITIVE	PARAMETER (message, info elements of message, other parameters)	REFERENCE
LL-ESTABLISH-REQ	TLLI, SNDCP requested parameters (XID)	7.4.2.1
LL-ESTABLISH-CNF	TLLI, SNDCP negotiated parameters (XID), N201	7.4.2.2
LL-ESTABLISH-IND	TLLI, SNDCP requested parameters (XID), N201	7.4.2.3
LL-ESTABLISH-RSP	TLLI, SNDCP negotiated parameters (XID)	7.4.2.4
LL-RELEASE-REQ	TLLI	7.4.2.5
LL-RELEASE-CNF	TLLI	7.4.2.6
LL-RELEASE-IND	TLLI	7.4.2.7
LL-XID-REQ	TLLI, SNDCP requested parameters (XID)	7.4.2.8
LL-XID-IND	TLLI, SNDCP requested parameters (XID), N201	7.4.2.9
LL-XID-RSP	TLLI, SNDCP negotiated parameters (XID)	7.4.2.10
LL-XID-CNF	TLLI, SNDCP negotiated parameters (XID), N201	7.4.2.11
LL-DATA-REQ	TLLI, N-PDU, local reference	7.4.2.12
LL-DATASENT-IND	TLLI, local reference, V(S)	7.4.2.13
LL-DATA-CNF	TLLI, local reference	7.4.2.14
LL-DATA-IND	TLLI, N-PDU	7.4.2.15
LL-UNITDATA-REQ	TLLI, N-PDU, protect, cipher	7.4.2.16
LL-UNITDATA-IND	TLLI, N-PDU	7.4.2.17
LL-STATUS-IND	TLLI, cause	7.4.2.18

#### 7.4.2.1 LL-ESTABLISH-REQ

A LLC SABM frame will be sent to establish the LLC ABM mode.

#### 7.4.2.2 LL-ESTABLISH-CNF

A LLC UA frame is received, the LLC ABM mode has been established.

#### 7.4.2.3 LL-ESTABLISH-IND

A LLC SABM frame is received.

#### 7.4.2.4 LL-ESTABLISH-RSP

A LLC UA frame will be sent, the ABM mode is established.

#### 7.4.2.5 LL-RELEASE-REQ

A LLC DISC frame will be sent to change to LLC ADM mode.

#### 7.4.2.6 LL-RELEASE-CNF

The LLC link has been disconnected, LLC is in ADM mode.

#### 7.4.2.7 LL-RELEASE-IND

LLC is in idle mode.

#### 7.4.2.8 LL-XID-REQ

An LLC XID frame will be sent.

#### 7.4.2.9 LL-XID-IND

An LLC XID frame is received.

#### 7.4.2.10 LL-XID-RSP

An LLC XID frame will be sent as a reply to a received XID frame.

#### 7.4.2.11 LL-XID-CNF

An LLC XID frame has been received as a reply to a sent XID frame.

#### 7.4.2.12 LL-DATA-REQ

An LLC I frame will be sent to the peer entity.

#### 7.4.2.13 LL-DATASENT-IND

The sent LLC frame was sent with the V(S) indicated

#### 7.4.2.14 LL-DATA-CNF

Successful reception of an LLC I frame has been acknowledged by the peer entity.

#### 7.4.2.15 LL-DATA-IND

An LLC I frame has been received from the peer entity.

#### 7.4.2.16 LL-UNITDATA-REQ

An LLC UI frame will be sent to the peer entity.

#### 7.4.2.17 LL-UNITDATA-IND

An LLC UI frame has been received from the peer entity.

### 7.4.2.18 LL-STATUS-IND

Indication used by LLC to transfer LLC failures to the SMDCP sublayer. The failure may also be caused due to errors at the RLC/MAC layer.

## 7.5 Session Management Services for GPRS

On the network side Session Management Services are provided only at the SSM-SAP

### 7.5.1 Session Management Services for SMREG-SAP

**Table 7.5.1: Primitives and Parameters at SMREG-SAP - network side**

PRIMITIVE	PARAMETER (message, info elements of message, other parameters)	REFERENCE
SMREG-PDP-ACTIVATE-REQ	PDP type, PDP address, QoS, NSAPI, APN, Data mode	7.5.1.1
SMREG-PDP-ACTIVATE-REJ	cause	7.5.1.2
SMREG-PDP-DEACTIVATE-REQ	NSAPI(s)	7.5.1.3
SMREG-PDP-DEACTIVATE-CNF	NSAPI(s)	7.5.1.4
SMREG-PDP-MODIFY-REQ	QoS(s), NSAPI(s)	7.5.1.5
SMREG-PDP-MODIFY-CNF	server address, QoS(s), NSAPI(s)	7.5.1.6
SMREG-PDP-MODIFY-REJ	server address, QoS(s), NSAPI(s)	7.5.1.7

#### 7.5.1.1 SMREG-PDP-ACTIVATE-REQ

The network initiates a PDP context activation. SM is requested to send the ACTIVATE PDP CONTEXT REQUEST message to the MS. The PDP context is pending activation. The network expects that the MS continues with a normal MS initiated context activation. Therefore at the SMREG-SAP no confirmation is provided.

#### 7.5.1.2 SMREG-PDP-ACTIVATE-REJ

The network initiated PDP context activation failed. Either the ACTIVATE PDP CONTEXT FAILURE message was received from the MS, or lower layer failure or timer expiry caused abortion of the activation procedure.

#### 7.5.1.3 SMREG-PDP-DEACTIVATE-REQ

The network initiates a PDP context deactivation. SM is requested to send a DEACTIVATE PDP CONTEXT REQUEST message. The PDP context is pending deactivation.

#### 7.5.1.4 SMREG-PDP-DEACTIVATE-CNF

The network initiated PDP context activation has been concluded. The MS confirmed the PDP context activation, i.e. the DEACTIVATE PDP CONTEXT ACCEPT message was received. Then SM ordered SMDCP to locally release those LLC links not further needed by other PDP contexts. The PDP context is deactivated.

#### 7.5.1.5 SMREG-PDP-MODIFY-REQ

The network initiates a modification of the PDP context. SM is requested to send a MODIFY PDP CONTEXT REQUEST message to the MS. The PDP context is pending modification.



### 7.5.1.6 SMREG-PDP-MODIFY-CNF

The PDP context modification has been concluded. The MS confirmed the PDP context modification, i.e. the MODIFY PDP CONTEXT ACCEPT message was received. Then SM ordered SNDCP to adjust LLC links as required. The PDP context is modified.

### 7.5.1.7 SMREG-PDP-MODIFY-REJ

The PDP context modification has been failed. Due to timer expiry or lower layer failure the modification procedure has been aborted.

## 7.5.2 Session Management Services for SNSM-SAP

**Table 7.5.2: Primitives and Parameters at SNSM-SAP - network side**

PRIMITIVE	PARAMETER (message, info elements of message, other parameters)	REFERENCE
SNSM-ACTIVATE-IND	TLLI, NSAPI, QoS, SAPI	7.5.2.1
SNSMM-ACTIVATE-RSP	TLLI,	7.5.2.2
SNSM-DEACTIVATE-IND	TLLI, NSAPI	7.5.2.3
SNSM-DEACTIVATE-RSP	TLLI	7.5.2.4
SNSM-MODIFY-IND	TLLI, NSAPI, QoS, SAPI	7.5.2.5
SNSM-MODIFY-RSP	TLLI	7.5.2.6
SNSM-STATUS-REQ	TLLI, NSAPI, Cause	7.5.2.7
SNSM-WINDOW-IND	TLLI, NSAPI + MS's V(R)s	7.5.2.8

### 7.5.2.1 SNSM-ACTIVATE-IND

Indication used by the SM entity to inform the SNDCP entity that an NSAPI has been activated for data transfer. It also informs the SNDCP entity about the negotiated QoS profile and the SAPI assigned for this NSAPI. The request is sent by SM towards SNDCP during an ongoing PDP context activation procedure.

### 7.5.2.2 SNSM-ACTIVATE-RSP

Response used by the SNDCP entity to inform the SM entity that the indicated NSAPI is now in use and that the acknowledged peer-to-peer LLC operation for the indicated SAPI is established, if necessary.

### 7.5.2.3 SNSM-DEACTIVATE-IND

Indication used by the SM entity to inform the SNDCP entity that an NSAPI has been de-allocated and cannot be used by the SNDCP entity anymore. The request is sent by SM towards SNDCP during an ongoing PDP context activation procedure, or by SM in the old SGSN during an ongoing inter-SGSN routing area update procedure.

### 7.5.2.4 SNSM-DEACTIVATE-RSP

Response used by the SNDCP entity to inform the SM entity that the NSAPI indicated is no longer in use and that the acknowledged peer-to-peer LLC operation for the associated SAPI is released, if necessary.

### 7.5.2.5 SNSM-MODIFY-IND

Indication used by the SM entity to trigger change of the QoS for an NSAPI and indication of the SAPI to be used. It is also used by the SM entity to inform the SNDCP entity that an NSAPI shall be created, together with the (re-)negotiated QoS profile and the SAPI assigned. The former is used during an ongoing PDP context modification procedure. The latter is used in the new SGSN during an ongoing inter-SGSN routing area update procedure.

### 7.5.2.6 SNSM-MODIFY-RSP

Response used by the SNDCP entity to inform the SM entity that the indicated NSAPI and QoS profile are now in use and the acknowledged peer-to-peer LLC operations for the appropriate SAPIs are established and/or released, if necessary.

### 7.5.2.7 SNSM-STATUS-REQ

This primitive is used by the SNDCP entity to inform the SM entity that SNDCP cannot continue its operation due to errors at the LLC layer (as indicated with LL-Release.indication) or at the SNDCP layer. The Cause parameter indicates the cause of the error.

### 7.5.2.8 SNSM-WINDOW-IND

This primitive is used in case of inter SGSN routing area updating. The LLC frames confirmed by the MS are indicated to the SNDCP sublayer. The SNDCP sublayer will retransmit an N-PDU again if the MS has not confirmed all LLC PDUs that belong to the possibly segmented N-PDU.

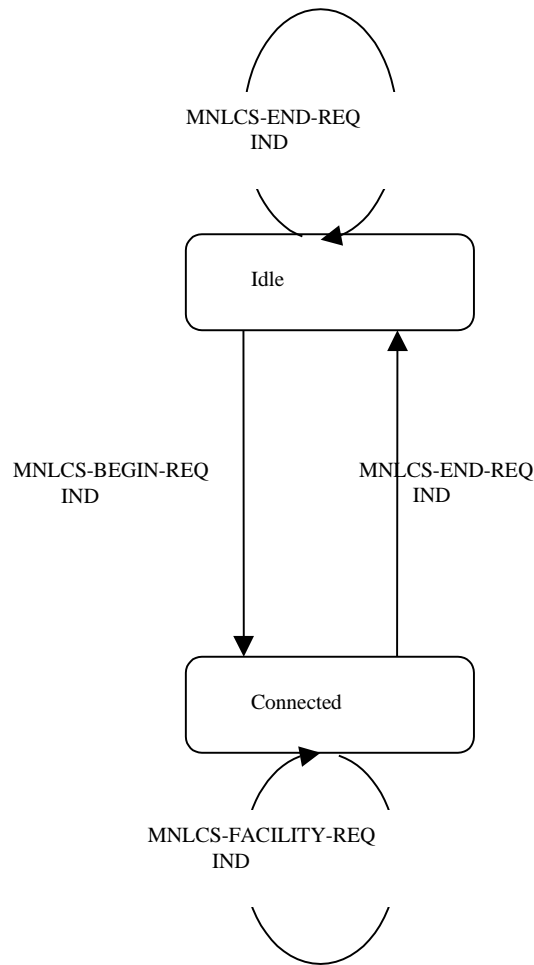
TCP/IP header and V.42bis data compression algorithms shall be reset before N-PDU transmission is resumed.

## 7.6 Location services at the Network side

The location services (initiation of location measurements at the network) are provided at the service access point MNLCS-SAP. The service provided by the CM sublayer to support the location services is defined in GSM 04.71

### 7.6.1 Service state diagram

The primitives provided by the call independent Location Services Support entity and the transitions between permitted states are shown in the service graph of figure 7.6 below.



STATES:

- IDLE - No LCS signalling transaction pending
- CONN - LCS signalling transaction established

Figure 7.6: Service graph of the Location Services Support entity - Network side

### 7.6.2 Service primitives

Table 7.6: Primitives and Parameters at MNLCS-SAP - Network side

PRIMITIVES	PARAMETERS (Info elements of message)	REFERENCE
MNLCS_BEGIN_REQ	REGISTER	7.6.2.1
MNLCS_BEGIN_IND	REGISTER	7.6.2.2
MNLCS_FACILITY_REQ	FACILITY	7.6.2.3
MNLCS_FACILITY_IND	FACILITY	7.6.2.4
MNLCS_END_REQ	RELEASE COMPLETE	7.6.2.5
MNLCS_END_IND	RELEASE COMPLETE	7.6.2.6

#### 7.6.2.1 MNLCS\_BEGIN\_REQ

Request to send a REGISTER message in order to establish a signalling transaction for the provision of location services. The request for a location service invocation may be included.

### 7.6.2.2 MNLCS\_BEGIN\_IND

Receipt of a REGISTER message, a signalling transaction is established for the provision of location services. The indication of a location service invocation may be included.

### 7.6.2.3 MNLCS\_FACILITY\_REQ

Request to send a FACILITY message for the provision of a location service facility.

### 7.6.2.4 MNLCS\_FACILITY\_IND

Receipt of a FACILITY message, a location service facility has been requested.

### 7.6.2.5 MNLCS\_END\_REQ

Request to send a RELEASE COMPLETE message in order to release the signalling transaction by sending a RELEASE COMPLETE message. The request for transfer of a location service facility may be included.

### 7.6.2.6 MNLCS\_END\_IND

Indication that the signalling transaction has been released after receipt of a RELEASE COMPLETE message. The indication of a location service facility may be included.

---

## 8 Services assumed from signalling layers 1 and 2

The services provided by layer 2 are defined in detail in GSM 04.05. A short summary is given below.

In addition, layer 1 communicates directly with layer 3 for information transfer related to channel management and to measurement control. See section 8.5 below.

### 8.1 Priority

Messages from layer 3 can be sent with:

- no priority,  
i.e. the messages are sent in first-in-first-out order;
- priority,  
i.e. a message with this indication is sent as early as possible by layer 2.

### 8.2 Unacknowledged information transfer

Transfer of unacknowledged information using the primitives DL\_UNIT\_DATA\_REQUEST/INDICATION.

### 8.3 Acknowledged information transfer

Transfer of information in multiframe acknowledged mode including:

- establishment of data link connection between L3 entities;
- transfer of information in acknowledged mode;
- release of the data link connection.

The primitives associated with acknowledged information transfer are:

- DL\_ESTABLISH\_REQUEST/INDICATION/CONFIRM for establishment of acknowledged mode;
- DL\_DATA\_REQUEST/INDICATION for requesting the transmission of a message unit and for indicating the reception of a message unit;
- DL\_SUSPEND\_REQUEST/DL\_RELEASE\_CONFIRM for requesting and confirming the suspension of the acknowledged information transfer in the MS upon channel change;
- DL\_RESUME\_REQUEST/DL\_ESTABLISH\_CONFIRM for requesting and confirming the resumption of the acknowledged information transfer in the MS after suspension at channel change;
- DL\_RELEASE\_REQUEST/INDICATION/CONFIRM for the termination of acknowledged mode operation;
- DL\_RECONNECT\_REQUEST for requesting the re-establishment of acknowledged information transfer in the MS on the old channel after channel change failure.

## 8.4 Random access

The transmission/reception of a random access burst is controlled by the primitives DL\_RANDOM\_ACCESS\_REQUEST/INDICATION/CONFIRM.

## 8.5 Channel management and measurements

The management of channels, i.e. their activation, deactivation, configuration, deconfiguration, through-connection and disconnection is controlled by the RR sublayer in layer 3. The measurements performed by the physical layer are also controlled by the RR sublayer of layer 3 and they are reported to layer 3.

These functions use the primitives MPH\_INFORMATION\_REQUEST/INDICATION/CONFIRMATION.

---

# 9 Interlayer service interfaces on the MS side

In addition to the services described in this clause, the RR entity and MM entity also provide services to CM entities which don't belong to the functional blocks of CC, SMS, and SS. (For example, the RR entity provides service to Group Call and Broadcast Call entities.) These services are not further described in this clause.

## 9.1 Services provided by the Radio Resource Management entity

The Radio Resource Management (RR) sublayer provides a service to the Mobility Management entity (MM).

The RR services are used for:

- establishing control channel connections;
- releasing control channel connections;
- control-data transfer.

The Radio Resource Management services are represented by the RR-service primitives.

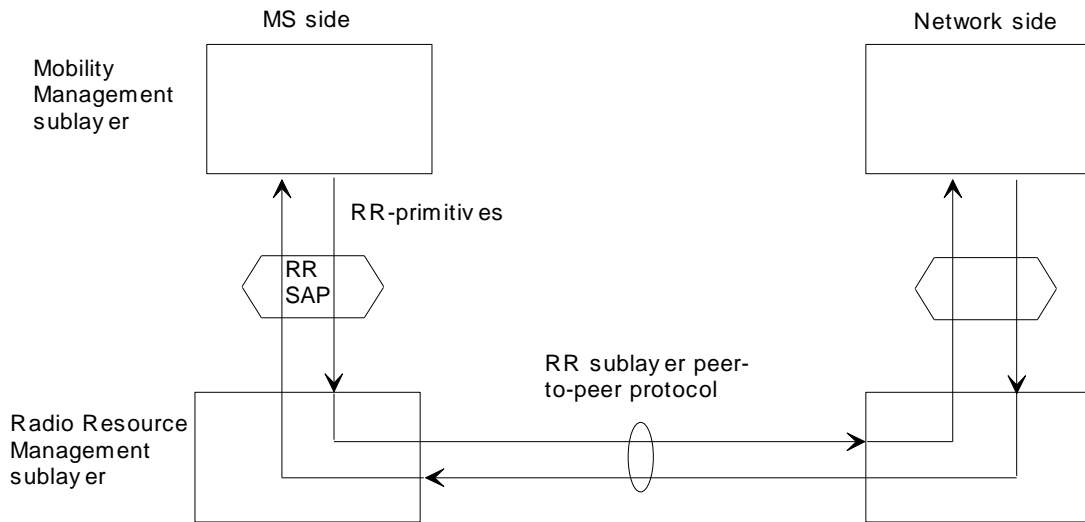


Figure 9.1: Services provided at RR-SAP - MS side

### 9.1.1 Service state diagram

The primitives provided by the Radio Resource Management entity and the transition between permitted states are shown in figure 9.2.

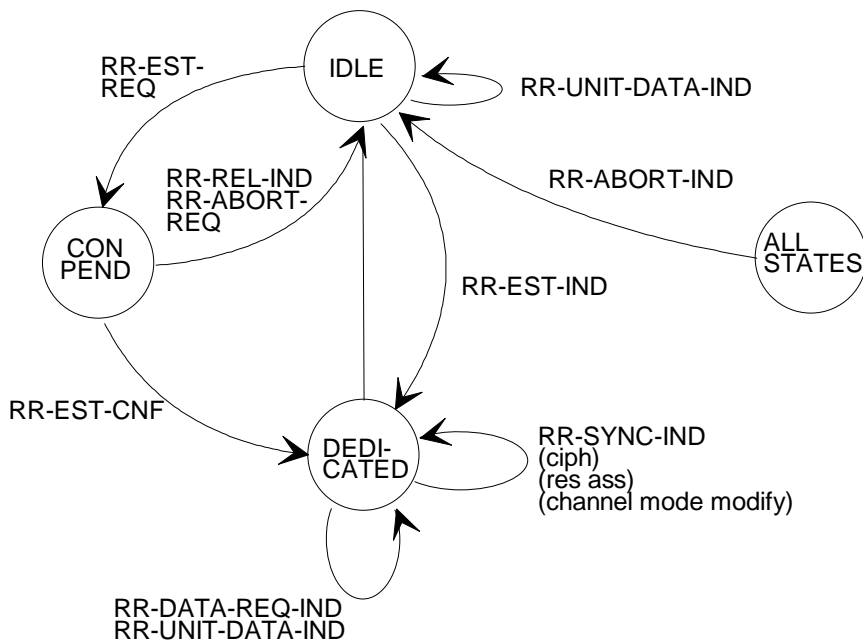


Figure 9.2: Service graph of the Radio Resource Management - MS side

## 9.1.2 Service primitives

**Table 9.1: Primitives and parameters at the RR-SAP - MS side**

PRIMITIVES	PARAMETERS	REFERENCE
RR_EST_REQ	Layer 3 message transferred in the SABM frame	9.1.2.1
RR_EST_IND	-	9.1.2.2
RR_EST_CNF	-	9.1.2.3
RR_REL_IND	cause	9.1.2.4
RR_SYNC_IND	cause (ciphering, res. ass., channel mode modify)	9.1.2.5
RR_DATA_REQ	Layer 3 message	9.1.2.6
RR_DATA_IND	Layer 3 message	9.1.2.7
RR_UNIT DATA_IND	Layer 3 message	9.1.2.8
RR_ABORT_REQ	cause	9.1.2.9
RR_ABORT_IND	cause	9.1.2.10
RR_ACT_REQ	reselection mode	9.1.2.11

### 9.1.2.1 RR\_EST\_REQ

Is used by the Mobility Management entity to request establishment of a Mobile originated RR connection. The request shall be given only in the IDLE state when the MS listens to the CCCH and the previously selected BCCH.

### 9.1.2.2 RR\_EST\_IND

Indicates to the Mobility Management entity the establishment of a Mobile terminated RR connection. By this indication MM is informed that a transparent connection exists and RR is in the dedicated mode.

### 9.1.2.3 RR\_EST\_CNF

Is used by RR to indicate the successful completion of a Mobile originated RR connection establishment. RR connection exists and RR is in the dedicated mode.

### 9.1.2.4 RR\_REL\_IND

Is used by RR to indicate to the Mobility Management entity the release of a RR connection when RR has received a CHANNEL RELEASE from the Network and has triggered a normal release of the data link layer. It is also used to indicate that a requested RR connection cannot be established. In both cases, RR returns to IDLE mode.

### 9.1.2.5 RR\_SYNC\_IND

Is used for synchronizing RR and the Mobility Management entity after the establishment of a Mobile originated or Mobile terminated RR connection. This indication is provided to MM in the following cases:

- ciphering has been started (ciphering);
- a traffic channel has been assigned (res. ass. = "resource assigned");
- the channel mode has been modified (channel mode modify).

### 9.1.2.6 RR\_DATA\_REQ

Is used by the Mobility Management entity to send control data to its peer entity on the Network side via an existing RR connection.

### 9.1.2.7 RR\_DATA\_IND

Is used by RR to indicate control-data, which has been received from its peer entity on the Network side via an existing RR connection.

### 9.1.2.8 RR\_UNIT\_DATA\_IND

Is used by RR to provide MM with system info. The system info is received on the current BCCH if RR is in the IDLE state. If a RR connection has been established, the system info is received on the SACCH.

### 9.1.2.9 RR\_ABORT\_REQ

Request to abort an existing RR connection or a RR connection in progress. The data link, if already established, shall be released by a normal release procedure (DISC/UA) initiated by the MS. This is the only way the MS can trigger the release of a RR connection in case of exceptional conditions. The RR returns to the IDLE state.

### 9.1.2.10 RR\_ABORT\_IND

Indication that the RR connection has been aborted by a lower layer failure and RR has returned to the IDLE state.

## 9.1.3 Services provided by the Radio Resource Management entity for CTS

Inside the RR sub-layer, the CTS Radio Resource Management (CTS-RR) sublayer provides services to the CTS Mobility Management (CTS-MM) entity.

The CTS-RR services are used for:

- alive check.

The CTS Radio Resource Management services are represented by the CTS-RR-service primitives.

**Table 9.1.3: Primitives and parameters at the RR-SAP - MS side for CTS**

PRIMITIVES	PARAMETERS	REFERENCE
CTS_RR_ALIVE_CHECK_IND	-	9.1.3.1

### 9.1.3.1 CTS\_RR\_ALIVE\_CHECK\_IND

Indicates to the CTS Mobility Management entity that an alive check request has been received from the fixed part.

## 9.2 Services provided by the Mobility Management entity

The Mobility Management (MM) sublayer provides services to the Call Control (CC) entity, the Supplementary Services Support (SS) entity, the Location Services (LCS) entity (only for type A LMU) and the Short Message Service Support (SMS) entity.

The Mobility Management services primitives are discriminated by the MMCC, MMSS, MMLCS and MMSMS prefix.



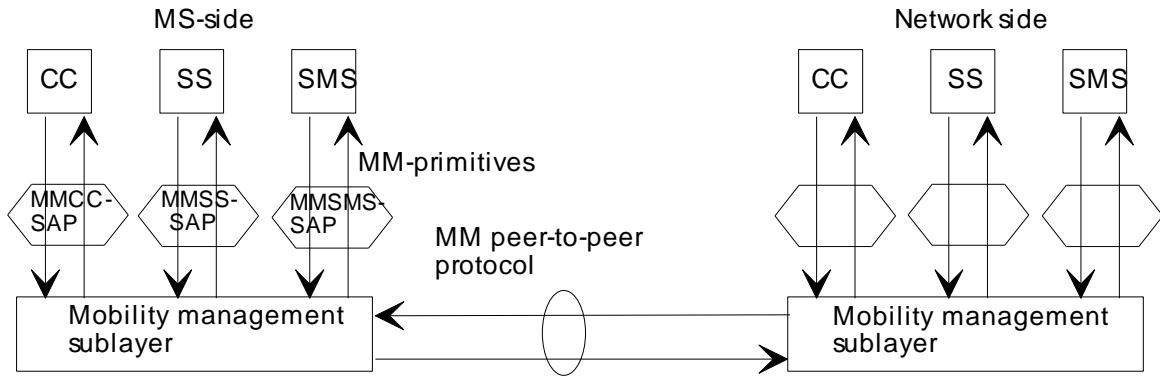
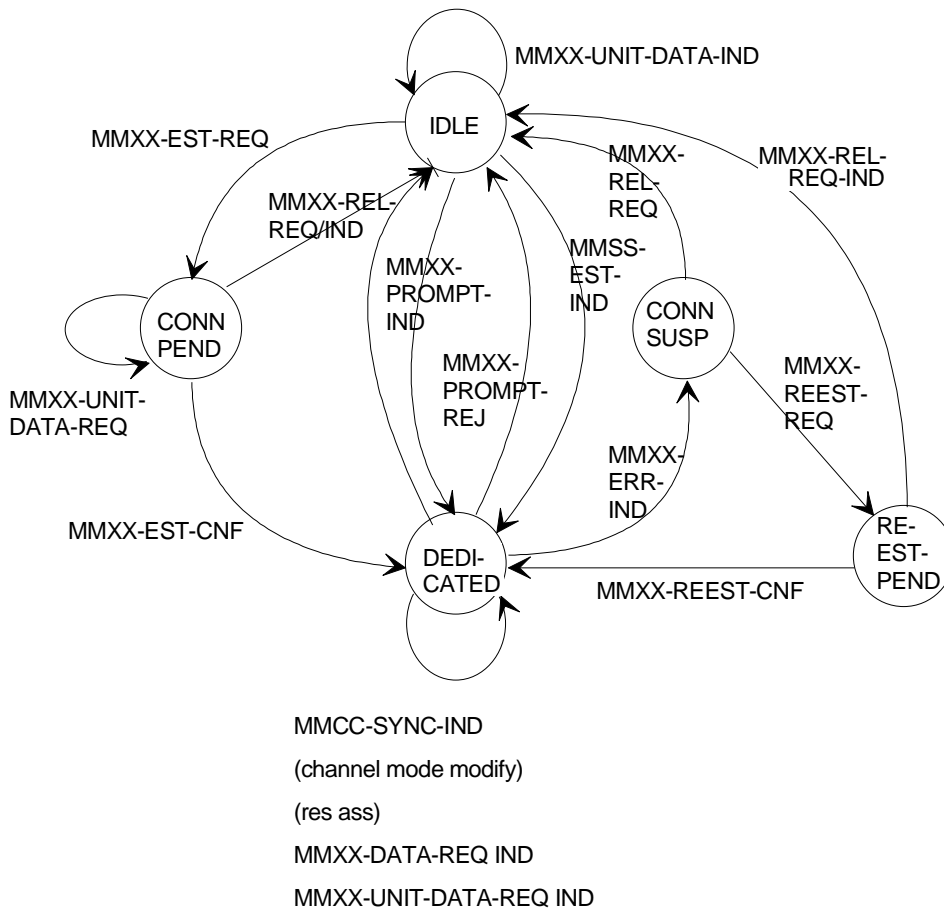


Figure 9.3: Services provided at the MMCC-SAP, MMSS-SAP, MMLCS-SAP, MMSMS-SAP - MS side

(Note: Figure 9.3 shall be updated to include the LCS PD in the same manner as the other PDs are shown)

### 9.2.1 Service state diagram

The primitives provided by the Mobility Management entity towards Call Control, call independent Supplementary Service Support, Location Services Support for type A LMU, and towards Short Messages Service Support and the transition between permitted states are illustrated in figure 9.4.



NOTE 1: MMCC-primitives only at MMCC-SAP.

NOTE 2: The prefix MMXX is used for substitution of MMCC, MMSS, MMLCS or MMSMS.

Figure 9.4: Service graph of the Mobility Management entity - MS side

## 9.2.2 Service primitives

**Table 9.2: Primitives and Parameters at MMCC-SAP, MMSS-SAP, MMLCS-SAP (for type A LMU) or MMSMS-SAP - MS side**

PRIMITIVES	PARAMETERS	REFERENCE
MMXX_EST_REQ (see note 1)	Parameters for the appropriate CM SERVICE REQUEST (if any)	9.2.2.1
MMXX_EST_IND (see note 1)	First CM message	9.2.2.2
MMXX_EST_CNF (see note 1)	-	9.2.2.3
MMXX_REL_REQ (see note 1)	cause	9.2.2.4
MMXX_REL_IND (see note 1)	cause	9.2.2.5
MMXX_DATA_REQ (see note 1)	Layer 3 message	9.2.2.6
MMXX_DATA_IND (see note 1)	Layer 3 message	9.2.2.7
MMXX_UNIT_DATA_REQ (see note 1)	Layer 3 message	9.2.2.8
MMXX_UNIT_DATA_IND (see note 1)	Layer 3 message	9.2.2.9
MMCC_SYNC_IND (see note 2)	cause: res.ass	9.2.2.10
MMXX_REEST_REQ (see note 1)		9.2.2.11
MMXX_REEST_CNF (see note 1)		9.2.2.12
MMXX_ERR_IND (see note 1)	cause	9.2.2.13
MMXX_PROMPT_IND (see note 1)	-	9.2.2.14
MMXX_PROMPT_REJ (see note 1)	-	9.2.2.15
NOTE 1: MMXX is used as substitution for MMCC, MMSS, MMLCS or MMSMS		
NOTE 2: Only at MMCC-SAP		

### 9.2.2.1 MMXX\_EST\_REQ

Request used by CC, SS, LCS (for type A LMU) and SMS respectively, to request establishment of a MM connection. Several MM connections may be provided in parallel to the requesting entities. The primitive may contain parameters which are relevant for the CM SERVICE REQUEST message, e.g. to distinguish a basic call from an emergency call.

### 9.2.2.2 MMXX\_EST\_IND

Indication to CC, SS, LCS (for type A LMU) or SMS that a Mobile terminated MM connection has been established and the first message has been received from the respective peer entity. Several MM connections may be provided in parallel. If a MM connection already exists, a new MM connection using the same RR connection is indicated by this primitive if MM detects a message with a new combination of Protocol Discriminator (PD) and Transaction Identifier (TI).

### 9.2.2.3 MMXX\_EST\_CNF

Successful confirmation of the MM connection establishment by the MM sublayer to be given to the appropriate entity which has requested the service.

### 9.2.2.4 MMXX\_REL\_REQ

Used by CC, SS, LCS (for type A LMU) or SMS respectively, to request release of the MM connection. The corresponding PD/TI will be released and may be used for a new MM connection.

### 9.2.2.5 MMXX\_REL\_IND

Indication of the release of an existing MM connection or a MM connection in progress. This primitive is used in exceptional cases to indicate that the MM connection cannot be established or kept any longer and PD/TI have been released.

#### 9.2.2.6 MMXX\_DATA\_REQ

Request used by the CC, SS or SMS entities for acknowledged control-data transmission.

#### 9.2.2.7 MMXX\_DATA\_IND

Indication used by MM to transfer the received acknowledged control-data to the CC, SS, LCS or SMS entities.

#### 9.2.2.8 MMXX\_UNIT\_DATA\_REQ

Request used by the CC, SS, LCS (for type A LMU) or SMS entities for unacknowledged control-data transmission.

#### 9.2.2.9 MMXX\_UNIT\_DATA\_IND

Indication used by MM to transfer the received unacknowledged control-data to the CC, SS, LCS or SMS entities.

#### 9.2.2.10 MMCC\_SYNC\_IND

Indication that a dedicated channel assignment has been performed and/or the channel mode has been changed (only towards the CC entity).

#### 9.2.2.11 MMXX\_REEST\_REQ

Request to establish a MM connection which has been interrupted by a lower layer failure. The interruption must have been indicated by MMXX\_ERR\_IND.

#### 9.2.2.12 MMXX\_REEST\_CNF

Confirmation of the successful re-establishment of the MM connection. The MM connection will continue with PD/TI as it had before.

#### 9.2.2.13 MMXX\_ERR\_IND

Indication of a lower layer failure interrupting the MM connection. The PD/TI are still kept by MM. In case of parallel transactions this indication is passed to all CM entities for which a MM connection has been established. It is left to the decision of the appropriate CM entity to either request the re-establishment of the MM connection by MMXX\_REEST\_REQ or to release it by MMXX\_REL\_REQ.

#### 9.2.2.14 MMXX\_PROMPT\_IND

Indication given by MM to inform of the completion of the MM connection to the CC, SS, LCS (for type A LMU) or SMS entities for a mobile station which supports "Network Initiated MO CM Connection Request".

#### 9.2.2.15 MMXX\_PROMPT\_REJ

Response to the MMXX\_PROMPT\_IND indication to the MM entity in a mobile station which supports "Network Initiated MO CM Connection Request" in case when it is impossible to establish the prompted CM connection e.g. due to lack of free transaction identifiers.

### 9.3 Services provided by radio resource management entity for GPRS services

This subclause is informative, the service primitives are defined in GSM 04.60 [10]. They are included here to provide a complete overview of the radio interface protocol architecture.

### 9.3.1 Service primitives for GRR-SAP

**Table 9.3.1: Primitives and parameters at GRR-SAP**

<b>PRIMITIVE</b>	<b>PARAMETER</b> (message, info elements of message, other parameters)	<b>REFERENCE</b>
GRR-DATA-REQ	LLC PDU, Priority, Cause	9.3.1.1
GRR-DATA-IND	LLC PDU	9.3.1.2
GRR-UNITDATA-REQ	LLC PDU, Priority	9.3.1.3
GRR-UNITDATA-IND	LLC PDU	9.3.1.4
GRR-STATUS-IND	cause	9.3.1.5

#### 9.3.1.1 GRR-DATA-REQ

Request used by the LL sublayer for acknowledged data transmission with a certain priority. Cause indicates if the GRR-DATA-REQ was triggered as an implicit page response.

#### 9.3.1.2 GRR-DATA-IND

Indication used by RR to transfer received data to the LL sublayer.

#### 9.3.1.3 GRR-UNITDATA-REQ

Request used by the LL sublayer for unacknowledged data transmission with a certain priority.

#### 9.3.1.4 GRR-UNITDATA-IND

Indication used by RR to transfer received data to the LL sublayer.

#### 9.3.1.5 GRR-STATUS-IND

Indication used by RR to transfer RLC/MAC failures to the LL sublayer.

### 9.3.2 Service primitives for GMMRR-SAP

**Table 9.3.2: Primitives and Parameters at GMMRR-SAP - MS side**

<b>PRIMITIVE</b>	<b>PARAMETER</b> (message, info elements of message, other parameters)	<b>REFERENCE</b>
GMMRR-ASSIGN-REQ	newTLLI	9.3.2.1
GMMRR-PAGE-IND	TLLI	9.3.2.2

#### 9.3.2.1 GMMRR-ASSIGN-REQ

A new TLLI is assigned to the RR sublayer.

#### 9.3.2.2 GMMRR-PAGE-IND

A RR-paging message has been received by the RR sublayer.

## 9.4 Services provided by the LLC entity for GPRS services

This subclause is informative, the service primitives are defined in GSM 04.64 [11]. They are included here to provide a complete overview of the radio interface protocol architecture.

### 9.4.1 Service primitives for LLGMM-SAP

**Table 9.4.1: Primitives and parameters at LLGMM-SAP - MS side**

PRIMITIVE	PARAMETER (message, info elements of message, other parameters)	REFERENCE
LLGMM-ASSIGN-REQ	oldTLLI, newTLLI, Kc, RAND, Ciphering Algorithm	9.4.1.1
LLGMM-TRIGGER-REQ	Cause	9.4.1.2
LLGMM-TRIGGER-IND	-	9.4.1.3
LLGMM-SUSPEND-REQ	TLLI	9.4.1.4
LLGMM-RESUME-REQ	TLLI	9.4.1.5
LLGMM-WINDOW-REQ	TLLI, old SGSN's V(R) per SAPI	9.4.1.6
LLGMM-WINDOW-CNF	TLLI, actual MS's LLC's V(R) per SAPI	9.4.1.7
LL-UNITDATA-REQ	TLLI, GMM-PDU, protect, cipher	9.4.1.8
LL-UNITDATA-IND	TLLI, GMM-PDU, cipher	9.4.1.9
LLGMM-STATUS-IND	TLLI, cause	9.4.1.10

#### 9.4.1.1 LLGMM-ASSIGN-REQ

A new TLLI and/or a ciphering key and/or a ciphering algorithm is assigned to the LLC sublayer.

#### 9.4.1.2 LLGMM-TRIGGER-REQ

Request to send an LLC PDU to the network. Cause indicates if the primitive is sent to trigger an implicit page response.

#### 9.4.1.3 LLGMM-TRIGGER-IND

An LLC frame has been transmitted to the network.

#### 9.4.1.4 LLGMM-SUSPEND-REQ

All LLC links in ABM mode will cease sending PDUs. GMM messages can still be sent and received.

#### 9.4.1.5 LLGMM-RESUME-REQ

Normal LLC frame sending and reception is possible again.

#### 9.4.1.6 LLGMM-WINDOW-REQ

Request for the MS's actual LLC's V(R)s.

#### 9.4.1.7 LLGMM-WINDOW-CNF

The actual LLC's V(R)s for each LLC link in ABM mode are transferred to GMM.

#### 9.4.1.8 LL-UNITDATA-REQ

Request to send a GMM message in unacknowledged mode to the peer entity.

#### 9.4.1.9 LL-UNITDATA-IND

A GMM message in unacknowledged mode has been received from the peer entity.

#### 9.4.1.10 LLGMM-STATUS-IND

Indication used by LLC to transfer LLC failures to the GMM sublayer. The failure may also be caused due to errors at the RLC/MAC layer.

### 9.4.2 Service primitives for LLSMS-SAP

**Table 9.4.2: Service primitives and parameters at LLSMS-SAP - MS side**

PRIMITIVE	PARAMETER (message, info elements of message, other parameters)	REFERENCE
LL-UNITDATA-REQ	TLLI, SMS-CP-PDU, protect, cipher	9.4.2.1
LL-UNITDATA-IND	TLLI, SMS-CP-PDU,	9.4.2.2

#### 9.4.2.1 LL-UNITDATA-REQ

An LLC UI frame will be sent to the peer entity

#### 9.4.2.2 LL-UNITDATA-IND

An LLC UI frame has been received from the peer entity

## 9.5 Registration Services provided for GPRS Services

### 9.5.1 Service primitives for GMMSM-SAP

Session management services for non-anonymous may request GPRS service registration before activating a PDP context.

**Table 9.5.1: Primitives and parameters at GMMSM-SAP - MS side**

PRIMITIVE	PARAMETER (message, info elements of message, other parameters)	REFERENCE
GMMSM-ESTABLISH-REQ	-	9.5.1.1
GMMSM-ESTABLISH-CNF	-	9.5.1.2
GMMSM-ESTABLISH-REJ	cause	9.5.1.3
GMMSM-RELEASE-IND	-	9.5.1.4
GMMSM-UNITDATA-REQ	SM-PDU	9.5.1.5
GMMSM-UNITDATA-IND	SM-PDU	9.5.1.6

### 9.5.1.1 GMMSM-ESTABLISH-REQ

Request from Session Management to send an ATTACH REQUEST message to the network to setup a GMM connection. The request is only performed in case the MS is not already attached. The GPRS attach is then indirectly caused by a requested non-anonymous PDP context activation.

### 9.5.1.2 GMMSM-ESTABLISH-CNF

The network has send the ATTACH ACCEPT message to the MS, the indirect attach was successful. Now session management can proceed with PDP context activation.

### 9.5.1.3 GMMSM-ESTABLISH-REJ

The network has rejected the attach. The MS has received the ATTACH REJECT message.

### 9.5.1.4 GMMSM-RELEASE-IND

The GPRS mobility management informs the session management that the MS has been GPRS detached, e.g. by timer expiry, and therefore the PDP contexts are not valid anymore.

### 9.5.1.5 GMMSM-UNITDATA-REQ

The GMM is requested to forward a SM PDU to LLC in order to send it in unacknowledged mode to the peer entity.

### 9.5.1.6 GMMSM-UNITDATA-IND

The GMM forwards a SM PDU, which has been received in unacknowledged mode via LLC from the peer entity.

## 9.5.2 Service primitives for GMMAA-SAP

Session management services for an anonymous PDP require a mobility management entity which does not perform Routing Area Updating, but which requests the termination of the anonymous access in case of change of the RA.

**Table 9.5.2: Primitives and parameters at GMMAA-SAP - MS side**

<b>PRIMITIVE</b>	<b>PARAMETER</b> (message, info elements of message, other parameters)	<b>REFERENCE</b>
GMMAA-ESTABLISH-REQ	-	9.5.2.1
GMMAA-RELEASE-IND	-	9.5.2.2
GMMAA-ETSABLISH-REJ	-	9.5.2.3

### 9.5.2.1 GMMAA-ESTABLISH-REQ

Request from Session Management to perform timer supervision (standby timer set to zero) and to disable routing area updating for anonymous PDP context(s).

### 9.5.2.2 GMMAA-RELEASE-IND

The GPRS mobility management informs the session management that the anonymous PDP contexts are deactivated.

### 9.5.2.3 GMMAA-ESTABLISH-REJ

The GPRS mobility management informs the session management that the anonymous PDP contexts activation was rejected.

## 9.5.3 Service primitives for GMMSMS-SAP

The Short Message entity may request from the GMM entity the GMM IMSI registration state before an MO SMS transmission is initiated.

**Table 9.5.3: Primitives and parameters at GMMSMS-SAP - MS side**

<b>PRIMITIVE</b>	<b>PARAMETER</b> (message, info elements of message, other parameters)	<b>REFERENCE</b>
GMMSMS-REG-STATE-REQ	-	9.5.3.1
GMMSM- REG-STATE -RSP	Registration state	9.5.3.2

### 9.5.3.1 GMMSMS-REG-STATE-REQ

Request for the current IMSI registration state from the Short Message entity.

### 9.5.3.2 GMMSM- REG-STATE -RSP

The current IMSI registration state is sent to the Short Message entity.



## 10 Interlayer service interfaces on the Network side

In addition to the services described in this clause, the RR entity and MM entity also provide services to CM entities which don't belong to the functional blocks of CC, SMS, and SS. (For example, the RR entity provides service to Group Call Control and Broadcast Call Control entities.) These services are not further described in this clause.

### 10.1 Services provided by the Radio Resource Management entity

The Radio Resource Management (RR) sublayer provides services to the Mobility Management entity (MM).

The RR services are used for:

- establishing control channel connections;
- establishing traffic channel connections;
- ciphering mode indication;
- releasing control channel connections;
- control-data transfer.

The Radio Resource Management services are represented by the RR service primitives.

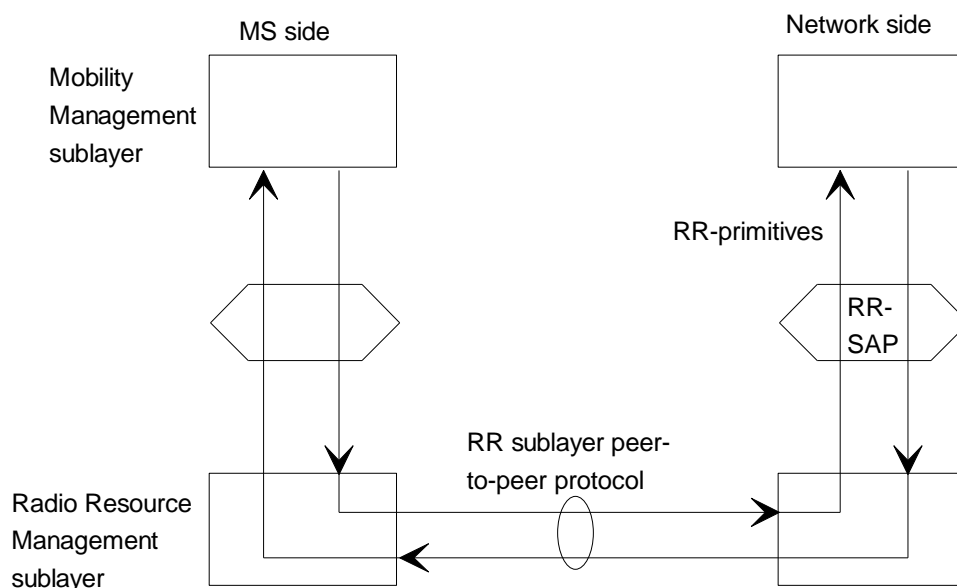
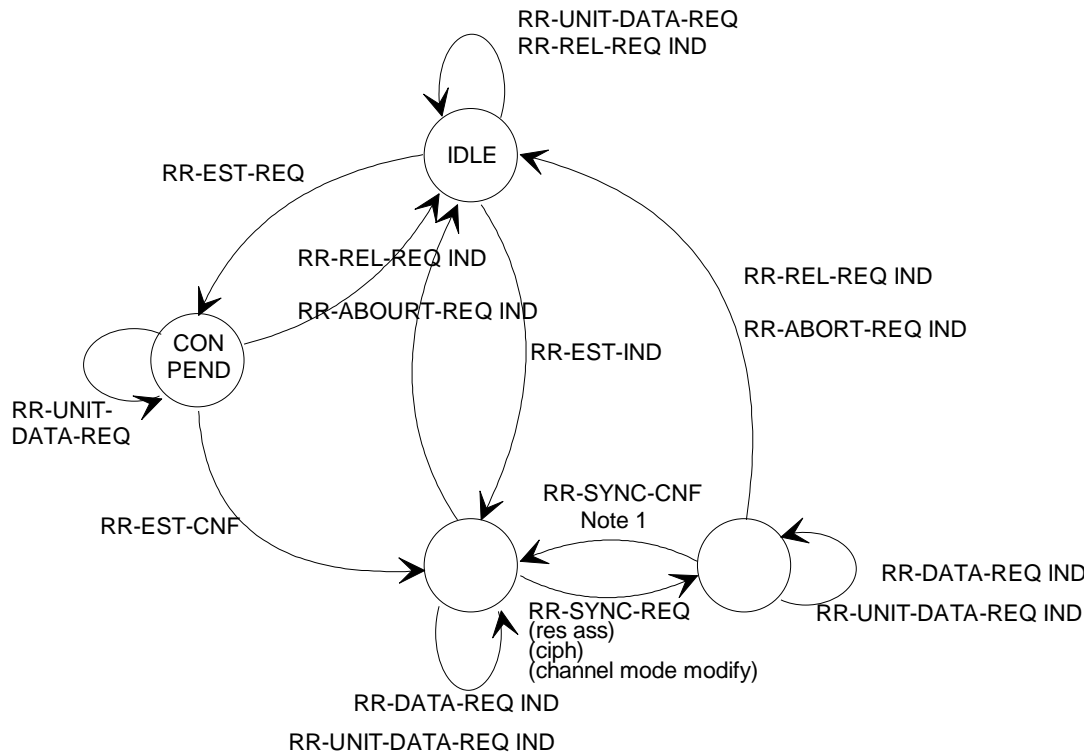


Figure 10.1: Services provided at RR-SAP - Network side

#### 10.1.1 Service state diagram

The primitives provided by the Radio Resource Management entity and the transition between permitted states are shown in figure 10.2.



STATES:

- IDLE - No dedicated channel established.
- CONPEND - Connection pending.
- DT1 - Data transfer 1, dedicated channel established.
- DT2 - Data transfer 2, dedicated channel established, ciphering mode set.

Figure 10.2: Service graph of the Radio Resource Management entity - Network side

### 10.1.2 Service primitives

Table 10.1: Primitives and Parameters at the RR-SAP - Network side

PRIMITIVES	PARAMETERS	REFERENCE
RR_EST_REQ	Parameters for the Initial layer 3 message	10.1.2.1
RR_EST_IND	Initial layer 3 message	10.1.2.2
RR_EST_CNF	-	10.1.2.3
RR_REL_REQ	cause	10.1.2.4
RR_REL_IND	cause	10.1.2.5
RR_SYNC_REQ	cause (resource assign, ciphering)	10.1.2.6
RR_SYNC_CNF	cause (resource assign, ciphering)	10.1.2.7
RR_DATA_REQ	Layer 3 message	10.1.2.8
RR_DATA_IND	Layer 3 message	10.1.2.9
RR_UNIT_DATA_REQ	Layer 3 message	10.1.2.10
RR_UNIT_DATA_IND	Layer 3 message	10.1.2.11
RR_ABORT_REQ	cause	10.1.2.12
RR_ABORT_IND	cause	10.1.2.13

#### 10.1.2.1 RR\_EST\_REQ

Request used by the Mobility Management entity to request establishment of control channel connections.

### 10.1.2.2 RR\_EST\_IND

Indication to the Mobility Management entity that the establishment of control channel connections has been done.

### 10.1.2.3 RR\_EST\_CNF

Confirmation used by RR to confirm the establishment of a requested control channel connection.

### 10.1.2.4 RR\_REL\_REQ

Request used by the Mobility Management to release a control channel connection.

### 10.1.2.5 RR\_REL\_IND

Indication from RR to MM that the main signalling link has been released.

### 10.1.2.6 RR\_SYNC\_REQ

Request used by the Mobility Management entity for synchronization with the RR protocol.

### 10.1.2.7 RR\_SYNC\_CNF

Confirmation used by RR that the requested synchronization is done.

### 10.1.2.8 RR\_DATA\_REQ

Request used by the Mobility Management entity for acknowledged control-data transmission.

### 10.1.2.9 RR\_DATA\_IND

Indication used by RR to transfer received control-data, which should be acknowledged, to the Mobility Management entity.

### 10.1.2.10 RR\_UNIT\_DATA\_REQ

Request used by the Mobility Management entity for unacknowledged control-data transmission.

### 10.1.2.11 RR\_UNIT\_DATA\_IND

Indication used by RR to transfer received control-data, which should not be acknowledged, to the Mobility Management entity.

### 10.1.2.12 RR\_ABORT\_REQ

Request of the abandon of the RR connection.

### 10.1.2.13 RR\_ABORT\_IND

Indication that a radio link failure has occurred.

## 10.2 Services provided by the Mobility Management entity

The Mobility Management (MM) sublayer provides services to the Call Control (CC) entity, the Supplementary Service Support (SS) entity, the Location Services (LCS) (for type A LMU) and the Short Message Service Support (SMS) entity.

The Mobility Management services primitives are recognized by the MMCC, MMSS, MMLCS and MMSMS prefix.

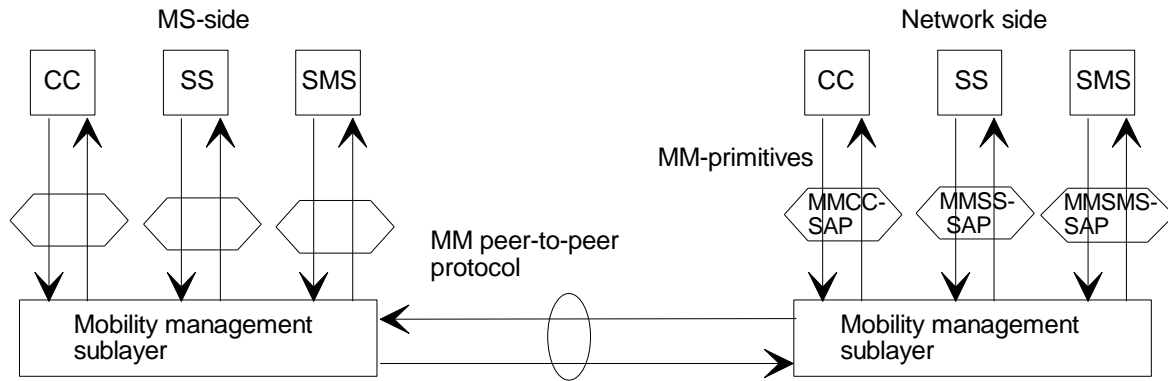
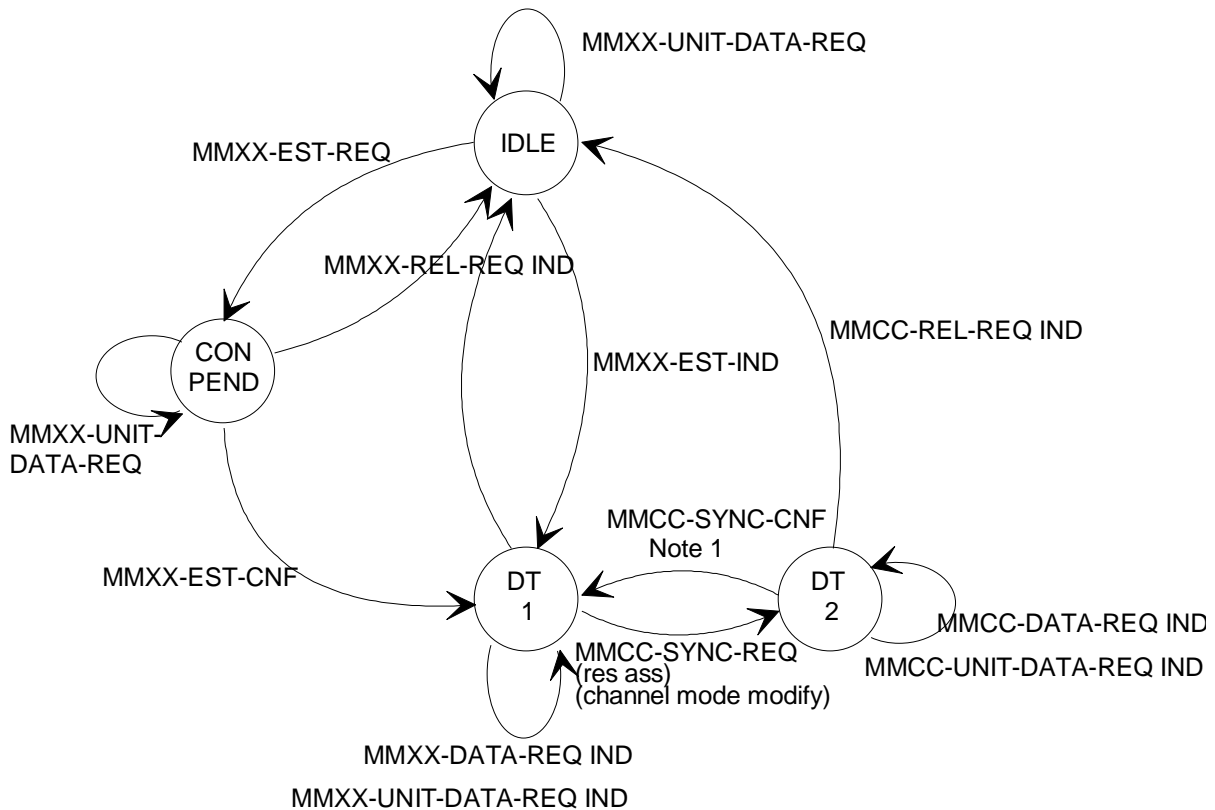


Figure 10.3: Services provided at MMCC-SAP, MMSS-SAP, MMLCS-SAP, MMSMS-SAP - Network side

(Note: Figure 10.3 shall be updated to include the new LCS PD in the same manner as for the other PDs)

### 10.2.1 Service state diagram

The primitives provided by the Mobility Management entity towards Call Control, Short Messages Service Support Location Services (for type A LMU) and call independent Supplementary Services Support as well as the transition between permitted states are illustrated in figure 10.4.



NOTE 1: the parameters in RR\_SYNC\_CNF must correspond to the parameter in RR\_SYNC\_REQ.

NOTE 2: MMCC-primitives only at MMCC-SAP.

NOTE 3: The prefix MMXX is used for substitution of MMCC, MMSS, MMLCS (for type A LMU) or MMSMS.

Figure 10.4: Service graph of the Mobility Management entity, towards Call Control - Network side

## 10.2.2 Service primitives

**Table 10.2: Primitives and Parameters at MMCC-SAP, MMSS-SAP, MMSMS-SAP - Network side**

PRIMITIVES	PARAMETERS	REFERENCE
MMXX_EST_REQ (see note 1)	Mobile ID	10.2.2.1
MMXX_EST_IND (see note 1)	First CM message	10.2.2.2
MMXX_EST_CNF (see note 1)	-	10.2.2.3
MMXX_REL_REQ (see note 1)	cause	10.2.2.4
MMXX_REL_IND (see note 1)	cause	10.2.2.5
MMXX_DATA_REQ (see note 1)	Layer 3 message	10.2.2.6
MMXX_DATA_IND (see note 1)	Layer 3 message	10.2.2.7
MMXX_UNIT_DATA_REQ (see note 1)	Layer 3 message	10.2.2.8
MMXX_UNIT_DATA_IND (see note 1)	Layer 3 message	10.2.2.9
MMCC_SYNC_REQ (see note 2)	cause (resource assign)	10.2.2.10
MMCC_SYNC_CNF (see note 2)	cause (resource assign)	10.2.2.11
NOTE 1: MMXX is used as substitution for MMCC, MMSS, MMLCS (for type A LMU) or MMSMS.		
NOTE 2: Only at MMCC-SAP.		

### 10.2.2.1 MMXX\_EST\_REQ

Request by CC, SS, LCS (for type A LMU) and SMS respectively, for the establishment of a MM connection.

### 10.2.2.2 MMXX\_EST\_IND

Indication by the MM sublayer that a MM connection is established.

### 10.2.2.3 MMXX\_EST\_CNF

Confirmation of the MM connection establishment by the MM sublayer.

### 10.2.2.4 MMXX\_REL\_REQ

Request by CC, SS, LCS (for type A LMU) or SMS respectively, for the release of the MM connection.

### 10.2.2.5 MMXX\_REL\_IND

Indication by the MM sublayer that a MM connection has been released.

### 10.2.2.6 MMXX\_DATA\_REQ

Request by the CC, SS, LCS (for type A LMU) or SMS entities for acknowledged control-data transmission.

### 10.2.2.7 MMXX\_DATA\_IND

Indication used by MM to transfer the received acknowledged control-data to the CC, SS, LCS (for type A LMU) or SMS entities.

### 10.2.2.8 MMXX\_UNIT\_DATA\_REQ

Request used by the CC, SS, LCS (for type A LMU) or SMS entities for unacknowledged control-data transmission.

### 10.2.2.9 MMXX\_UNIT\_DATA\_IND

Indication used by MM to transfer the received unacknowledged control-data to the CC, SS, LCS (for type A LMU) or SMS entities.

### 10.2.2.10 MMCC\_SYNC\_REQ

Request used by the CC entity to synchronize with the MM entity (resource assign).

### 10.2.2.11 MMCC\_SYNC\_CNF

Confirmation used by the MM to inform the CC entity that synchronization is completed (resource assign).

## 10.3 Services provided by radio resource management entity for GPRS services

This section is informative, the service primitives are defined in GSM 04.60 [10]. They are included here to provide a complete overview of the radio interface protocol architecture.

### 10.3.1 Service primitives for GRR-SAP

**Table 10.3.1 Primitives and Parameters at GRR-SAP - network side**

PRIMITIVE	PARAMETER (message, info elements of message, other parameters)	REFERENCE
GRR-DATA-REQ	LLC PDU, TLLI, CI, DRX, MS CLM, QoS, Priority	10.3.1.1
GRR-DATA-IND	LLC PDU, TLLI, CI	10.3.1.2
GRR-UNITDATA-REQ	LLC PDU, TLLI, CI, DRX, MS CLM, QoS, Priority	10.3.1.3
GRR-UNITDATA-IND	LLC PDU, TLLI, CI	10.3.1.4
GRR-STATUS-IND	TLLI, cause	10.3.1.5

#### 10.3.1.1 GRR-DATA-REQ

Request used by the LLC layer for acknowledged data transmission with a certain priority.

#### 10.3.1.2 GRR-DATA-IND

Indication used by RR to transfer received data, which shall be acknowledged, to the LLC layer.

#### 10.3.1.3 GRR-UNITDATA-REQ

Request used by the LLC layer for unacknowledged data transmission with a certain priority.

#### 10.3.1.4 GRR-UNITDATA-IND

Indication used by RR to transfer received data, which shall not be acknowledged, to the LLC layer

#### 10.3.1.5 GRR-STATUS-IND

Indication to upper layers that an error has occurred on the radio interface. The cause for the failure is indicated

## 10.3.2 Service primitives for GMMRR-SAP

**Table 10.3.2 Primitives and Parameters at GMMRR-SAP - network side**

PRIMITIVE	PARAMETER (message, info elements of message, other parameters)	REFERENCE
GMMRR-PAGE-REQ	TLLI, IMSI, CI or CI-list or RAI, priority	10.3.2.1

### 10.3.2.1 GMMRR-PAGE-REQ

Request by GMM to send a RR-paging message to the mobile station.

## 10.4 Services provided by the LLC entity for GPRS services

### 10.4.1 Service primitives for LLGMM-SAP

**Table 10.4.1 Primitives and Parameters at GRR-SAP - network side**

PRIMITIVE	PARAMETER (message, info elements of message, other parameters)	REFERENCE
LLGMM-ASSIGN-REQ	newTLLI, oldTLLI, Kc, Algorithm	10.4.1.1
LLGMM-TRIGGER-IND	TLLI	10.4.1.2
LLGMM-SUSPEND-REQ	TLLI, page	10.4.1.3
LLGMM-RESUME-REQ	TLLI	10.4.1.4
LLGMM-PAGE-IND	TLLI	10.4.1.5
LLGMM-PAGE-RESP-IND	TLLI	10.4.1.6
LLGMM-WINDOW-REQ	TLLI	10.4.1.7
LLGMM-WINDOW-CNF	actual LLC's N(R) per SAP	10.4.1.8
LL-UNITDATA-REQ	TLLI, SMM-PDU, protect, cipher	10.4.1.9
LL-UNITDATA-IND	TLLI, SMM-PDU, cipher	10.4.1.10
LLGMM-STATUS-IND	TLLI, cause	10.4.1.11

#### 10.4.1.1 LLGMM-ASSIGN-REQ

A new TLLI and/or a ciphering key and/or a ciphering algorithm is assigned to the LL sublayer. Also an old TLLI can be unassigned.

#### 10.4.1.2 LLGMM-TRIGGER-IND

An LLC frame has been received from the mobile station.

### 10.4.1.3 LLGMM-SUSPEND-REQ

All LLC links will cease sending PDUs. The parameter page indicates that data shall be sent if available and therefore paging shall be needed. Or the cause indicates that data shall not be sent until a RESUME-REQ is received.

### 10.4.1.4 LLGMM-RESUME-REQ

Normal LLC frame sending and reception is possible again.

### 10.4.1.5 LLGMM-WINDOW-REQ

Request for the actual LLC's N(R)s.

### 10.4.1.6 LLGMM-WINDOW-CNF

The actual LLC's V(R)s for each LLC link in ABM mode are transferred to SMM.

### 10.4.1.7 LLGMM-PAGE-IND

Requires to send a paging message to the mobile station.

### 10.4.1.8 LLGMM-PAGE-RESP-IND

A paging response has been received from the mobile

### 10.4.1.9 LL-UNITDATA-REQ

Request to send a SMM message in unacknowledged mode to the peer entity.

### 10.4.1.10 LL-UNITDATA-IND

A SMM message in unacknowledged mode has been received from the peer entity.

### 10.4.1.11 LLGMM-STATUS-IND

Indication used by LLC to transfer lower layer failures to the GMM sublayer.

## 10.4.2 Service primitives for LLSMS-SAP

**Table 10.4.2; Primitives and Parameters at LLSMS-SAP - network side**

PRIMITIVE	PARAMETER (message, info elements of message, other parameters)	REFERENCE
LL-UNITDATA-REQ	TLLI, SMS-CP-PDU, protect, cipher	10.4.2.1
LL-UNITDATA-IND	TLLI, SMS-CP-PDU	10.4.2.2

### 10.4.2.1 LL-UNITDATA-REQ

An LLC UI frame will be sent to the peer entity.

### 10.4.2.2 LL-UNITDATA-IND

An LLC UI frame has been received from the peer entity.



## 10.5 Services provided by the GMM for GPRS services

### 10.5.1 Service primitives for GMMSM-SAP

**Table 10.5.1: Primitives and Parameters at GMMSM-SAP - network side**

PRIMITIVE	PARAMETER (message, info elements of message, other parameters)	REFERENCE
GMMSM-RELEASE-IND	-	10.5.1.1
GMMSM-UNITDATA-REQ	SM-PDU	10.5.1.2
GMMSM-UNITDATA-IND	SM-PDU	10.5.1.3

#### 10.5.1.1 GMMSM-RELEASE-IND

The GPRS mobility management informs the session management that the MS has been GPRS detached, e.g. by timer expiry, and therefore the PDP contexts are not valid anymore.

#### 10.5.1.2 GMMSM-UNITDATA-REQ

The GMM is requested to forward a SM PDU to LLC in order to send it in unacknowledged mode to the peer entity.

#### 10.5.1.3 GMMSM-UNITDATA-IND

The GMM forwards a SM PDU, which has been received in unacknowledged mode via LLC from the peer entity.

## 10.6 Services provided by the Radio Resource Management entity for CTS on the fixed part

In addition to services described in 10.1, the CTS Radio Resource Management (CTS-RR) inside the RR sublayer provides services to the CTS Mobility Management entity (CTS-MM).

The CTS-RR services are used for:

- alive check;
- hunting;
- group alerting.

The CTS Radio Resource Management services are represented by the CTS-RR service primitives.

### 10.6.1 Service primitives

**Table 10.6: Primitives and Parameters at the RR-SAP – Fixed part side**

PRIMITIVES	PARAMETERS	REFERENCE
RR_CTS_ALIVE_CHECK_REQ	CTSMSI	10.6.1.1
RR_CTS_ALIVE_CHECK_IND	Cause	10.6.1.2
RR_CTS_HUNTING_REQ	-	10.6.1.3
RR_CTS_GROUP_ALERTING_REQ	CTSMSI, display	10.6.1.4

### 10.6.1.1 RR\_CTS\_ALIVE\_CHECK\_REQ

Request used by the CTS Mobility Management entity to request an alive check.

### 10.6.1.2 RR\_CTS\_ALIVE\_CHECK\_IND

Indication to the CTS Mobility Management entity on the results of the alive check.

### 10.6.1.3 RR\_CTS\_HUNTING\_REQ

Request to hunt the mobiles.

### 10.6.1.4 RR\_CTS\_GROUP\_ALERTING\_REQ

Request to alert a group of mobiles.

---

## 11 L3 Messages

This clause specifies the generic methods used in the layer 3 protocol specifications to describe messages. It defines in particular a generic message structure, that of the "standard L3 messages". Not all messages in layer 3 protocols follow this structure, but many do, and this section specifies how to interpret the standard description.

This clause also addresses basic aspects of the handling of messages received but not compliant with the allowed structure. In most cases, only the conditions that lead to the diagnosis of an error are described. The reaction of an entity receiving a message leading to such a diagnosis is in general specified for each protocol in the relevant protocol specification.

### 11.1 General

#### 11.1.1 Messages

For all concerned protocols, concrete messages are bit strings of variable length, formally a succession of a finite, possibly null, number of bits (i.e., elements of the set {"0", "1"}), with a beginning and an end.

The services provided by lower layers includes the transmission of such bit strings.

Considered as messages, these bit strings follow some structure (the syntax), enabling to organise bits in information pieces of a different meaning level.

The term *message* is used as well for a concrete message (i.e., a bit-string, as defined by the giving of all its bits, in practice appearing at one point of time in a concrete dialog), as for a class of concrete messages sharing a common structure. A concrete message is an instance of the corresponding class of messages. Message classes can be described as sets of potential bit strings, and of a common structure, enabling in particular to identify parts meaningful for the co-operation functions the protocol supports.

In general, in the rest of the clause as in the protocol specifications, the term *message* will be used to refer to the class. It may be used, when the context prevents ambiguity, to refer to a message instance (e.g., a received is usually a message instance). In the rest of this clause, the term *message instance* will be used when needed to refer unambiguously to specific concrete message, i.e., to a specific bit string.

A message (message class) can be described directly as a set of bit strings, using the formal notation described in Annex B.

A message can also be described as a standard L3 message, in which case the interpretation of the message description in term of a set of bit strings is specified in the next sub-clauses.

In all cases, structuring messages is based on the underlying bit string. Thus, the following terms are used :

a *part* of a message instance is a sub-string of the corresponding string ; a part of a message (as a class) is described by a definition applicable to all instances ; a part of a message then is both a structural attribute of the message as a class, and a set of sub-strings, composed of the sub-strings obtained by applying the definition to each possible instance ; for instance, « the first octet » of a message instance is defined from the moment its length is greater than 8, and is the sub-string composed of the first 8 bits of the message instance ; the « first octet » of a message as a class is the structural definition given above, and the set of all 8-bit octet strings that can be obtained as the first octet of one instance of the class.

'part A *follows* part B' means that in the message the sub-string corresponding to part B is concatenated with the sub-string of part B ;

the *length* of a message instance, or of part of message instance, is the number of bits of the corresponding sub string ; rigorously speaking, a message as a class (or a part seen as a class) has a length only if all the corresponding instances have the same length ; by extension, sentences such as « a message as a length in the range so and so » means that the length of an instances of the class always fall in the range ;

## 11.1.2 Octets

In many places, a message is described as a succession of octets. An octet is generally a succession of 8 bits. Unless otherwise indicated, the term octet is used more restrictively to refer to a part of message, defined when considering a message as a succession of octets, e.g., the first 8 bits of a message, or the 17<sup>th</sup> to the 23<sup>rd</sup>, form an octet, but not the second bit to the 9<sup>th</sup>.

Unless specified otherwise, the numbering conventions are the following :

Octets in a message or in a part are numbered from 1 onward, starting at the beginning of the bit string. This numbering can be strictly applied only for message instances, and for the first part of a message structurally identical for all instances.

Bits in octets are numbered from 8 down to 1, starting at the beginning of the octet.

When represented as tables showing the different bit positions, octets are presented in the natural occidental order, i.e., from the top of a page downward. Bits in octets are presented with the first bit on the left of the page.

## 11.1.3 Integer

In many places, message parts are described as encoding integers. Two generic encoding are defined in this sub-clause.

### 11.1.3.1 Binary

A message part is said to encode in binary an integer to indicate that concrete strings are mapped, for some usage, on the set of non signed integers with the following rule :

Let  $k$  denote the length of the bit string, and let  $b(i)$  denote an integer of value 0 if the  $i^{\text{th}}$  bit in the string is "0", and 1 otherwise. The encoded integer  $n$  respects the equation :

$$n = \sum_{i=1 \text{ to } k} b(i)2^{k-i-1}$$

### 11.1.3.2 2-complement binary

A message part is said to encode in 2-complement binary an integer to indicate that concrete strings are mapped, for some usage, on the set of signed integers with the following rule :

Let  $k$  denote the length of the bit string, and let  $b(i)$  denote an integer of value 0 if the  $i^{\text{th}}$  bit in the string is "0", and 1 otherwise. The encoded integer  $n$  respects the equation :

$$\text{if } b(1) = 0 \text{ then } n = \sum_{i=1tok} b(i)2^{k-i-1}$$

$$\text{else } n = \sum_{i=1tok} b(i)2^{k-i-1} - 2^k$$

### 11.1.4 Spare parts

In some cases the specification is that which message instances can be accepted by a receiver comprise more than the legal message instances that can be sent. One example of this is the notion of spare bit. A spare bit has to send as the value indicated in the specification (typically 0), but can be accepted as a 0 or a 1 by the receiver without error diagnosis. A spare field is a field composed entirely of spare bits.

## 11.2 Standard L3 messages

### 11.2.1 Components of a standard L3 message

A standard L3 message consists of an imperative part, itself composed of a header and the rest of imperative part, followed by a non-imperative part. Both the non-header part of the imperative part and the non-imperative part are composed of successive parts referred to as standard information elements.

#### 11.2.1.1 Format of standard information elements

A standard IE may have the following parts, in that order:

- an information element identifier (IEI);
- a length indicator (LI);
- a value part.

A standard IE has one of the formats shown in table 11.1:

**Table 11.1: Formats of information elements**

Format	Meaning	IEI present	LI present	Value part present
T	Type only	yes	no	no
V	Value only	no	no	yes
TV	Type and Value	yes	no	yes
LV	Length and Value	no	yes	yes
TLV	Type, Length and Value	yes	yes	yes

Some IEs may appear in the structure, but not in all instances of messages. An IE is then said to be present or not present in the message instance. If an IE is not present in a message instance, none of the three parts is present. Otherwise, parts must be present according to the IE format.

In the message structure, an IE that is allowed not to be present in all message instances is said not to be mandatory. Other IEs are said to be mandatory.

#### 11.2.1.1.1 Information element type and value part

Every standard IE has an information element type which determines the values possible for the value part of the IE, and the basic meaning of the information. The information element type describes only the value part. Standard IEs of the same information element type may appear with different formats. The format used for a given standard IE in a given message is specified within the description of the message.

The value part of a standard IE either consists of a half octet or one or more octets; the value part of a standard IE with format LV or TLV consists of an integral number of octets, between 0 and 255 inclusive ; it then may be empty, i.e., consist of zero octets; if it consists of a half octet and has format TV, its IEI consists of a half octet, too. The value part of a standard IE may be further structured into parts, called fields.

11.2.1.1.2 Length indicator

When present, the LI of a standard IE consists of one octet. It contains the binary encoding of the number of octets of the IE value part. The length indicator of a standard IE with empty value part indicates 0 octets. Standard IE of an information element type such that the possible values may have different values must be formatted with a length field, i.e., LV or TLV.

11.2.1.1.3 Information element identifier

When present, the IEI of a standard IE consists of a half octet or one octet. A standard IE with IEI consisting of a half octet has format TV, and its value part consists of a half octet. The value of the IEI depends on the standard IE, not on its information element type. The IEI, if any, of a given standard IE in a given message is specified within the description of the message. In some protocol specifications, default IEI values can be indicated. They are to be used if not indicated in the message specification. Non mandatory standard IE in a given message, i.e., IE which may be not be present (formally, for which the null string is acceptable in the message), must be formatted with an IEI, i.e., with format T, TV or TLV.

11.2.1.1.4 Categories of IEs; order of occurrence of IEI, LI, and value part

Totally four categories of standard information elements are defined:

- information elements of format V or TV with value part consisting of 1/2 octet (type 1);
- information elements of format T with value part consisting of 0 octets (type 2);
- information elements of format V or TV with value part that has fixed length of at least one octet (type 3);
- information elements of format TLV or LV with value part consisting of zero, one or more octets (type 4);

Type 1 standard information elements of format V provide the value in bit positions 8, 7, 6, 5 of an octet (see figure 11.1) or bits 4, 3, 2, 1 of an octet (see figure 11.2).

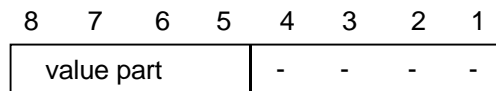


Figure 11.1: Type 1 IE of format V

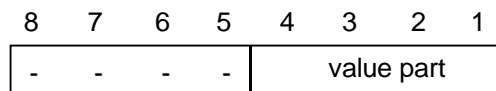


Figure 11.2: Type 1 IE of format V

Type 1 standard information elements of format TV have an IEI of a half octet length; they provide the IEI in bit positions 8, 7, 6, 5 of an octet and the value part in bit positions 4, 3, 2, 1 of the same octet, see figure 11.3.

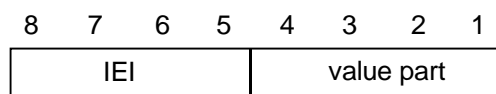
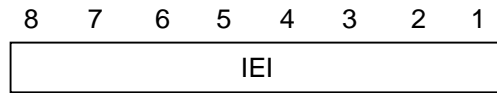


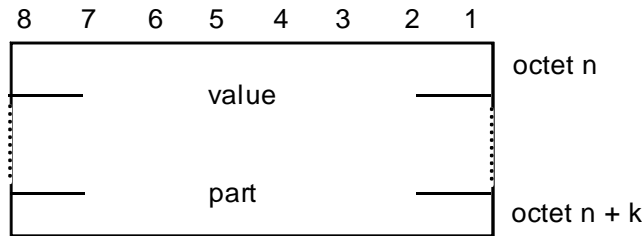
Figure 11.3: Type 1 IE of format TV

A type 2 standard IE has format T; its IEI consists of one octet, its value part is empty, see figure 11.4.

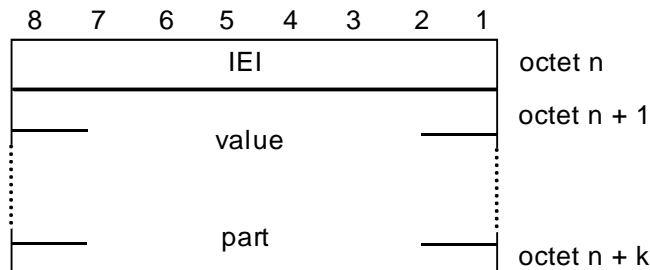


**Figure 11.4: Type 2 IE**

A type 3 standard information element has format V or TV; if it has format TV, its IEI consists of one octet and precedes the value part in the IE. The value part consists of at least one octet. See figure 11.5 and figure 11.6.

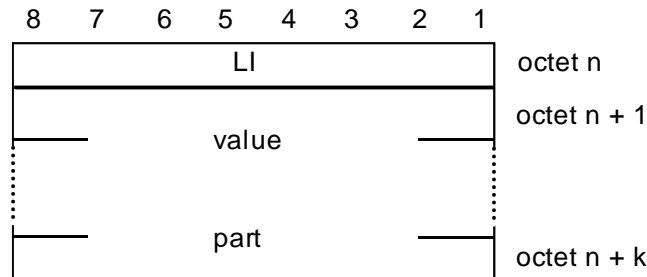


**Figure 11.5: Type 3 IE of format V (k = 0, 1, 2, ...)**

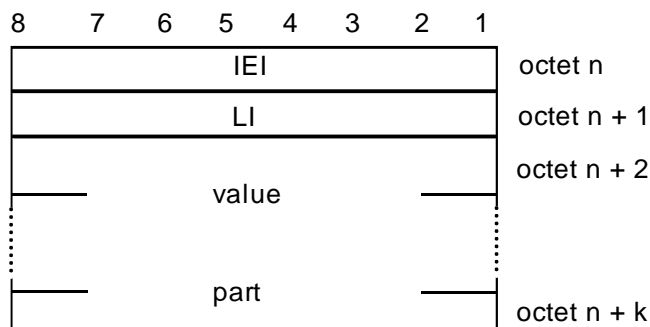


**Figure 11.6: Type 3 IE of format TV (k = 1, 2, ...)**

A type 4 standard information element has format LV or TLV. Its LI precedes the value part, which consists of zero, one, or more octets; if present, its IEI has one octet length and precedes the LI. See figure 11.7 and figure 11.8.



**Figure 11.7: Type 4 IE of format LV (k = 0, 1, 2, ...)**



**Figure 11.8: Type 4 IE of format TLV (k = 1, 2, ...)**

## 11.2.2 Description methods for IE structure

Standard IEs can be further structured in parts called fields. Two description methods are recommended and described hereafter.

### 11.2.2.1 Tables

According to this description method, the IE is presented in its maximum format, i.e., T, TV or TLV, in a picture representing the bits in a table, each line representing an octet. Bits appear in the occidental order, i.e., from left of the page to right of the page, and from top of the page to bottom of the page.

Boxes so delimited contains typically the field name, possibly an indication of which bits in the field are in the box, and possibly a value (e.g., for spare bits).

A specific method can be used in the IE description to describe a branching structure, i.e., a structure variable according to the value of particular fields in the IE. This design is unusual outside type 4 IEs, and as, a design rule, should be used only in type 4 IEs.

- a) The octet number of an octet within the IE is defined typically in the table. It consists of a positive integer, possibly of an additional letter, and possibly of an additional asterisk, see clause f). The positive integer identifies one octet or a group of octets.
- b) Each octet group is a self contained entity. The internal structure of an octet group may be defined in alternative ways.
- c) An octet group is formed by using some extension mechanism. The preferred extension mechanism is to extend an octet (N) through the next octet(s) (Na, Nb, etc.) by using bit 8 in each octet as an extension bit.

The bit value "0" indicates that the octet group continues through to the next octet. The bit value "1" indicates that this octet is the last octet of the group. If one octet (Nb) is present, the preceding octets (N and Na) shall also be present.

In the format descriptions appearing in section 10.5.1 to 10.5.4, bit 8 is marked "0/1 ext" if another octet follows. Bit 8 is marked "1 ext" if this is the last octet in the extension domain.

Additional octets may be defined in later versions of the protocols ("1 ext" changed to "0/1 ext") and equipments shall be prepared to receive such additional octets; the contents of these octets shall be ignored. However the length indicated in sections 9 and 10 only takes into account this version of the protocols.

- d) In addition to the extension mechanism defined above, an octet (N) may be extended through the next octet(s) (N+1, N+2 etc.) by indications in bits 7-1 (of octet N).
- e) The mechanisms in c) and d) may be combined.
- f) Optional octets are marked with asterisks (\*). As a design rule, the presence of absence of an optional octet should be determinable from information in the IE and preceding the optional octet. Care should be taken not to introduce ambiguities with optional octets.

#### 11.2.2.1.1 Compact notation

The compact notation described in Annex B can be used to describe the value part of a standard IE. This method is recommended for complex structures, or for a branching structure not respecting octet boundaries.

## 11.2.3 Imperative part of a standard L3 message

The imperative part of a standard L3 message is composed a header possibly followed by mandatory standard IEs having the format V or LV.

### 11.2.3.1 Header

The header of a standard L3 message is composed of two octets, and structured in three main parts, the protocol discriminator (1/2 octet), a message type octet, and a half octet used in some cases as a Transaction Identifier, in some other cases as a sub-protocol discriminator, and called skip indicator otherwise.

#### 11.2.3.1.1 Protocol discriminator

Bits 1 to 4 of the first octet of a standard L3 message contain the protocol discriminator (PD) information element. The PD identifies the L3 protocol to which the standard layer 3 message belongs. The correspondence between L3 protocols and PDs is one-to-one.

For future evolution an extension mechanism is foreseen which allows the use of protocol discriminators with one octet length, where bits 4 to one are coded as 1 1 1 0. Messages of such protocols may not be standard L3 messages. In particular, the rest of the header may not respect the structure described in this sub-clause.

The PD can take the following values:

**Table 11.2: Protocol discriminator values**

bits	4 3 2 1	
0 0 0 0		group call control
0 0 0 1		broadcast call control
0 0 1 0		PDSS1
0 0 1 1		call control; call related SS messages
0 1 0 0		PDSS2
0 1 0 1		mobility management messages
0 1 1 0		radio resources management messages
1 0 0 0		GPRS mobility management messages
1 0 0 1		SMS messages
1 0 1 0		GPRS session management messages
1 0 1 1		non call related SS messages
1 1 0 0		Location services
1 1 1 0		reserved for extension of the PD to one octet length
1 1 1 1		reserved for tests procedures described in GSM 11.10

If the network receives, on a SAP where it expects standard L3 messages, a message with a protocol discriminator different from those specified in table 11.2, the network may ignore the message or initiate the channel release procedure defined in GSM 04.08.

If the Mobile Station receives, on a SAP where it expects standard L3 messages, a standard L3 message with a protocol discriminator different from those specified in table 11.2, or for a protocol that it does not support, the Mobile Station shall ignore the message.

#### 11.2.3.1.2 Skip indicator

Bits 5 to 8 of octet 1 of a standard L3 message may be used differently, depending on the protocol and the SAP. The use of this half-octet is consistent for a given PD and SAP. One possibility is that this half-octet contains the skip indicator. Unless otherwise specified in the protocol, the skip indicator IE is a spare field.

#### 11.2.3.1.3 Transaction identifier

A L3 protocol may define that bits 5 to 8 of octet 1 of a standard L3 message of the protocol contains the transaction identifier (TI). The TI allows to distinguish up to 16 different bi-directional messages flows for a given PD and a given SAP. Such a message flow is called a transaction.

The TI IE is coded as shown in figure 11.9 and table 11.3. It is composed of the TI value and the TI flag.

The TI value and the TI flag occupy bits 5 - 7 and bit 8 of the first octet respectively.



Transactions are dynamically created, and their TI value is assigned at creation time. TI values are assigned by the side of the interface initiating a transaction. At the beginning of a transaction a free TI value (i.e., a value not yet used for the given PD, the given SAP, and with the given initiator) is chosen and assigned to this transaction. It then remains fixed for the lifetime of the transaction. After a transaction ends, the associated TI value is free and may be reassigned to a later transaction.

Two identical TI values may be used when each value pertains to a transaction initiated by the different sides of the interface. In this case the TI flag shall avoid ambiguity. The transaction identifier flag can take the values "0" or "1". The TI flag is used to identify which side of the interface initiated the transaction. A message has a TI flag set to "0" when it belongs to transaction initiated by its sender, and to "1" otherwise.

Hence the TI flag identifies who allocated the TI value for this transaction and the only purpose of the TI flag is to resolve simultaneous attempts to allocate the same TI value.

The TI may in future evolutions of the L3 protocols be extended by using a combination of bits in the TI value field that is specified as "reserved for future extension" in table 11.3. In the present version, messages received on a SAP where standard L3 messages are expected and with a TI of TI value 111 may be ignored.

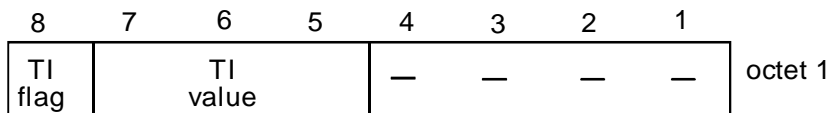


Figure 11.9: Transaction identifier

Table 11.3. Transaction identifier

TI flag (octet 1)	
Bit	
8	
0	The message is sent from the side that originates the TI
1	The message is sent to the side that originates the TI
TI value (octet 1)	
Bits	
7 6 5	
0 0 0	TI value 0
0 0 1	- - 1
0 1 0	- - 2
0 1 1	- - 3
1 0 0	- - 4
1 0 1	- - 5
1 1 0	- - 6
1 1 1	Reserved for future extension.

11.2.3.1.4 Sub-protocol discriminator

A L3 protocol may define that bits 5 to 8 of octet 1 of a standard L3 message of the protocol contains the sub-protocol discriminator (SPD). The SPD allows to distinguish between different protocols inside one sublayer.

Table 11.4: Sub-Protocol discriminator values

bits	8 7 6 5	
0 0 0 0		Value used by the Skip Indicator (see 11.2.3.1.2)
0 0 0 1		CTS sub-protocol
0 0 1 0		\
To		} all other values are reserved
1 1 1 1		/

### 11.2.3.2 Message type octet

The message type octet is the second in a standard L3 message.

When a standard L3 message is expected, and a message is received that is less than 16 bit long, that message shall be ignored.

The message type IE is coded as shown in figure 11.10.

Bit 8 is encoded as "0"; value "1" is reserved for possible future use as an extension bit. A protocol entity expecting a standard L3 message, and receiving a message containing bit 8 of octet 2 encoded as "1" shall diagnose a "message not defined for the PD" error and treat the message accordingly.

In messages sent using the transmission functionality provided by the RR layer to upper layers, and sent from the mobile station to the network, bit 7 of octet 2 is used by the RR protocol.

In all other standard layer 3 messages bit 7 is set to 0. A protocol entity expecting a standard L3 message, and not using the transmission functionality provided by the RR layer, and receiving a message containing bit 7 of octet 2 encoded as 1 shall diagnose a "message not defined for the PD" error and treat the message accordingly.

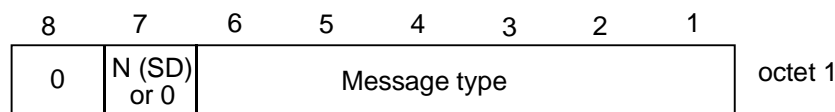


Figure 11.10: Message type IE

Bit 1 to 6 of octet 2 of standard L3 messages contain the message type.

The message type determines the function of a message within a protocol in a given direction and for a given lower layer SAP. The meaning of the message type is therefore dependent on the protocol (the same value may have different meanings in different protocols), the direction (the same value may have different meanings in the same protocol, when sent from the Mobile Station to the network and when sent from the network to the Mobile Station) and the lower layer SAP (the same value may have different meanings, e.g., whether the message was sent on the SACCH or on the main DCCH).

Each protocol defines a list of allowed message types for each relevant SAP. A message received analysed as a standard L3 message, and with a message type not in the corresponding list leads to the diagnosis "message not defined for the PD". Some message types may correspond to a function not implemented by the receiver. They are then said to be non implemented by the receiver.

The reaction of a protocol entity expecting a standard L3 message and receiving a message with message type not defined for the PD or not implemented by the receiver and the reception conditions is defined in the relevant protocol specification. As a general rule, a protocol specification should not force the receiver to analyse the message further.

### 11.2.3.3 Standard information elements of the imperative part

The message type octet of a standard L3 message may be followed by mandatory standard IEs having the format V or LV as specified in the message description in the relevant protocol specification.

As a design rule, octet boundaries must be respected. This implies that half-octet standard IEs (i.e., V formatted type 1 standard IEs) must appear by pair.

If message is received as a standard L3 message, and that is too short to contain the complete imperative part as specified in the relevant protocol specification, an imperative message part error is diagnosed. (The same error may be diagnosed at detection of certain contents of the imperative part of a message; this is defined in the relevant protocol specification.) The treatment of an imperative message part error is defined in the relevant protocol specification.

### 11.2.4 Non-imperative part of a standard L3 message

The imperative part of a standard L3 message is followed by the (possibly empty) non-imperative part. The relevant protocol specification defines where the imperative part of a standard L3 message ends. The non-imperative part of a standard L3 message is composed of (zero, one, or several) standard IEs having the format T, TV, or TLV. The receiver of a standard L3 message shall analyse the non imperative part as a succession of standard IEs each containing an IEI, and shall be prepared for the non-imperative part of the message to contain standard IEs that are not specified in the relevant protocol specification.

An IEI may be known in a message or unknown in a message. Each protocol specification lists, for each message (i.e., according to the message type, the direction and the lower layer SAP), the known standard IEs in the non-imperative part.

An IEI that is known in a message designates the IE type of the IE the first part of which the IEI is, as well as the use of the information. Which IE type it designates is specified in the relevant protocol specification. Within a message, different IEIs may designate the same IE type if that is defined in the relevant protocol specification.

Whether the second part of an IE with IEI known in a message is the length or not (in other words, whether the IEI is the first part of an IE formatted as TLV or not) is specified in the relevant protocol specification.

Unless otherwise specified in the protocol specification, the receiver shall assume that IE with unknown IEI are TV formatted type 1, T formatted type 2 or TLV formatted type 4 standard IEs. The IEI of unknown IEs together with, when applicable, the length indicator, enable the receiver to determine the total length of the IE, and then to skip unknown IEs. The receiver shall assume the following rule for IEs with unknown IEI :

Bit 8 of the IEI octet is set to "1" indicates a TV formatted type 1 standard IE or a T formatted type 2 IEs, and to "0" indicates a TLV formatted type 4 IE. Hence, a 1 valued bit 8 indicates that the whole IE is one octet long, and a 0 valued bit 8 indicates that the following octet is a length octet.

As a design rule, it is recommended that IEIs of any TV formatted type 1, T formatted type 2 or TLV formatted type 4 IE follow the rule, even if assumed to be known by all potential receivers.

A message may contain two or more IEs with equal IEI. Two IEs with the same IEI in a same message must have the same format, and, when of type 3, the same length. More generally, care should be taken not to introduce ambiguities by using an IEI for two purposes. Ambiguities appear in particular when two IEs potentially immediately successive have the same IEI but different meanings and when both are non-mandatory. As a recommended design rule, messages should contain a single IE of a given IEI.

Each protocol specification may put specific rules for the order of IEs in the non-imperative part. An IE known in the message, but at a position non compliant with these rules is said to be out of sequence. An out of sequence IE is decoded according to the format, and, when of type 3 the length, as defined in the message for its IEI.

### 11.2.5 Presence requirements of information elements

The relevant protocol specification may define three different presence requirements (M, C, or O) for a standard IE within a given standard L3 message:

- M ("Mandatory") means that the IE shall be included by the sending side, and that the receiver diagnoses a "missing mandatory IE" error when detecting that the IE is not present. An IE belonging to the imperative part of a message has presence requirement M. An IE belonging to the non-imperative part of a message may have presence requirement M;
- C ("Conditional") means:
  - \* that inclusion of the IE by the sender depends on conditions specified in the relevant protocol specification;
  - \* that there are conditions for the receiver to expect that the IE is present and/or conditions for the receiver to expect that the IE is not present in a received message of a given PD, SAP and message type; these conditions depend only on the content of the message itself, and not for instance on the state in which the message was received, or on the receiver characteristics; they are known as static conditions;
  - \* that the receiver detecting that the IE is not present when sufficient static conditions are fulfilled for its presence, shall diagnose a "missing conditional IE" error;
  - \* that the receiver detecting that the IE is present when sufficient static conditions are fulfilled for its non-presence, shall diagnose an "unexpected conditional IE" error.

Only IEs belonging to the non-imperative part of a message may have presence requirement C;

- O ("Optional") means that the receiver shall never diagnose a "missing mandatory IE" error, a "missing conditional IE" error, or an "unexpected conditional IE" error because it detects that the IE is present or that the IE is not present. (There may however be conditions depending on the states, resources, etc. of the receiver to diagnose other errors.) Only IEs belonging to the non-imperative part of a message may have presence requirement O.

Unless otherwise specified the presence of a IE of unknown IEI or of an out of sequence IE shall not lead by itself to an error. An alternative specification is the 'comprehension required' scheme. An IE is encoded as 'comprehension required' if bits 5, 6, 7 and 8 of its IEI are set to zero.. The comprehension required scheme is to be applied if explicitly indicated in the protocol specification. The reaction on the reception of an unknown or out of sequence IE coded as 'comprehension required' is specified in the relevant protocol specification.

### 11.2.6 Description of standard L3 messages

This sub-clause describes a generic description method for standard L3 messages, the tabular description. Protocol specification may follow other methods.

A standard L3 message is described by a table listing the header elements and the standard IEs in the message. For each element is given

- if applicable the IEI, in hexadecimal representation (one digit followed by and hyphen for TV formatted type 1, and two digits for the other cases);
- The name of the IE (this is used in particular for the description of conditional presence rules);
- The type of the information element, with a reference of where the internal structure of the value part is specified;
- The format of the standard IE (T, V, TV, LV or TLV); and
- The length, or the range of lengths, of the whole standard IE, including when applicable the T and L parts.

The list of elements is given in the table in the order they appear in the resulting bit string, with the exception of half-octet elements in the imperative part : half octets in a pair are inverted. This applies in particular for the two first header elements : the protocol discriminator appears first in a table describing a standard L3 message.

### 11.3 Non standard L3 messages

In some protocols, the structure of part or all of the messages might not always follow the standard L3 message structure. As a design rule, this should be consistent for a given protocol, direction and lower layer SAP.

A possibility is to describe the message with the compact notation described in Annex B.

A few consistent structures are found in the present protocol specifications, and are described hereafter.

Other structures can be described directly in the protocol specifications.

### 11.3.1 Case A : BCCH and AGCH/PCH messages

In these cases, the SAP capability is for fixed length messages. The messages are structured as standard L3 messages plus one octet in front, the L2 pseudo length octet, and a rest octet part at the end.

#### 11.3.1.1 L2 Pseudo Length octet

This octet, the L2 pseudo length indicator octet, indicates the length in octets of the subsequent octet string that can be analysed as a standard L3 message .

The octet is structured as follows :

Bits 3 to 8 encodes in binary the L2 pseudo length, i.e., the length of the part to be analysed as a standard L3 message ;

Bit 2 is set to "0" ;

Bit 1 is set to "1".

A receiver expecting a message so structured and receiving a message with bit 1 of octet 1 (i.e., the 8<sup>th</sup> bit of the message) set to "1" and bit 2 of octet 1 (i.e., the 7<sup>th</sup> bit of the message) different from "0", shall abandon the analysis of the message.

A receiver expecting a message so structured and receiving a message with an L2 pseudo length indicator encoding 0 or 1 shall skip the indicated number of octets and not try to analyse the standard L3 message part.

A receiver expecting a message so structured and receiving a L2 pseudo length indicator bigger than what is compatible with the SAP capability shall abandon the analysis of the message.

#### 11.3.1.2 Rest Octets

The part after the part structured as a standard L3 message, and up to the end of the message as constrained by lower layers, is presented as a non standard IE of variable length (sometime indicated as of type 5), the 'rest octets' IE.

The rest octets element may be described by table description, or, preferably, using the compact notation described in Annex B of the present document.

#### 11.3.1.3 Description of a modified standard L3 message

The description can be provided in the same way as a standard L3 message, with in the case of a tabular description one non standard IE at the beginning (of type L2 pseudo length), and one non standard IE at the end.

### 11.3.2 Case B : SACCH messages sent in unacknowledged mode

The messages are structured either as standard L3 messages, or in the so-called short header format. The value of the 8<sup>th</sup> bit (bit 1 of octet 1) of the link layer PDU distinguishes the two cases. In the case of the short header, the L3 message is the same bit string as the link layer PDU, and has a fixed length. The following description includes the 2-bit link layer header.

### 11.3.2.1 The first octet

Bits 1 and 2 are the link layer header. Bit 2 of octet 1 is set to "0", and bit 1 is reserved for the link layer.

A protocol discriminator is the first part of the message (starting bit 8 of octet 1). The protocol discriminator field may have different lengths. The following protocol discriminator is defined :

0 RR

All additional PD defined for this structure shall start by 1. The reception of a message with bit 8 of octet 1 set to 1 when expecting a message structured as defined by this clause shall be diagnosed as an unknown PD, and the message ignored.

As a design rule, a message type field should follow the PD, and of a length such that the PD and the message type fit in the 6 first bits of the message.

### 11.3.2.2 The rest of the message

The rest of the structure is not more constrained.

The preferred description method is the one described in Annex B.

## 11.3.3 Design guidelines for non standard parts

The guidelines in this sub-clause apply to non standard parts, such as rest octets, short header broadcast message or fully non standard L3 messages.

### 11.3.3.1 General

The structure should be as far as possible be such that the analysis can be conducted from beginning to end. In other terms, the conditions determining the syntactic analysis of a part (e.g., tags, lengths) should appear before that part.

The part should be structured as a succession of information elements, each carrying an elementary semantic information. An information element should be composed of (possibly) a tag, than (possibly) a length indicator, then a value part.

Tags can be of fixed or variable length, their extent being analysable from beginning to end. A typical tagging is the one bit tagging, which should preferably used as follows : value "0" indicates that the IE is no more than the tag bit, and "1" indicates that the IE continues at least with the next bit.

Variable length tagging should be used to distinguish between several possible formats of the element. Tag lengths are then chosen according to packing efficiency criteria.

The T field of standard IEs can be presented as a variable tagging with only two lengths : 4 and 8 bits.

The length indicator can be of fixed or variable length, their extent being analysable from beginning to end. It should preferably be presented as encoding the length in bits of the value part.

The L field of standard IEs can be presented as a fixed length (one octet) length indicator which can encode only lengths multiple of 8 bits.

The value part can be described as further structured, in a similar way. This can be used to help the reading, and to cover some presence dependence.

## 11.4 Handling of superfluous information

All equipment should be able to ignore any extra information present in an L3 message, which is not required for the proper operation of that equipment. For example, a mobile station may ignore the calling party BCD number if that number is of no interest to the Mobile Station when a SETUP message is received.

### 11.4.1 Information elements that are unnecessary in a message

The relevant protocol specification may define certain IEs to be under some conditions unnecessary in a L3 message. A protocol entity detecting an unnecessary IE in a received L3 message shall ignore the contents of that IE for treating the message; it is not obliged to check whether the contents of the IE are syntactically correct.

### 11.4.2 Other syntactic errors

This section applies to the analysis of the value part of an information element. It defines the following terminology:

- An IE is defined to be syntactically incorrect in a message if it contains at least one value defined as "reserved", or if its value part violates syntactic rules given in the specification of the value part. However it is not a syntactical error that a type 4 standard IE specifies in its length indicator a greater length than possible according to the value part specification : extra bits are ignored.
- A message is defined to have semantically incorrect contents if it contains information which, possibly dependant on the state of the receiver, is in contradiction to the resources of the receiver and/or to the procedural part.

# Annex A (informative): MN-Service arrow diagram

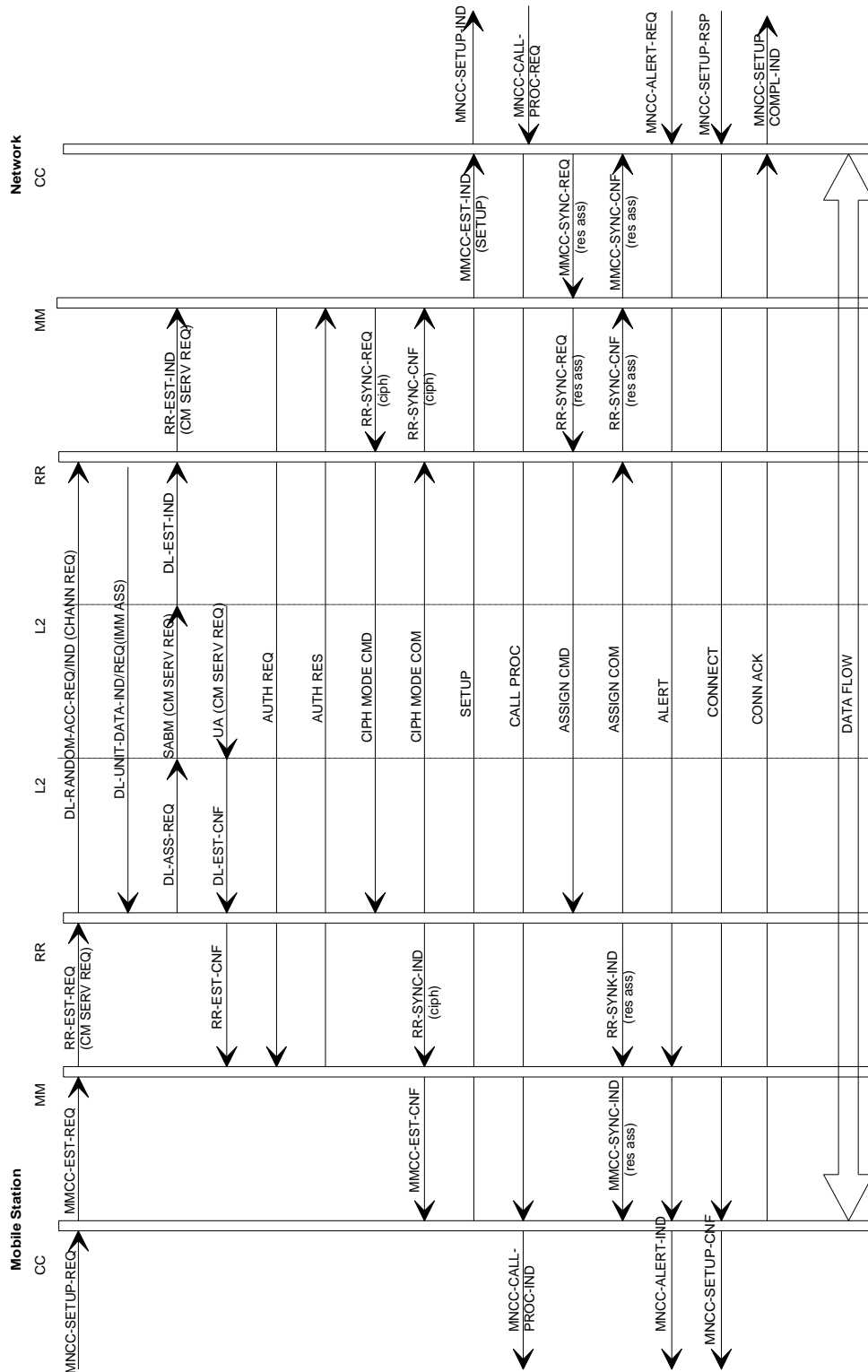


Figure A.1: Mobile originated Call Setup. Successful case



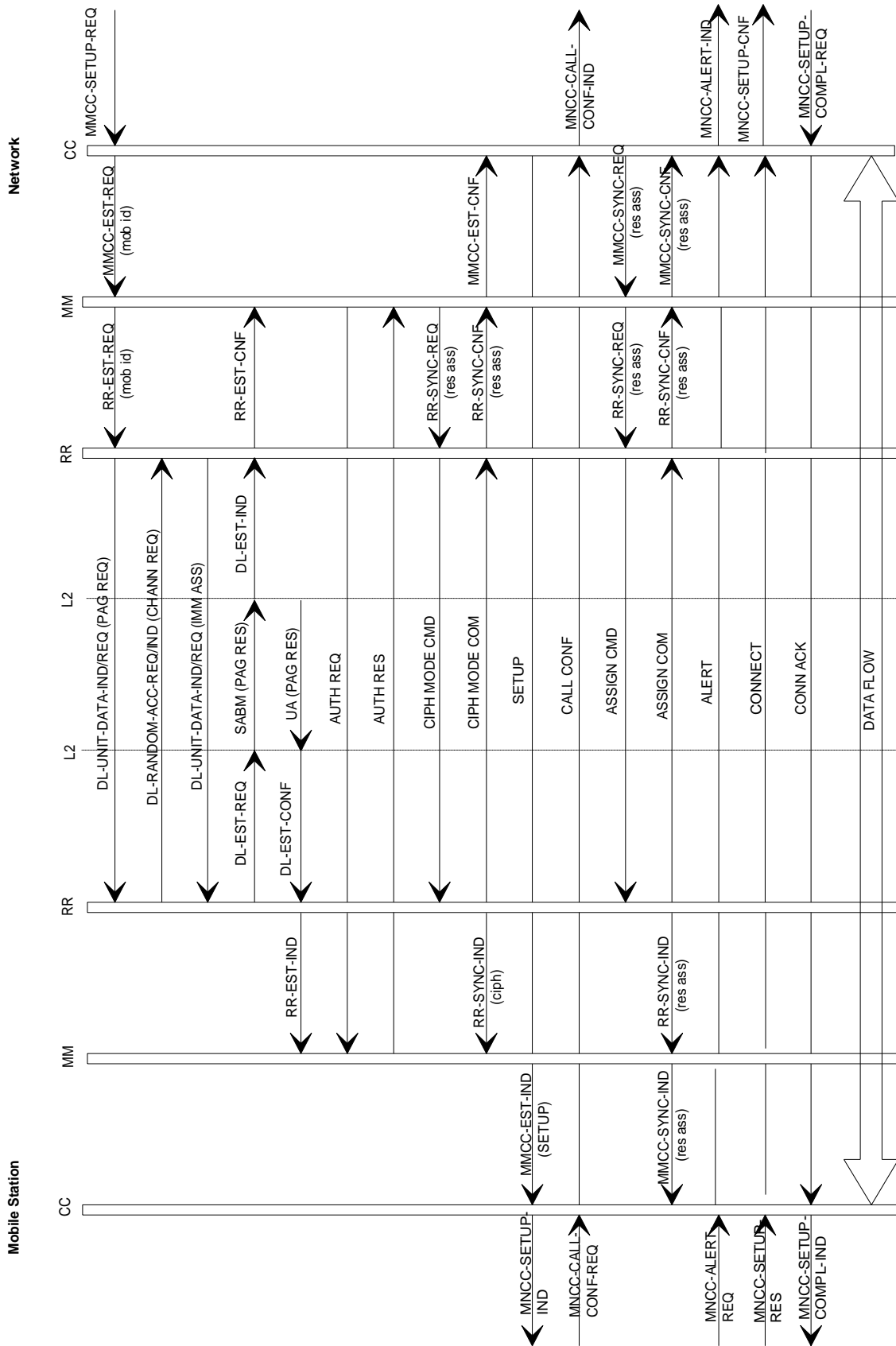


Figure A.2: Mobile terminated Call Setup. Successful case

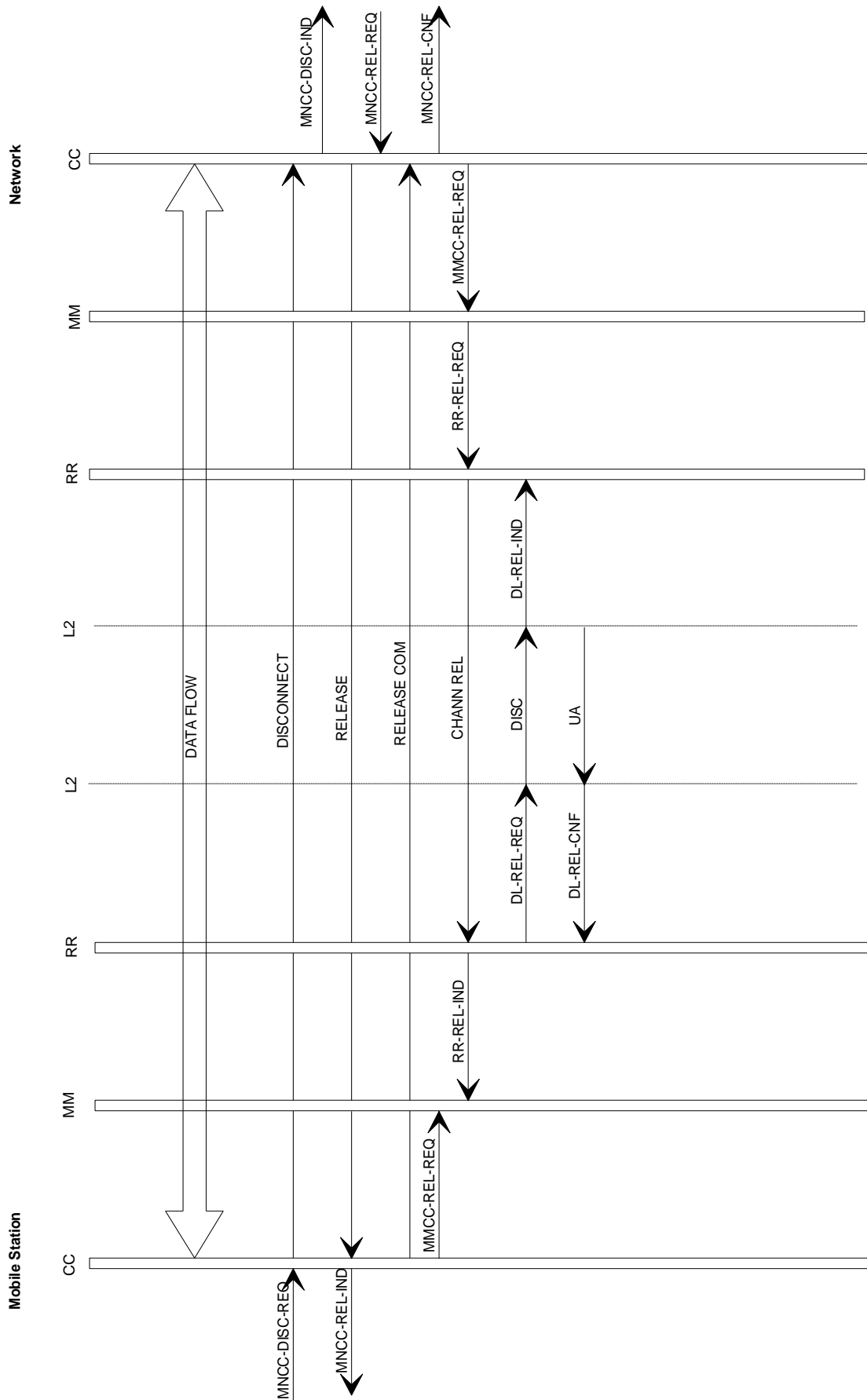


Figure A.3: Mobile originated, Call Release and Channel Release. Successful case

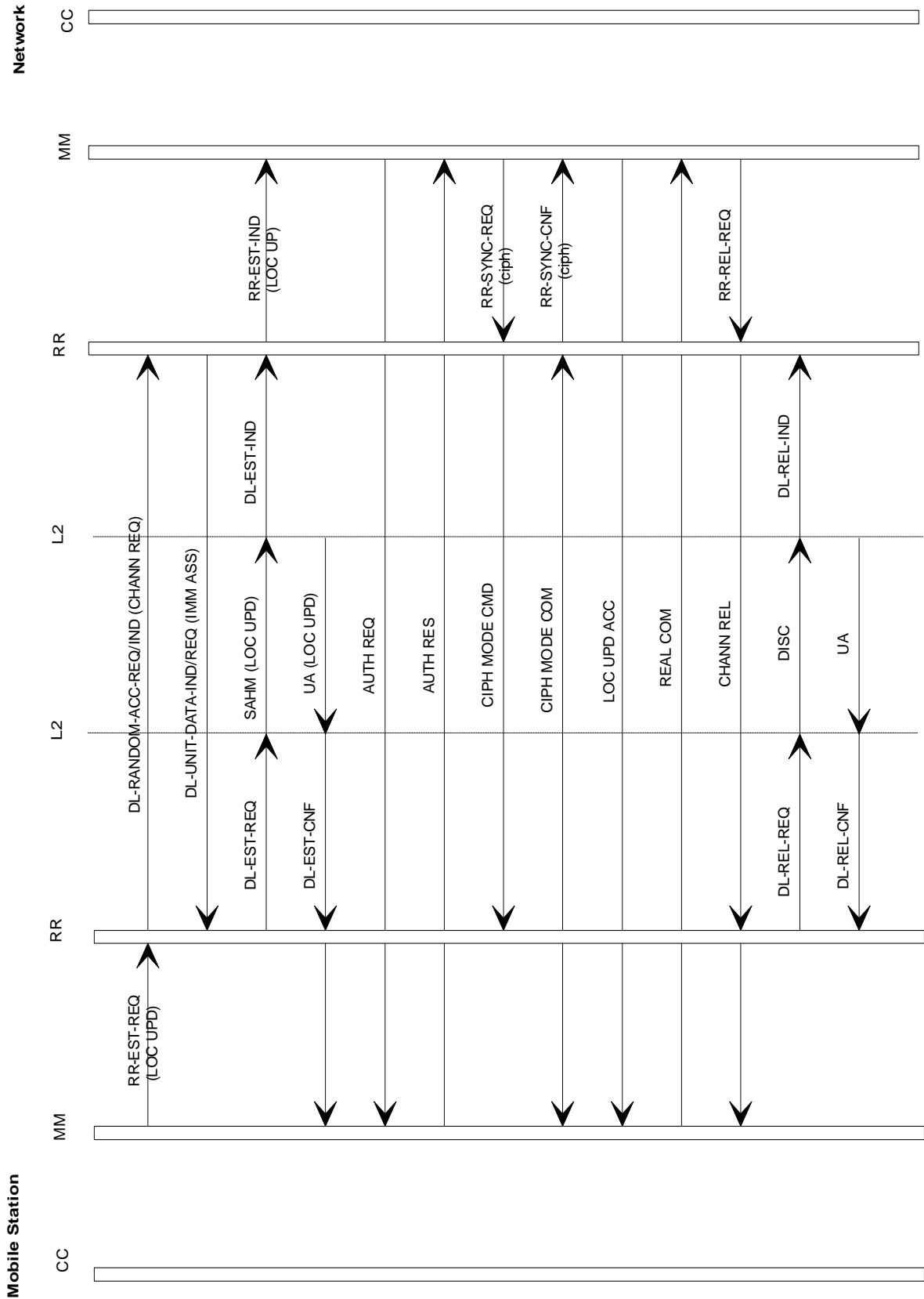


Figure A.4: Location updating. Successful case

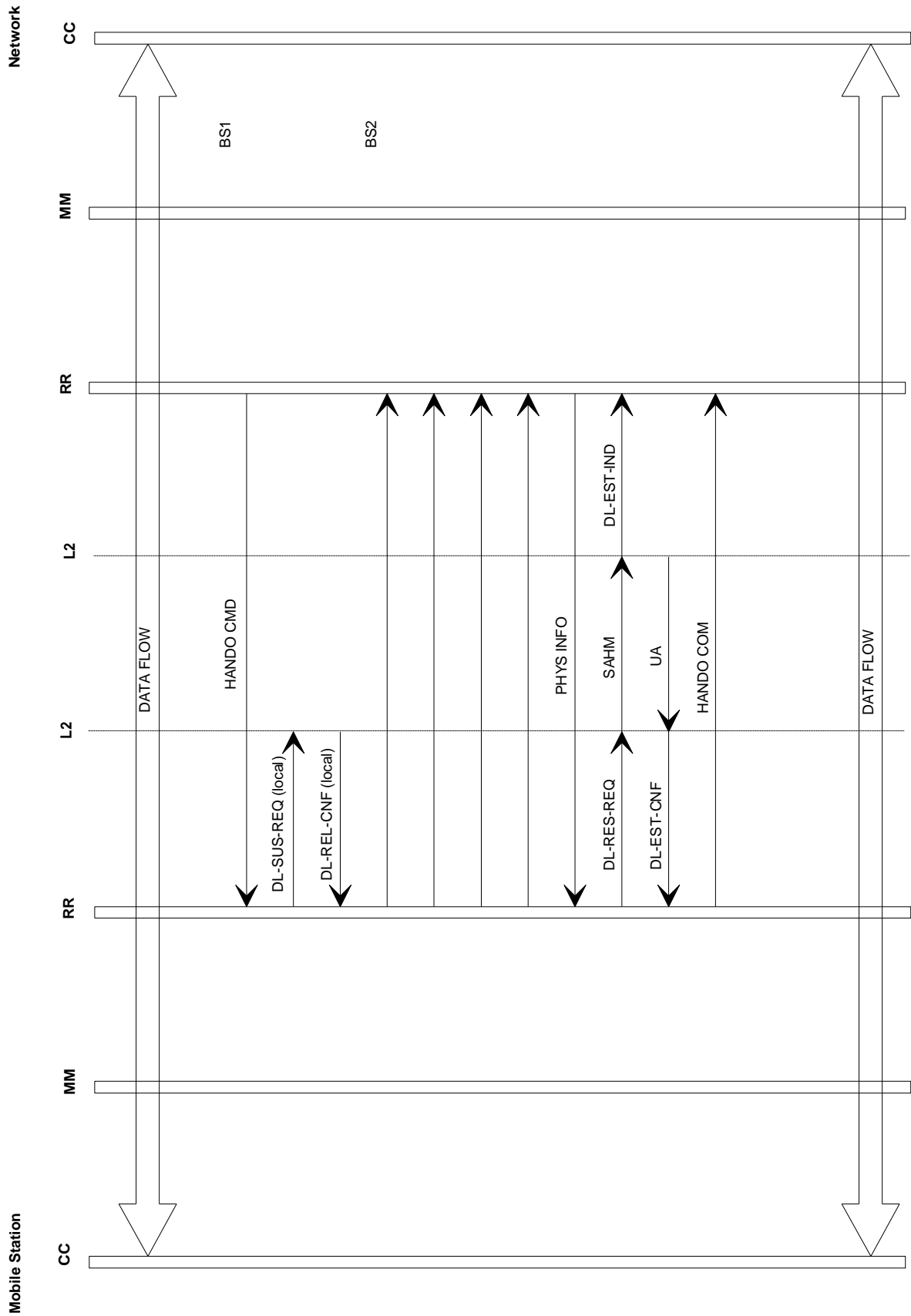


Figure A.5: Handover. Successful case

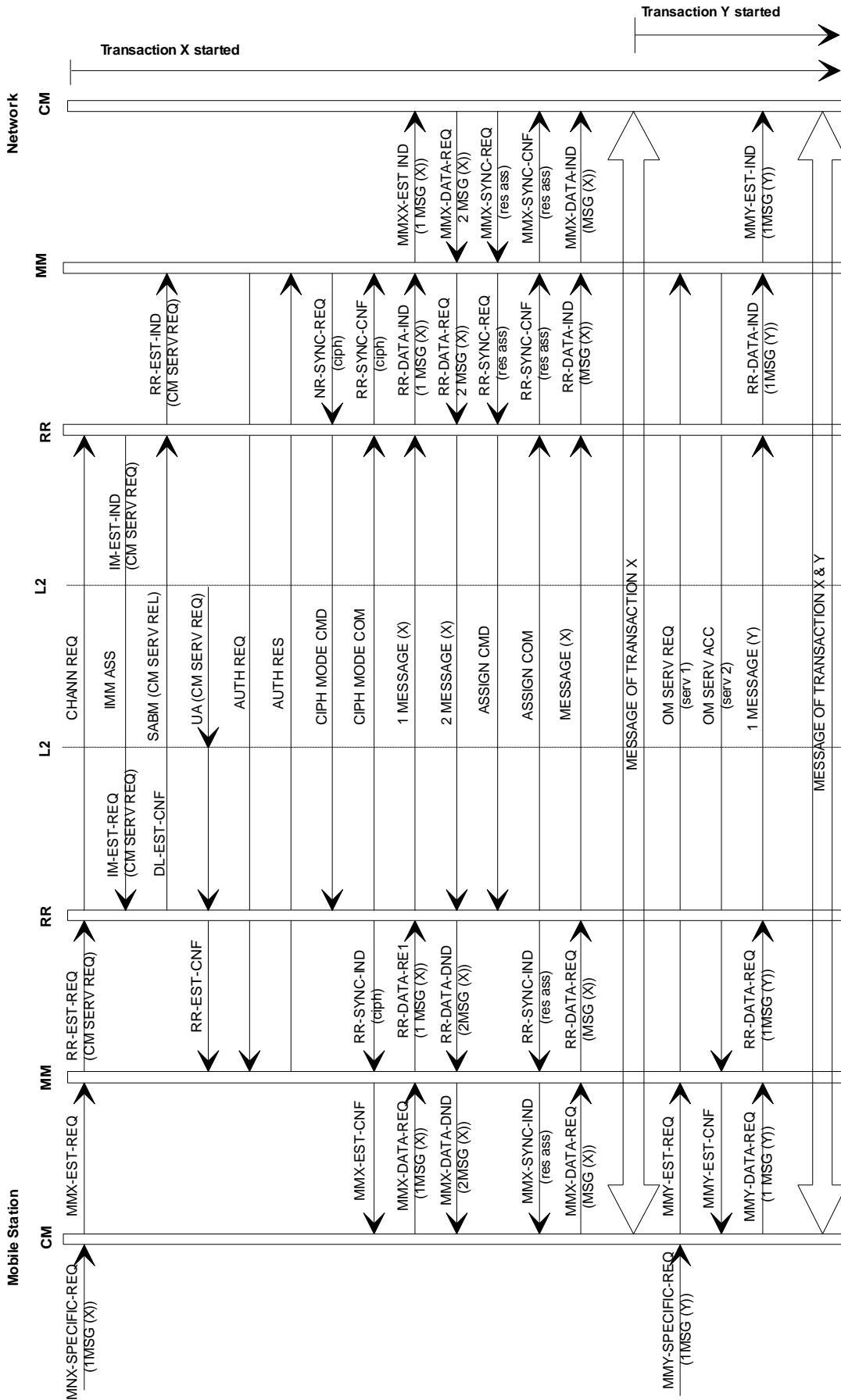


Figure A.6: Establishment of parallel transactions (General view)

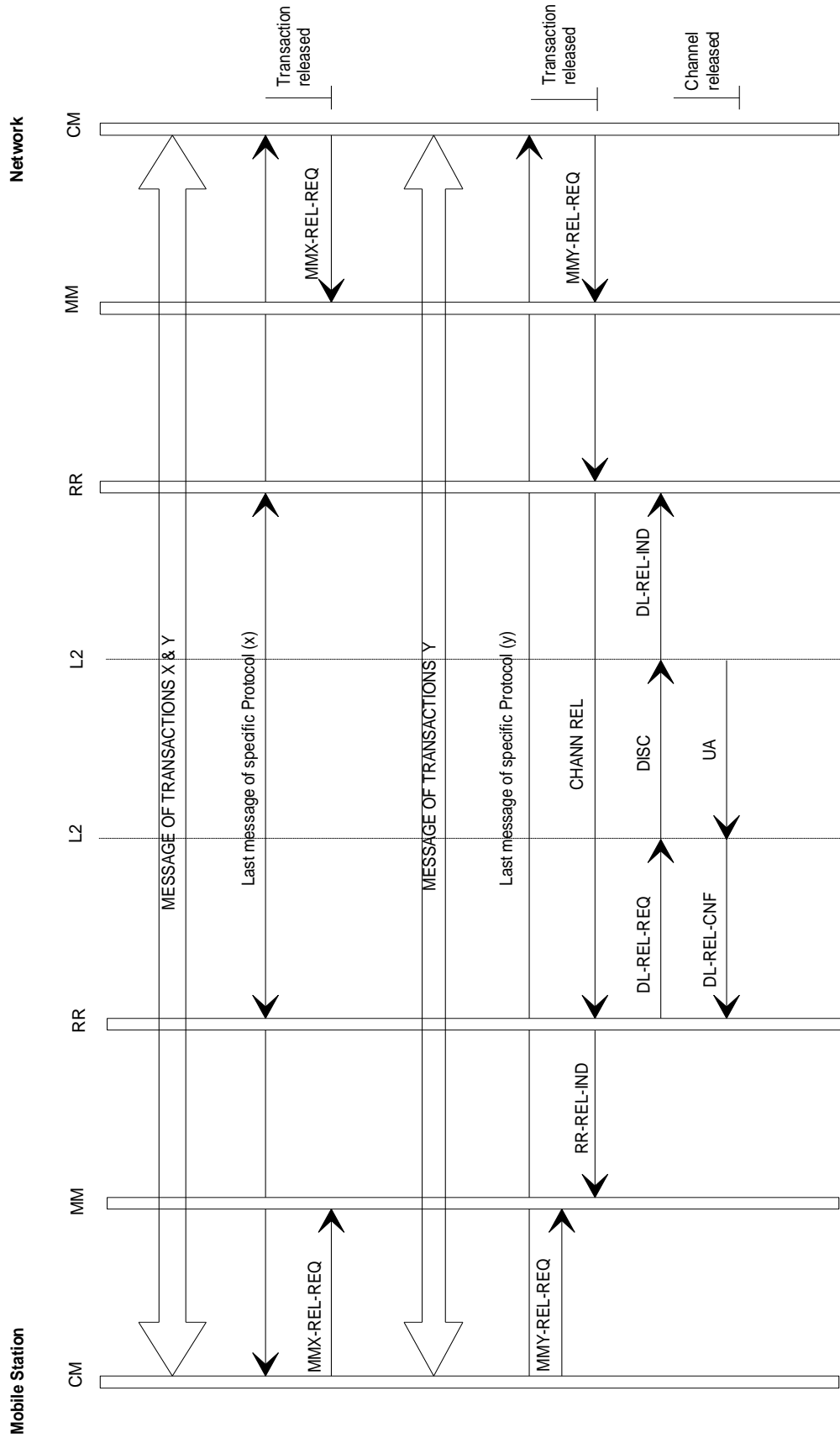


Figure A.7: Release of parallel transactions (General view)

---

## Annex B (informative): Description of CSN.1

The goal of the notation described hereafter is to describe the structure of the syntactically correct messages for a given signalling protocol, or of part of such messages. The notation addresses the cases where the concrete messages are binary strings. The notation allows to describe *sets* of strings : the structure of a message defined a protocol defines a set of allowable bit strings. It also allows to put labels on parts of strings that follow a given structure.

One aspect of the specification of message set is to define the set of strings that are acceptable as when received. All the strings that cannot be recognised as syntactically correct messages are to be rejected for syntactical reasons. In many cases, only a subset of this set are allowed to be sent. The notation allows also to distinguish the set of the strings that can be sent and the set of strings that are recognised as syntactically correct.

Another aspect of the specification of messages is the splitting of an acceptable string in a number of sub-strings that will be use to derive the exact significance of the message. The notation provides this function by labelling sub-strings. These labels can then in turn be used in textual or formal semantic descriptions which are not covered in the present document.

The notation described here could be enhanced in the future, with the addition of new rules.

---

### B.1 The Basic Rules

The following rules (B1 to B6) form the core part of the notation, more or less directly inherited from BNF. Rules B7 to B8 add what is needed in addition to encode the rest octet parts of fixed length messages as defined in GSM 04.08.

Rule A1 is not needed to describe sets of strings at this stage. It is the one allowing to label parts of messages.

#### B.1.1 Core Rules

##### B.1.1.1 Rule B1 : Bits

A "bit string" is an ordered sequence of symbols, each belonging to a two-value set.

The character "0" and "1" are used to indicate one bit, respectively of one or the other value.

Formally, the notations « 0 » and « 1 » denote each a set composed of a single bit string of a single bit, of different values.

In addition the word "bit" denotes the set of the two 1-bit long strings, namely 0 and 1.

##### B.1.1.2 Rule B2 : Null String

Where needed, the word "null" call be used to indicate the null string, i.e., the string of no symbols.

Formally, the notation « null » denote the set composed of a single bit string, the empty string.

### B.1.1.3 Rule B3 : Concatenation

A succession of two string descriptions describe the concatenation of the strings.

More formally : a succession of two string descriptions describes the strings obtained by concatenation of one string taken in the subset described by the first string description and then one string taken in the subset described by the second string description. The rule extends to any number of string descriptions.

For instance

00
----

This denotes the set composed of the single bit string of length 2 composed of two zeros.

### B.1.1.4 Rule B4 : Choice

A list of choices is noted using as separator the character "|". An alternative notation uses instead the word "or" (this is not used in the present document).

**NOTE:** An idea is to allow not to used strange characters, by giving in each case a verbose equivalent. This is not done systematically yet in the present document.

Formally : the notation  $A | B$ , where  $A$  and  $B$  are string set descriptions, describes the set of the strings which are in the set described by  $A$  or in the set described by  $B$ , that is the union of sets described by  $A$  and  $B$ .

The concatenation has a higher precedence than the choice.

Examples:

00 01
-------

This indicates that bit strings 00 and 01 are part of the set (10 and 11 are not).

0 1
-----

denotes the same set as "bit".

The characters "{" and "}" are used for delimiting a string set description from what follows and/or precedes.

0 {0 1}
---------

This indicates the same set of bit strings as in the previous case.

Precedence example :

10 11 1 0 1
----------------

Because of the priority rule, the two descriptions are not equivalent, the second noting the set (10, 1).

It is allowed that the different sets in a choice have non null intersections. To allow message decoding, a rule must then be given to choose the branch. The rule is that any matching set can be chosen (the concatenation is a true set union).

In practice, it is preferable to have non intersecting choice sets. Moreover, the ability to select the branch to take rapidly is important for obtaining simple message decoders. Except for strong reasons, a design should only include choice construction that can be rewritten using only constructions matching the pattern  $\{a_1 s_1 | a_2 s_2\}$  where  $a_1$  and  $a_2$  are non-intersecting sets of strings of the same non-null length. A tolerable derogation is to use intersecting  $an$ .

Examples:

{100 xx|001 zz} is acceptable.

{00 xx|010 yy|011 zz} is acceptable, since it can be rewritten {00 xx|01 {0 yy|1 zz}}.

{{00|01}10} xx| {00|11} yy} is not recommended (the start 00 is ambiguous).



In practice this covers fixed length tagging (like tagging by an IEL, or 1-bit tagging in rest octets), and also non-intersecting variable length tagging as used for instance in the frequency list IE (tag list such as 0, 100, 101, 110, 11100, 11101, 11110, 11111, where no tag is the start of another one).

### B.1.1.5 Rule B5 : Naming

The characters "<" and ">" are used to delimit a *reference* to the description of a string set. This can be used inside a string set description, to refer to a string set described elsewhere.

For compilability, the name must be used somewhere else to define the corresponding string set. For a simple description, the description of the reference could be done by normal text.

The name, that is the part sequence of characters between "<" and ">" must not be empty, and is constituted freely of characters, with the exception of "<" and ">". Case is not significant, nor are heading or tailing spaces. Any succession of space characters is treated as a single character. To avoid difficulties with more advanced rules, the use of the characters ":", "=", "(", and ")" should be avoided. More generally, it is not recommended to use many other characters, such as "<" for instance. The space character can (and should!) be used, to allow a good legibility for human beings.

Example :

```
<bit pair>
```

### B.1.1.6 Rule B6 : Definition

A reference followed by the character sequence "::<=" followed by a string set description is used to associate the description with the reference, terminated when needed to separate it from a following definition and when compilability is looked for, by a semi-colon ' ; '.

Recursive definition is allowed, e.g., the reference can appear on the right hand side of the "::<=" . To avoid too much difficulties for would-be-compilers, only tail recursivity should be used, i.e., a recursive term should appear only as the last term of a definition.

Examples:

```
<bit pair> ::= 00 | 01 | 10 | 11 ;
```

This could have been noted as well :

```
<bit pair> ::= {00 | 01 | 10 | 11} ;
```

or

```
<bit pair> ::= {0|1} {0|1} ;
```

Recursive example :

```
<all bit strings> ::= null | { 0 | 1 } <all bit strings> ;
```

Another recursive, but not tail-recursive (and then not recommended) example :

```
<all bit strings> ::= null | { <all bit strings> 0 | 1 } ;
```

## B.1.2 Spare parts

For the purpose of message description it is in many cases needed to specify differently the set of bit strings that are acceptable when received and the corresponding set of bit strings which may be sent. The second set is included in the first. A first example are the spare parts.

Notations related to spare parts are different in nature from the bit string set description seen so far. They define two sets at the same time, the sent set and the received set. A construction rule of general application will be defined in advanced rules. For the moment, only two ad-hoc constructions are described.

### B.1.2.1 Rule B7 : Spare bits

The following construction

```
<spare bit>
```

describes a 0 when emitted and a bit (0 or 1) in reception.

### B.1.2.2 Rule B8 : Padding bits

An issue specific to the GSM radio interface protocols is that in some cases the messages cannot take arbitrary lengths. Padding is then necessary to fill up the message up to the desired length. Moreover, the padding uses a particular sequence of bits, of fixed position, i.e., the value of a padding bit depends on its position relative to the start of the message. The padding sequence is protocol-specific. In most cases it is constituted of all 0 values, in which case the following notation is of no use. In the case of GSM 04.08, the padding sequence is the repetition of octet 00101011, starting on an octet boundary.

The special notations "L" and "H" are used to denote the respectively the bit value corresponding to the padding spare bit for that position, and the other value.

The notations "0", "1", "null", "L" and "H" are the only terminals in CSN.1.

Padding spare bits are bits which are set to the indicated value in emission whereas in reception any bit string is acceptable. The following notation

```
<spare L>
```

describes a bit which has a logical value L in emission, and is a bit (0 or 1) in reception

The term <spare padding> denotes the required padding spare bits needed to fill up the message. The construction can be developed only partially from the rules described so far, because the length limitation does not appear in the following description :

```
< spare padding> ::= <spare L> {null | < spare padding>};
```

### B.1.3 Predefined sets

The notation allows a modular description of the messages. This means in particular the possibility to build a library of bit string set definitions to be used wherever needed. The following is an example of an elementary library, which could be specified once and can be used in other specifications without being redefined.

```

<bit> ::= 0|1 ;
<bit (1)> ::= <bit>;
<bit (2)> ::= <bit> <bit>;
<bit (3)> ::= <bit (2)> <bit>;
<bit (4)> ::= <bit (3)> <bit>;
<bit (5)> ::= <bit (4)> <bit>;
<bit (6)> ::= <bit (5)> <bit>;
<bit (7)> ::= <bit (6)> <bit>;
<octet> ::= <bit (7)> <bit>;
<half octet> ::= <bit (4)>;
<spare half octet> ::= <spare bit><spare bit><spare bit><spare bit>;
  <spare padding> ::= <spare L> {null | <spare padding>};

<octet string(i)> ::= <octet>(i);           -- for any positive or null integer i
<bit(i)> ::= <bit>(i);                       -- for any positive or null integer I
<bit string> ::= bit** ;
<octet string> ::= <octet>** ;
```

NOTE 1: The definition of generic constructions such as <bit string(i)> is somewhat cumbersome with only the basic rules. More advanced rules would allow a much more compact notation.

NOTE 2: The use of the characters "(" and ")" within a reference is done consistently with potential advanced rules.

NOTE 3: This basic library is not exhaustive and can be extended when the needs arise.

## B.1.4 Labelling Parts

### B.1.4.1 Rule A1 : Labels

Delimited names as defined by Rule B6 identify sets of sub strings. In many cases this can be used within the context of a message to refer to the specific part of the message. However, this is not of general application, since it may happen that two parts of a message follow the same structure, and economy of notation requires that the structure is described but once.

The general syntax that follows allows to refer to a part inside a description:

*<name1 : string description>*

For the definition of string sets, this is equivalent to the string description being used alone.

The name used as a label can be built according to the rules applicable to parenthesed references.

Examples:

*<Tag : 000 >*  
*<Field : <Field type>>*  
*<Field : octet>*

The third example shows the use of a non parentheses reference to obtain a more elegant expression than, for instance, the second example. At this stage, labels has no use for describing message syntax, but can be used to refer to the corresponding part of the string, e.g., in the description of the message specifying the relationship between the syntactical content and the semantical contents of the message, or to associate properties with effective sub-strings in effective messages (rather than with sets of sub strings). Syntactical use of the semantical identifier are presented in more advanced rules.

The same name may appear in several places. Designers have to be careful to use non ambiguous names if non-ambiguous reference is desired.

## B.1.5 Goodies

### B.1.5.1 Rule G1 : Comments

Comments can be added, starting with the term "--" and ended by the end of line. Comments can be used in particular to indicate the section where a particular description can be found.

---

## B.2 Advanced rules

### B.2.1 Rule A2 : Exponent notation

An arithmetic expression used as exponent after a delimited string description is used to indicate repetitions.

A numerical expression between parentheses indicates a fixed number of repetitions.

```
<octet> ::= {0|1}(8);
```

is equivalent to

```
<octet> ::= {0|1} {0|1} {0|1} {0|1} {0|1} {0|1} {0|1} {0|1};
```

This could also be written :

```
<octet> ::= bit(8);
```

When the exponent is negative or equal to 0, the exponentiated construction is equivalent to the null string.

An example of a common construction is the following :

```
<name : bit(5)>
```

Simple arithmetic, using numbers, terms "+", "-", "\*", and "/", and parentheses are allowed in expressions..

Example :

```
<octet string(40)> ::= <octet>(8*(4+1));
```

A star used alone between parentheses, or a double star, indicates a finite, possibly null, but indeterminate, number of repetitions. (The star used as an exponent can be understood also as meaning the union of all the sets obtained by replacing the star by zero or some positive integer.)

```
<all bit strings> ::= {0|1}(*);  
<all bit strings> ::= {0|1}**;
```

This allows a shorter notation of recursive constructions such as:

```
<all bit strings> ::= {0|1} <all bit strings> | null;
```

A shorter notation is allowed when the expression has a single term, consisting of a star followed by the term:

```
<octet> ::= {0|1}*8;  
<octet string(40)> ::= <octet>*(8*(4+1));  
<all bit strings> ::= bit**;
```

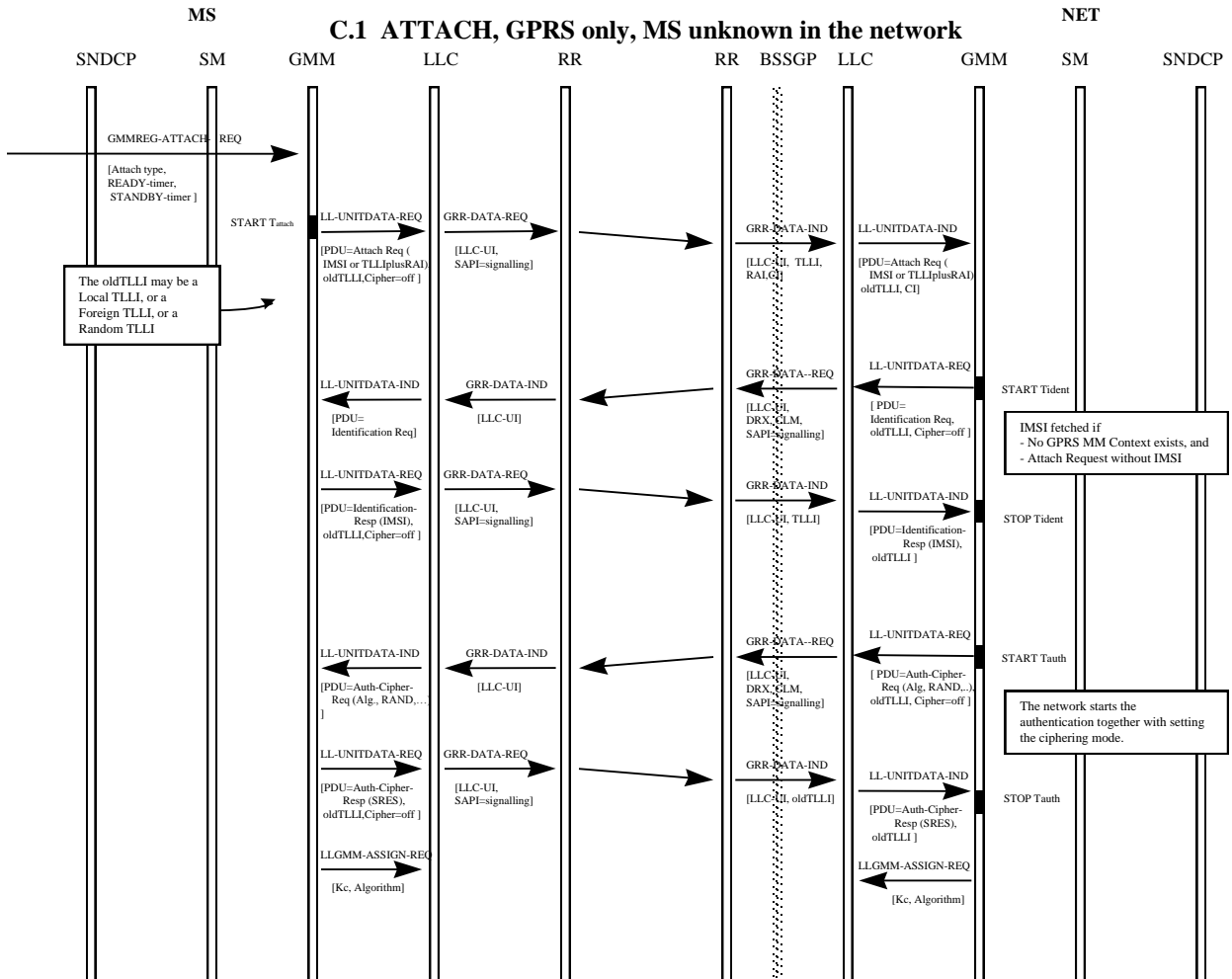
Application note :

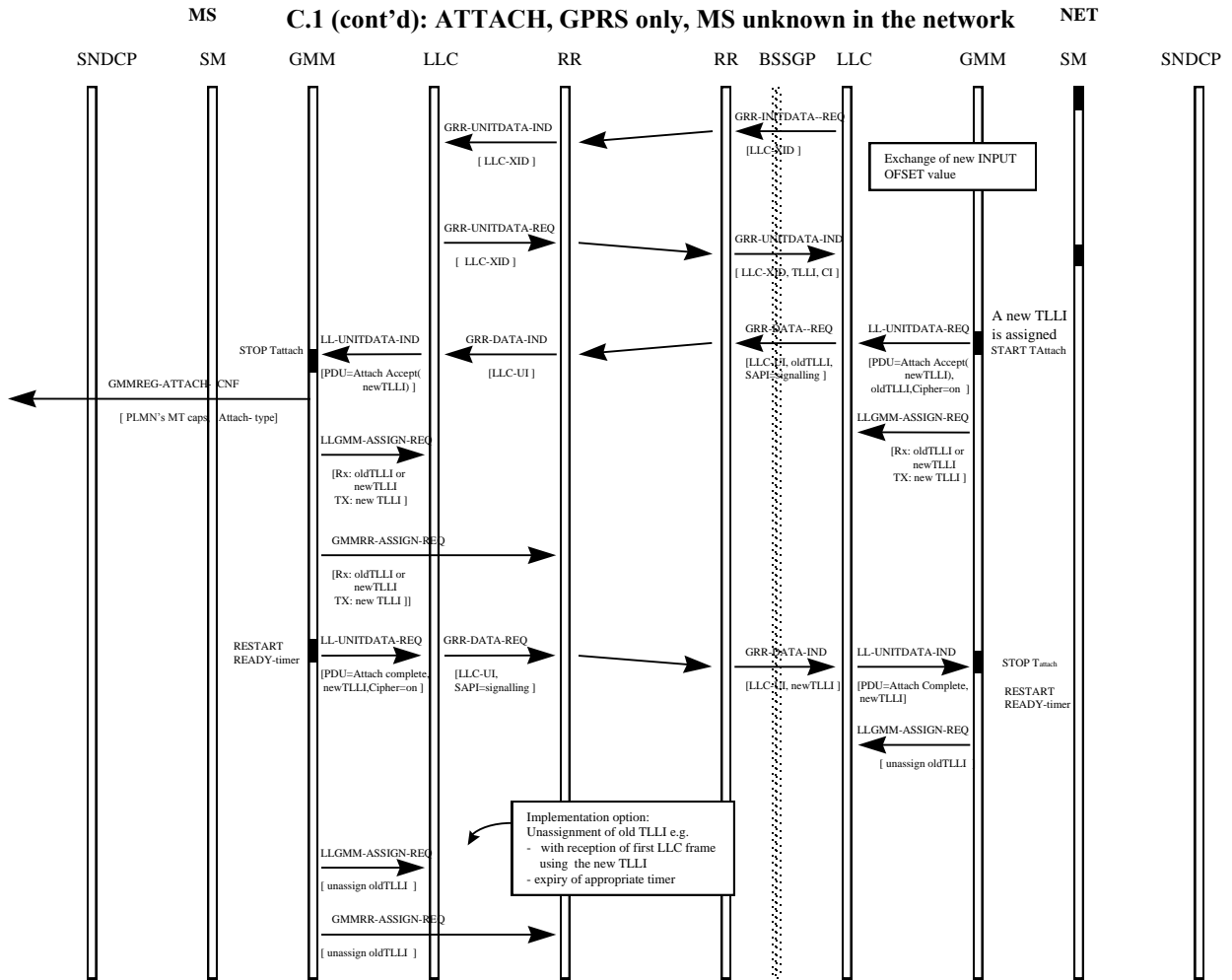
The indefinite exponent is usually combined with some mean to indicate to the decoder the end of the repetition.

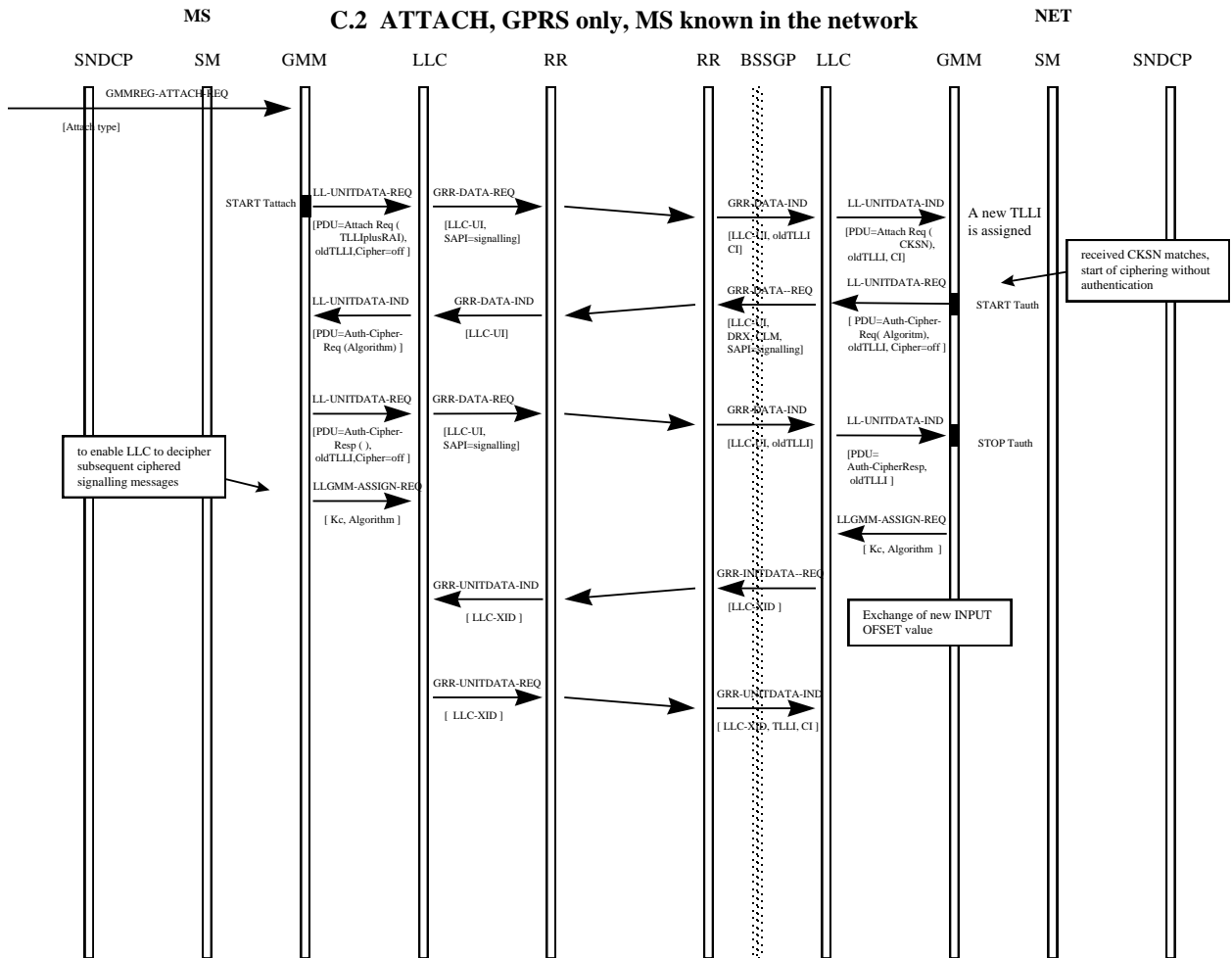
Different techniques exist, such as indicating in a previous field the number of repetitions. Another technique is one-bit tagging, an example of which follows : {1 <item><sup>\*\*</sup> 0

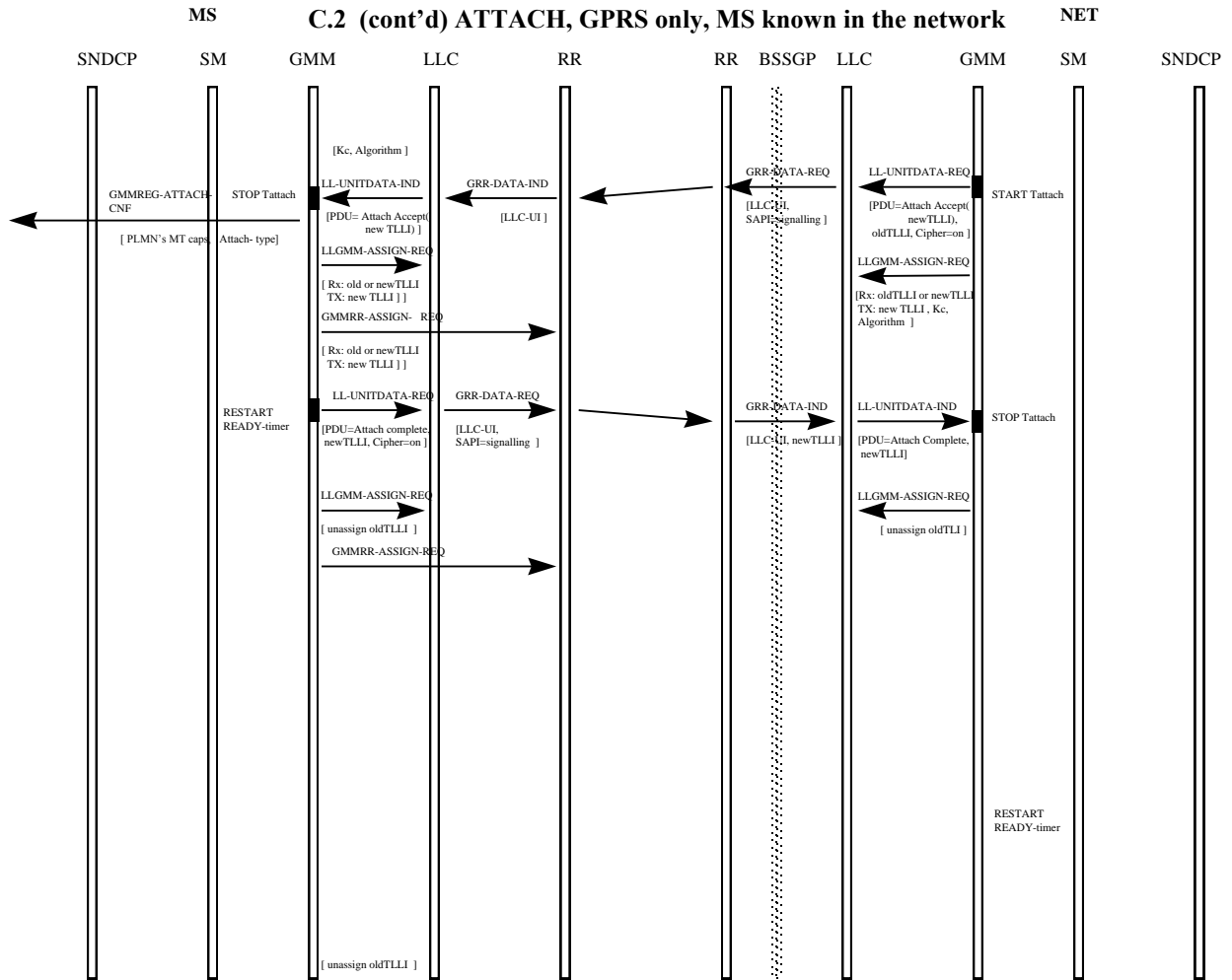
# Annex C (informative): GPRS-Services sequence diagram

Instead of providing a complete set of all scenarios, the intention of this section is to provide some typical examples. It shall be noted, that within the figures only those parameters of the PDUs and the service primitives are shown, which are needed for a general understanding of the examples. Furthermore during the examples below (except C.17) no cell re-selection takes place.

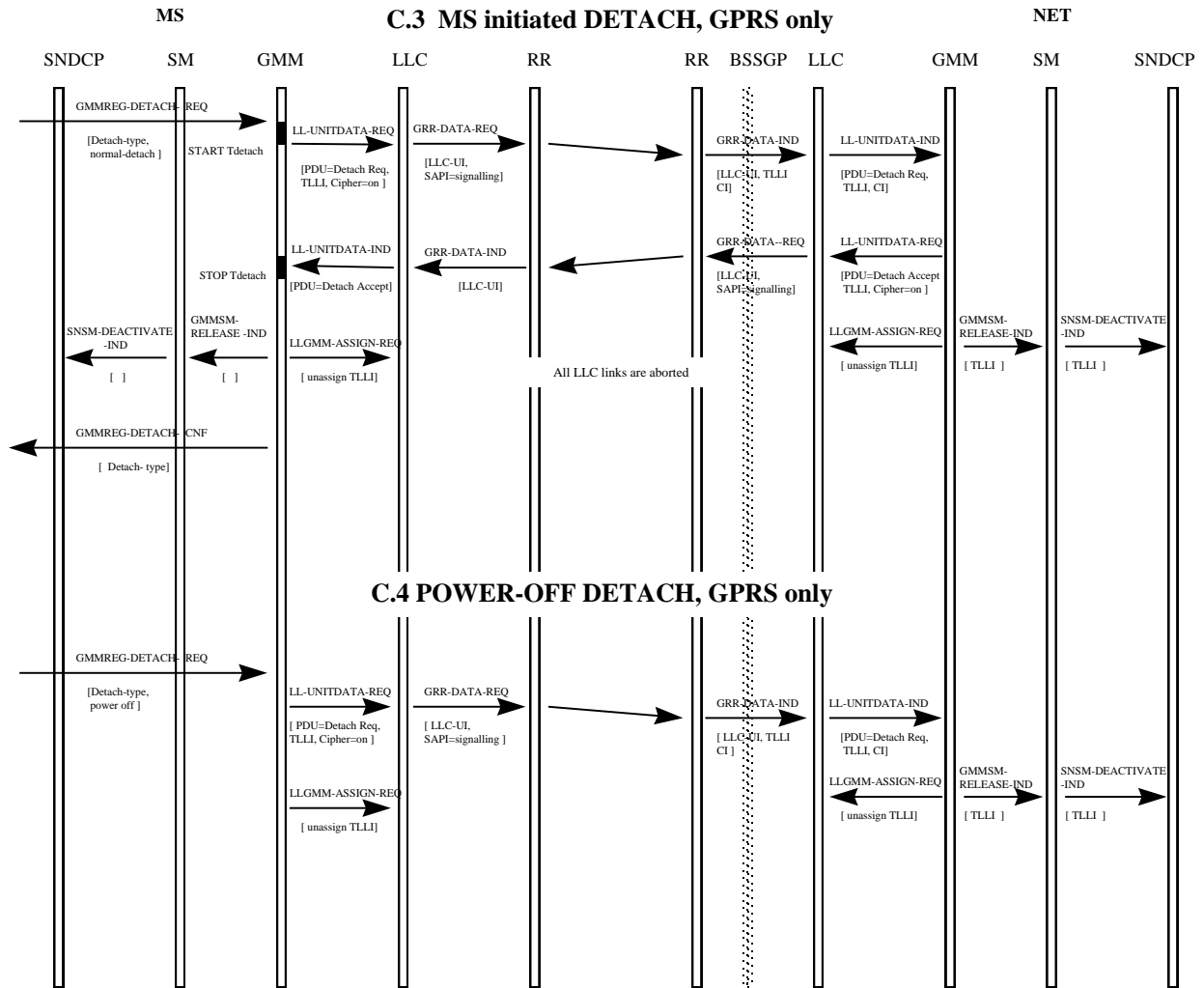


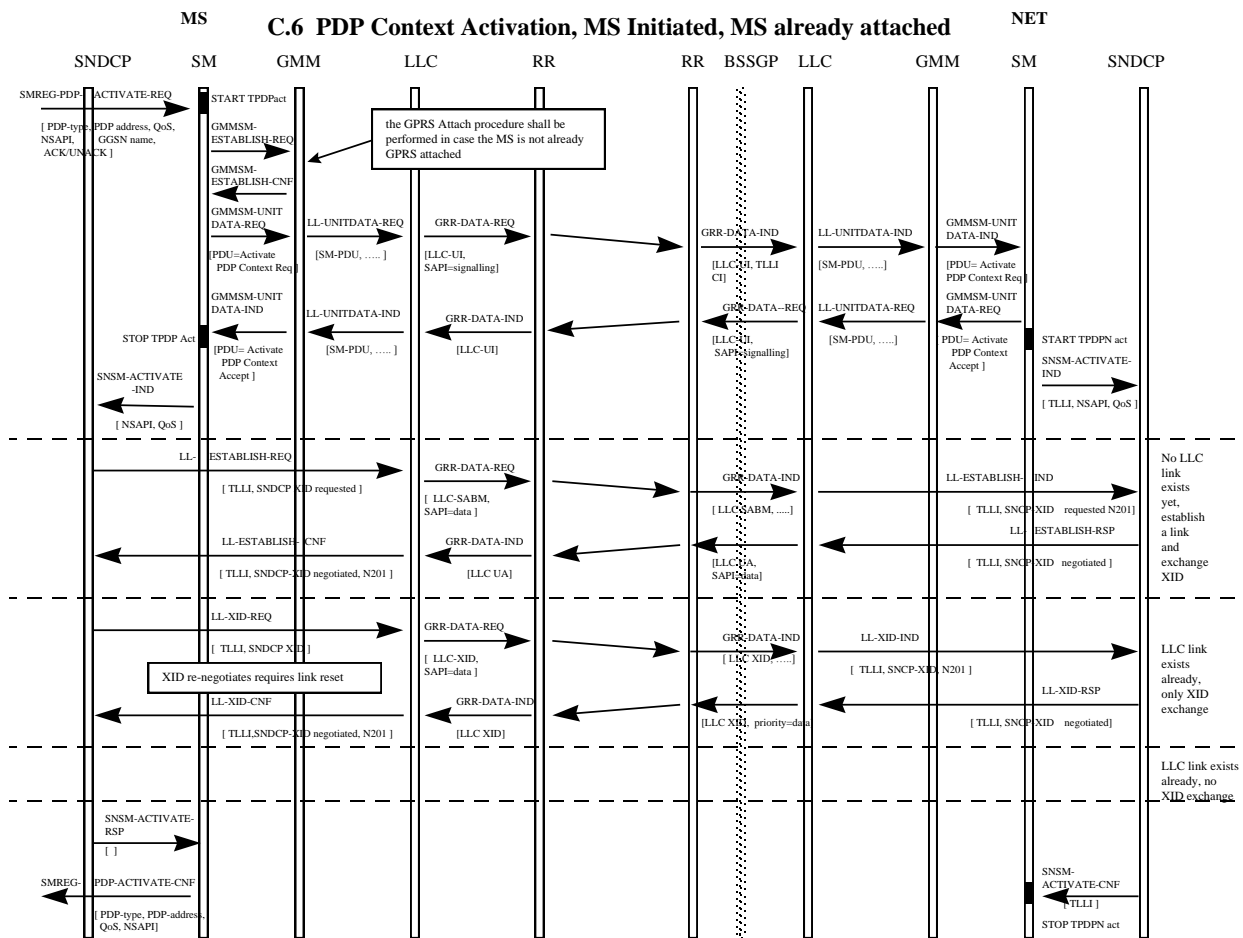
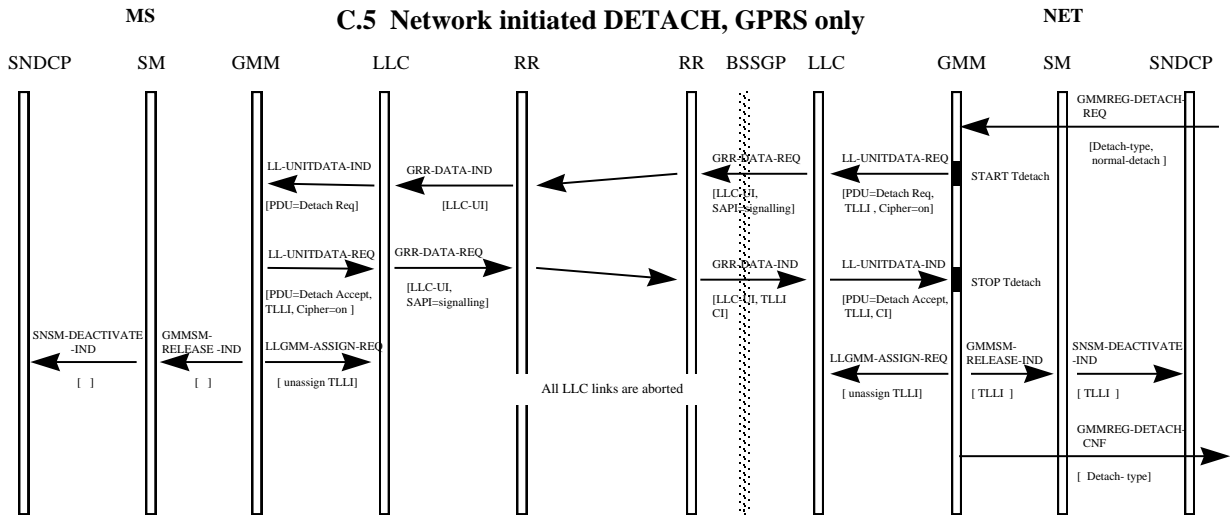


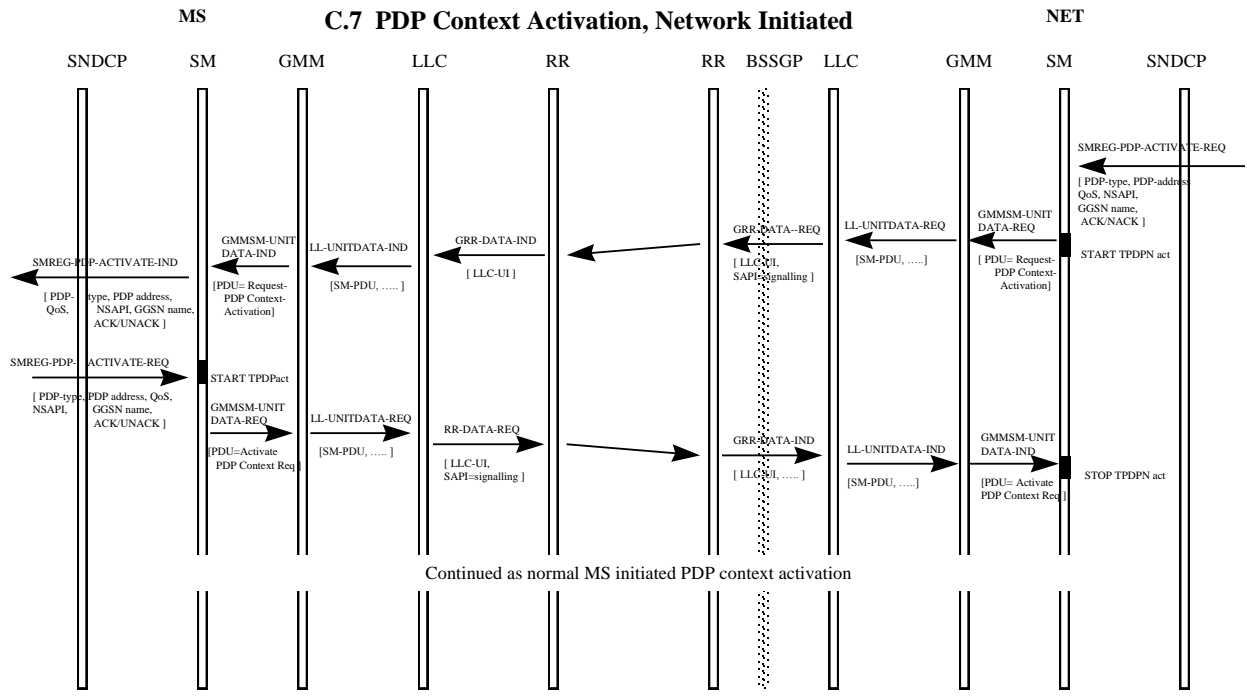


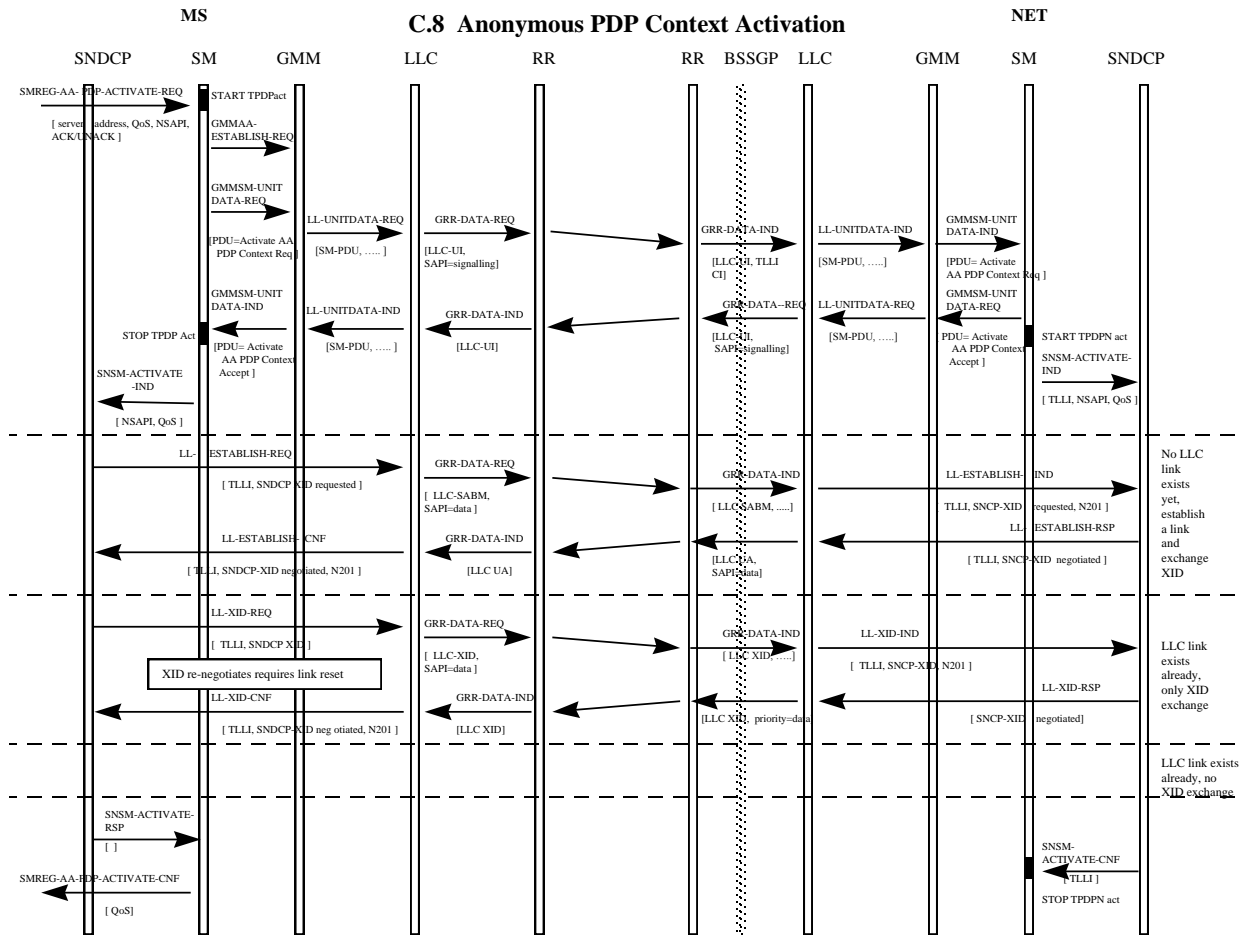


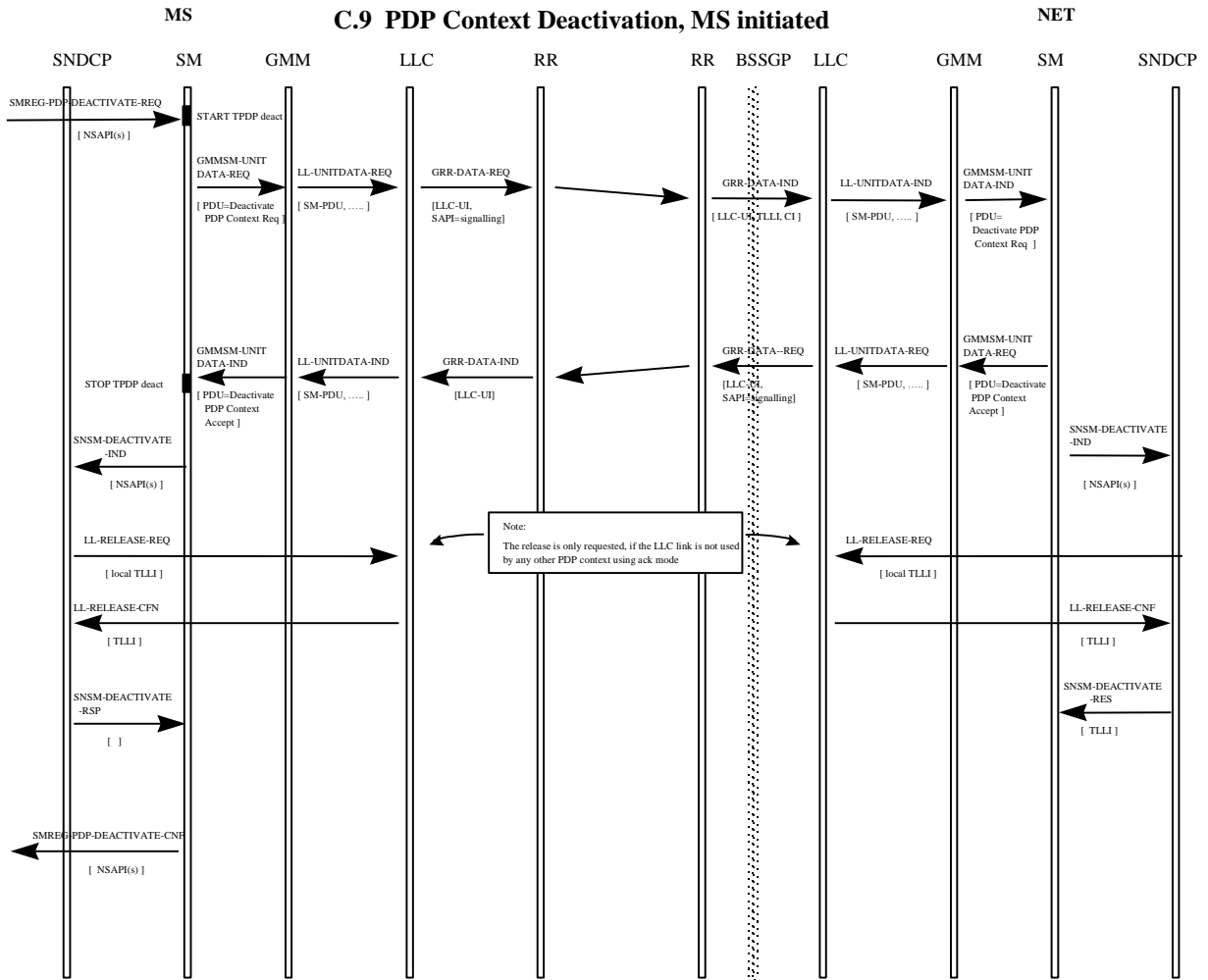


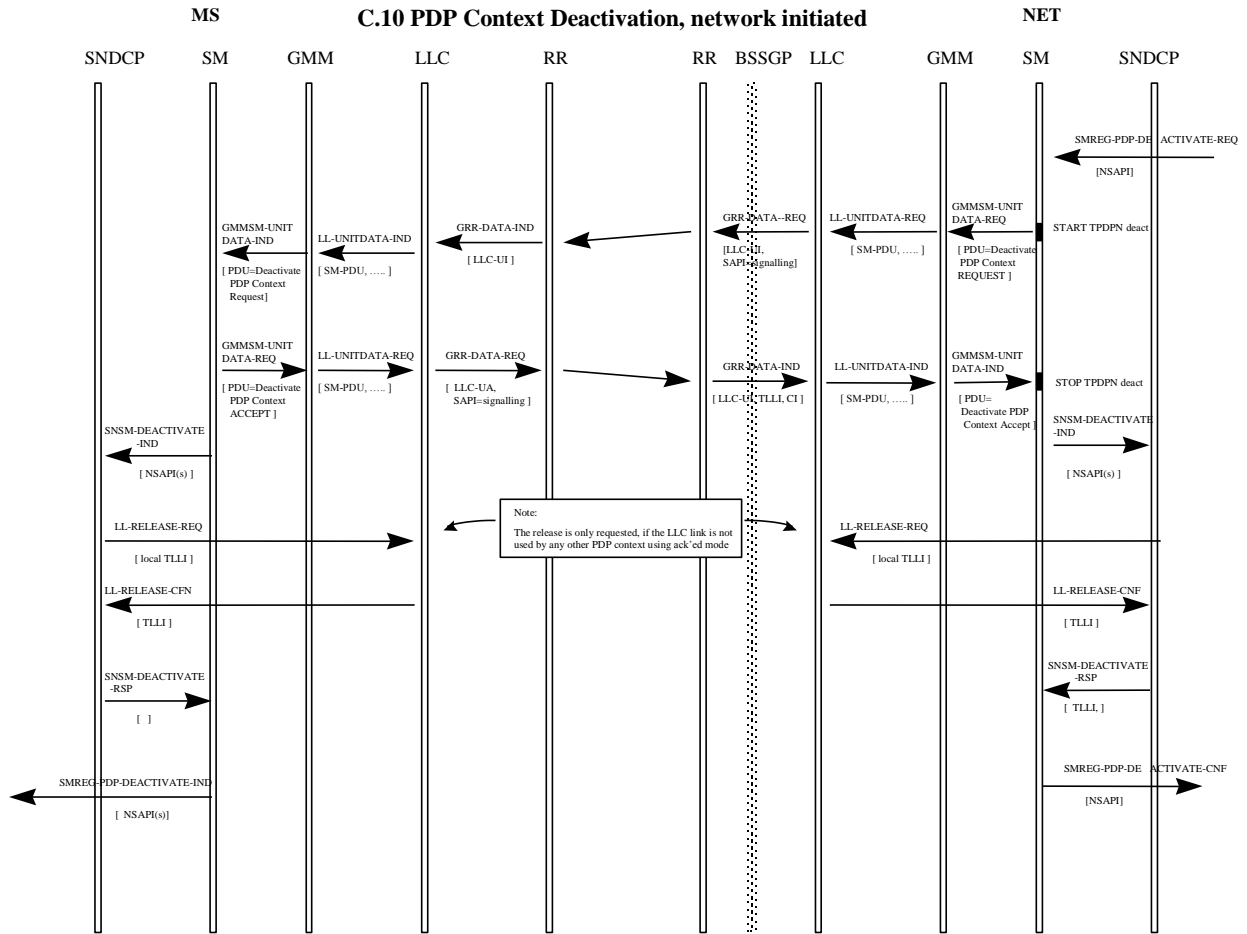


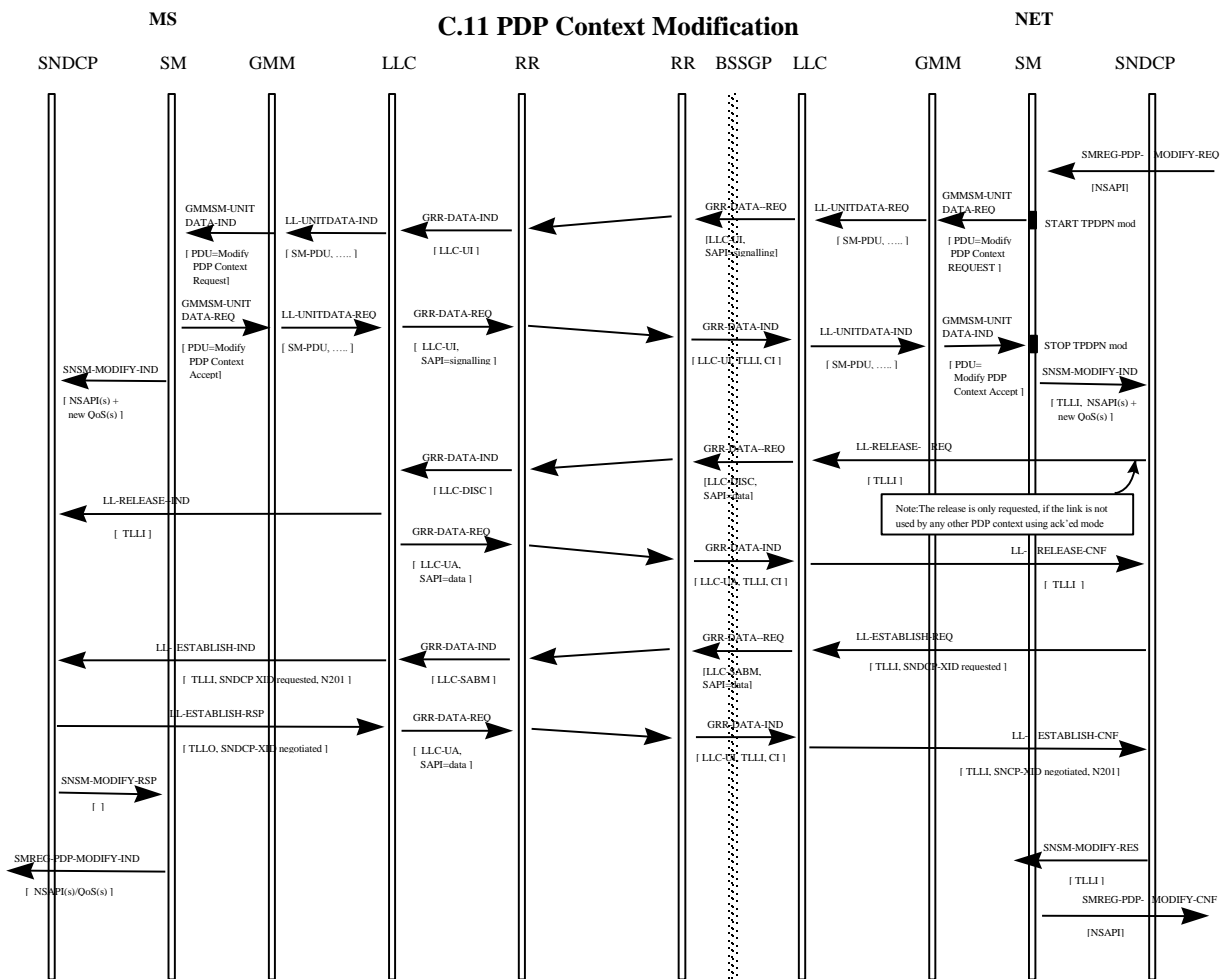




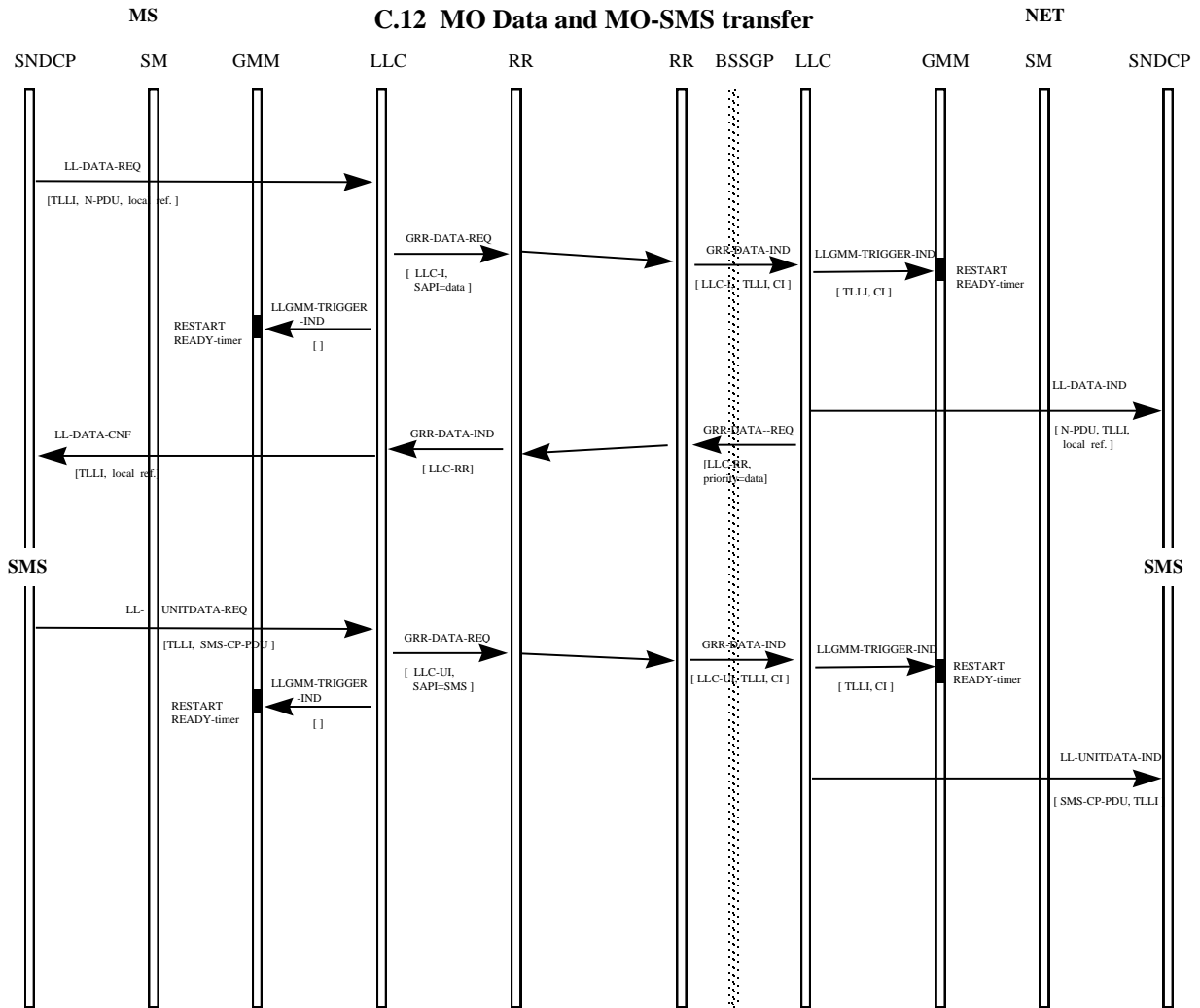




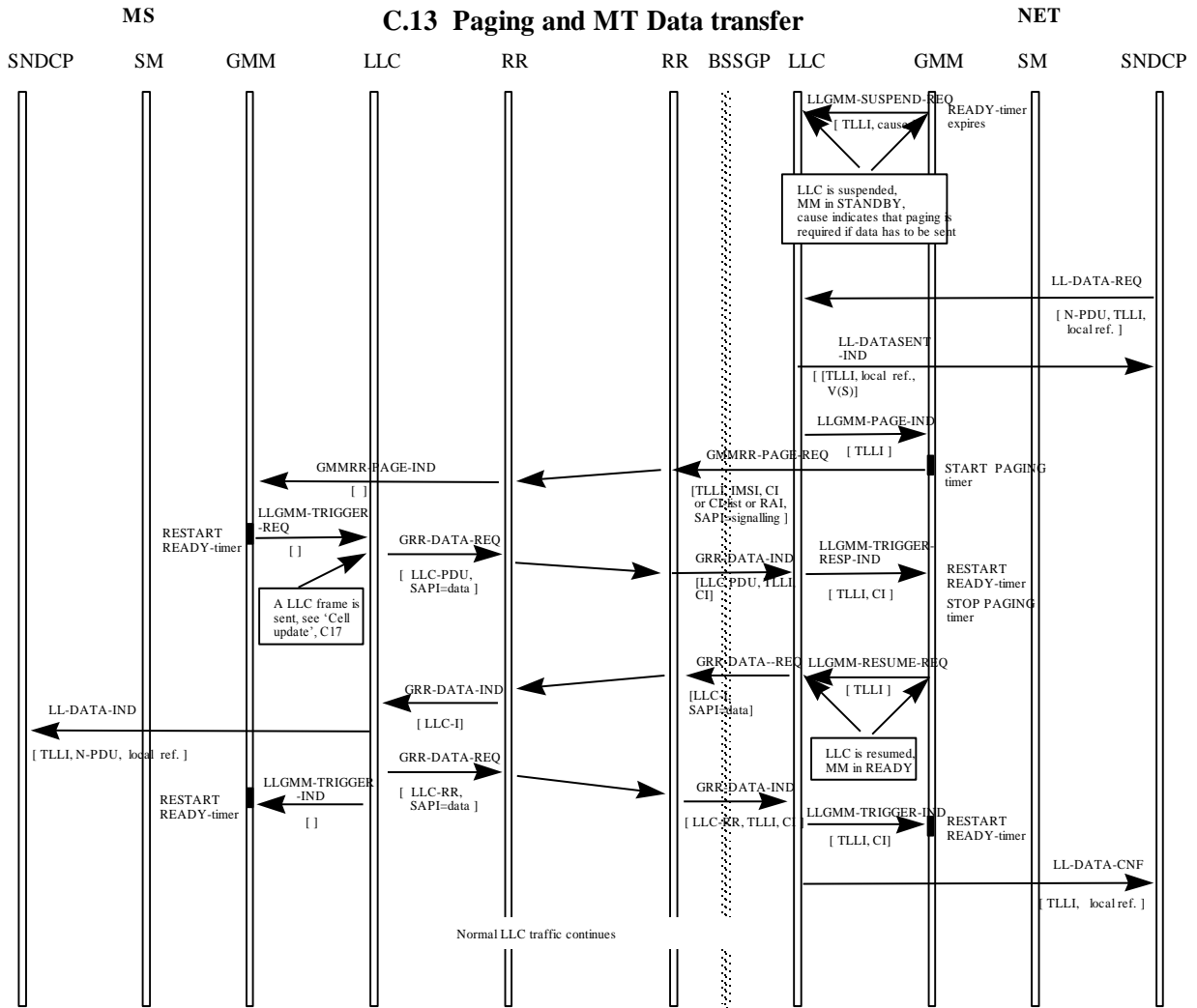


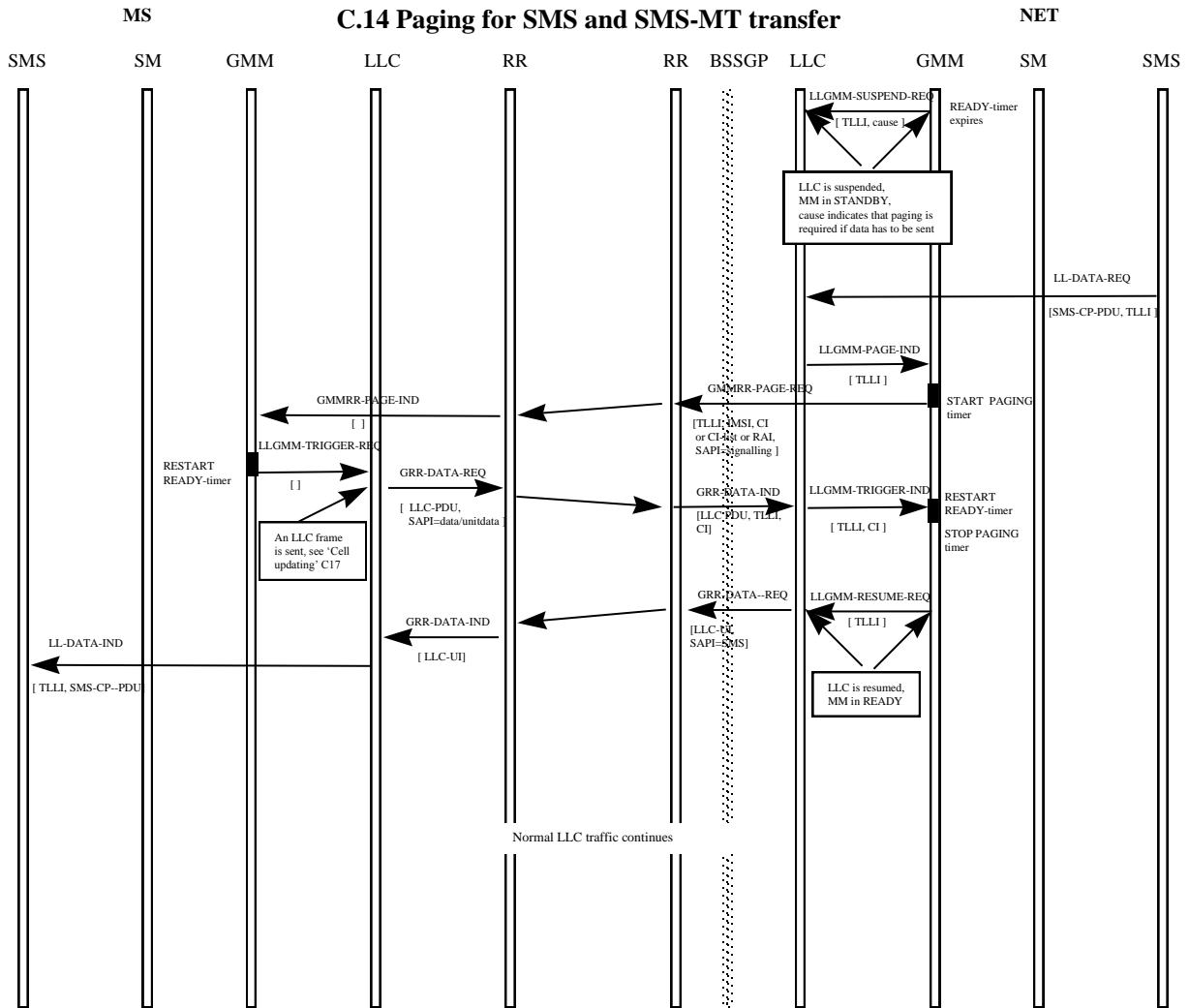


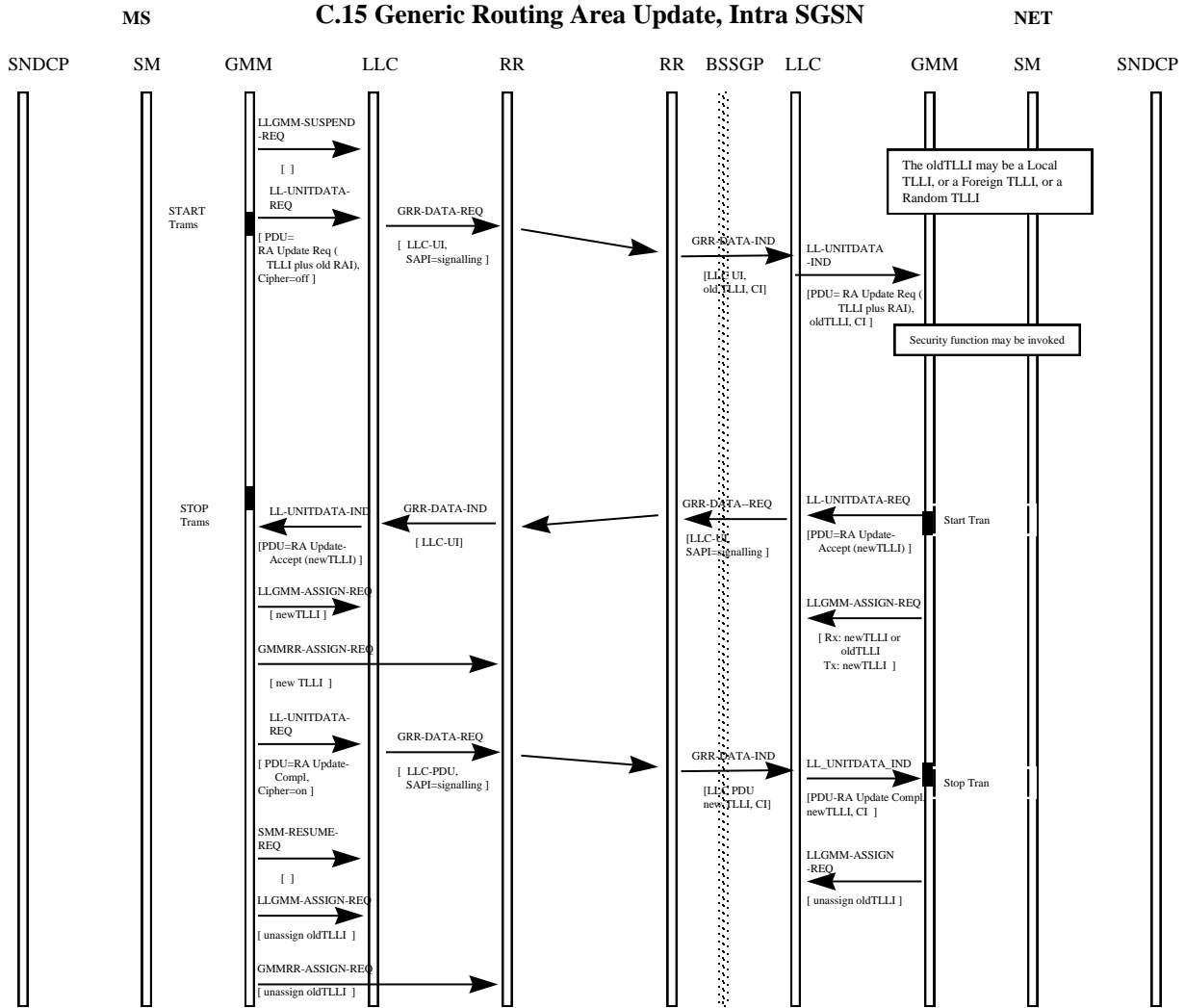
NOTE: The standalone PDP context modification procedure should use graceful disconnection of the LLC link

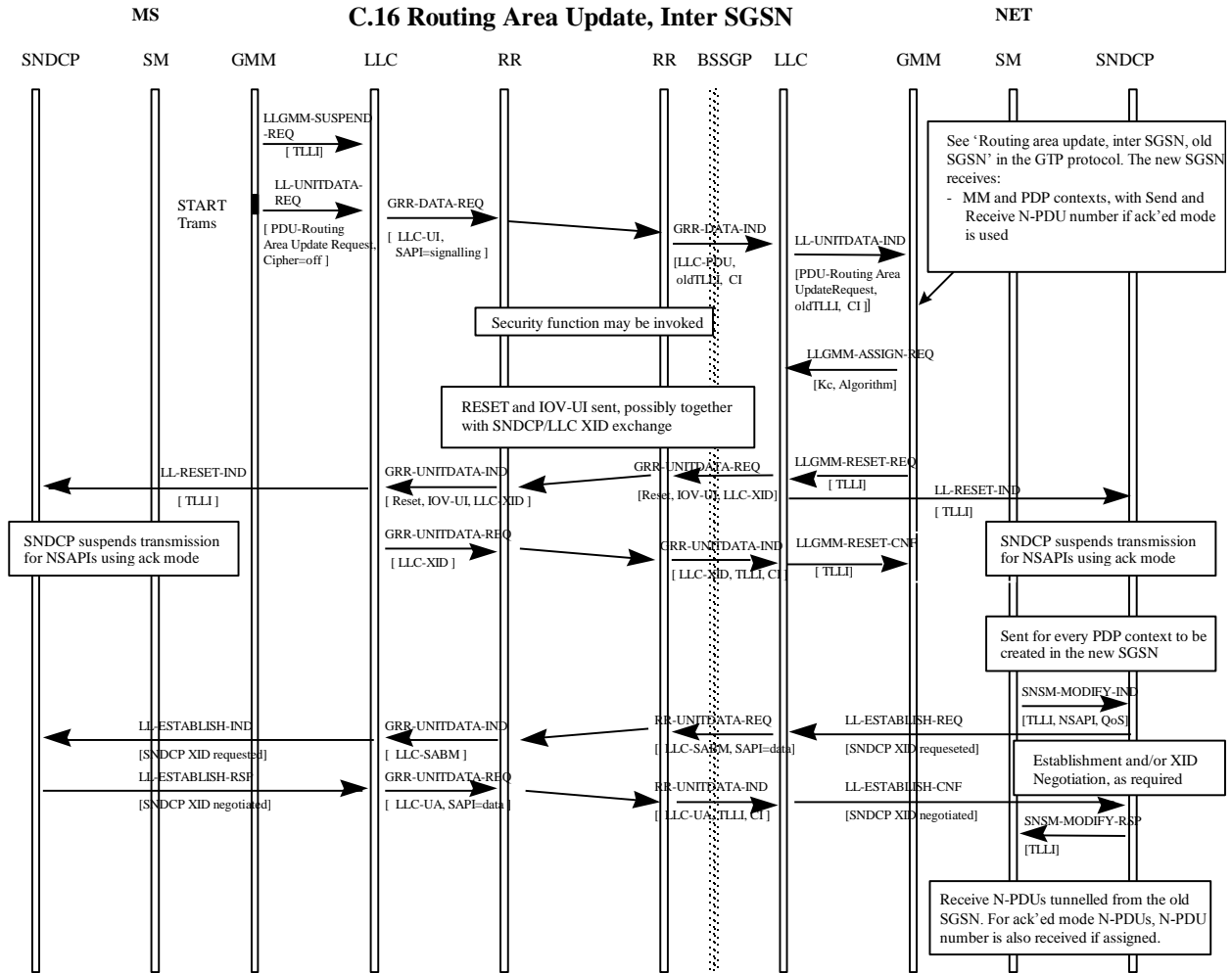




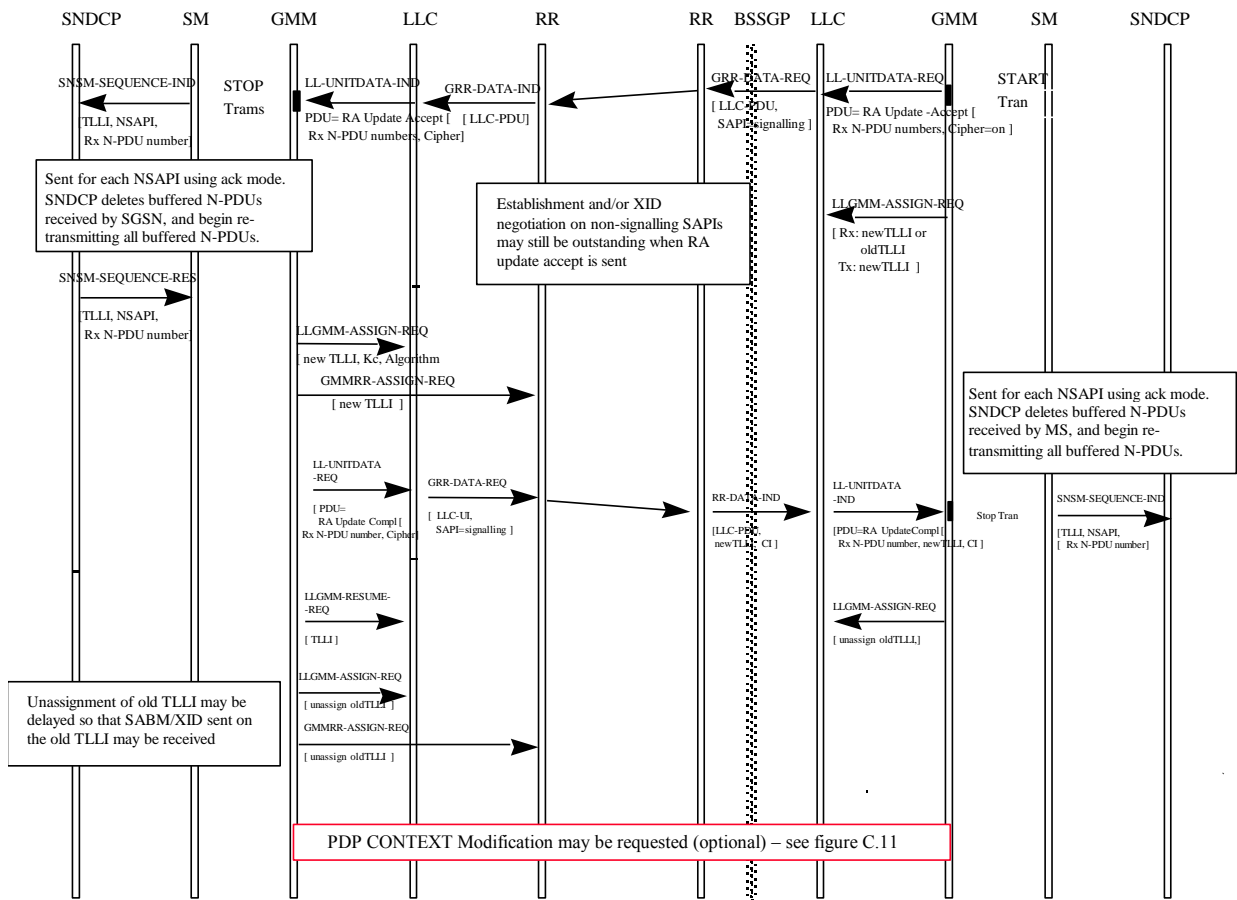


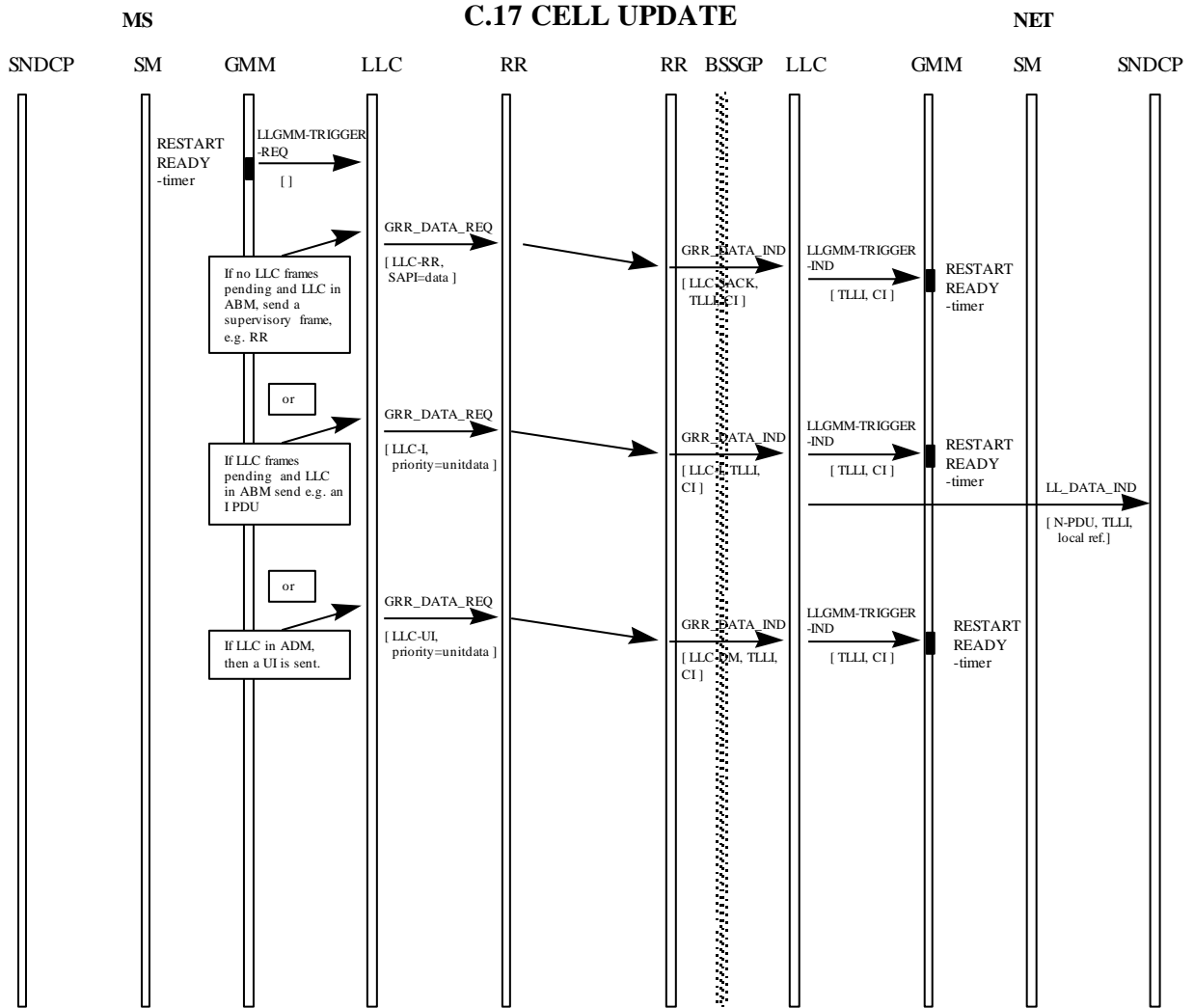






C.16(cont'd) Routing Area Update, Inter SGSN





## Annex D (informative): Change Request History

SMG#	CR	rev	phase	VERS	new_versions	SUBJECT
25	A015	1	R97	5.3.0	6.0.0	Page response parameter introduction between GMM-LLC-GRR
26	A014	1	R97	6.0.0	6.1.0	Primitives MMXX_PROMPT_IND, MMXX_PROMPT_REJ added
27	A019		R97	6.1.0	6.2.0	SNSM Primitives
27			R97	6.2.0	6.2.1	Correction of CR implementation
28	A017		R97	6.2.1	6.3.0	Introduction of Service primitives for the GMMSMS-SAP
28	A020		R97	6.2.1	6.3.0	Enhancement to CSN.1 Definition in 04.07 Annex B
28	A021	1	R97	6.2.1	6.3.0	Inter-SGSN RA update
28	A022	1	R98	6.2.1	7.0.0	Addition of CTS features
29	A034		R98	7.0.0	7.1.0	LCS Synchronisation requirements ( was approved as A020)
29	A025		R98	7.0.0	7.1.0	Inconsistency in definition of comprehension required IEs
29	A030		R98	7.0.0	7.1.0	Inter-SGSN RA update
30	A032	2	R98	7.1.0	7.2.0	Addition of LL-STATUS-IND
CN#6	A035		R98	7.2.0	7.3.0	Modifications for LCS enhancements

---

## History

<b>Document history</b>		
V7.1.0	August 1999	Publication
V7.3.0	December 1999	Publication